

Mechanical Dimensions: Inches [mm]

Tolerances ± 0.012 [0.3] Unless Otherwise Specified

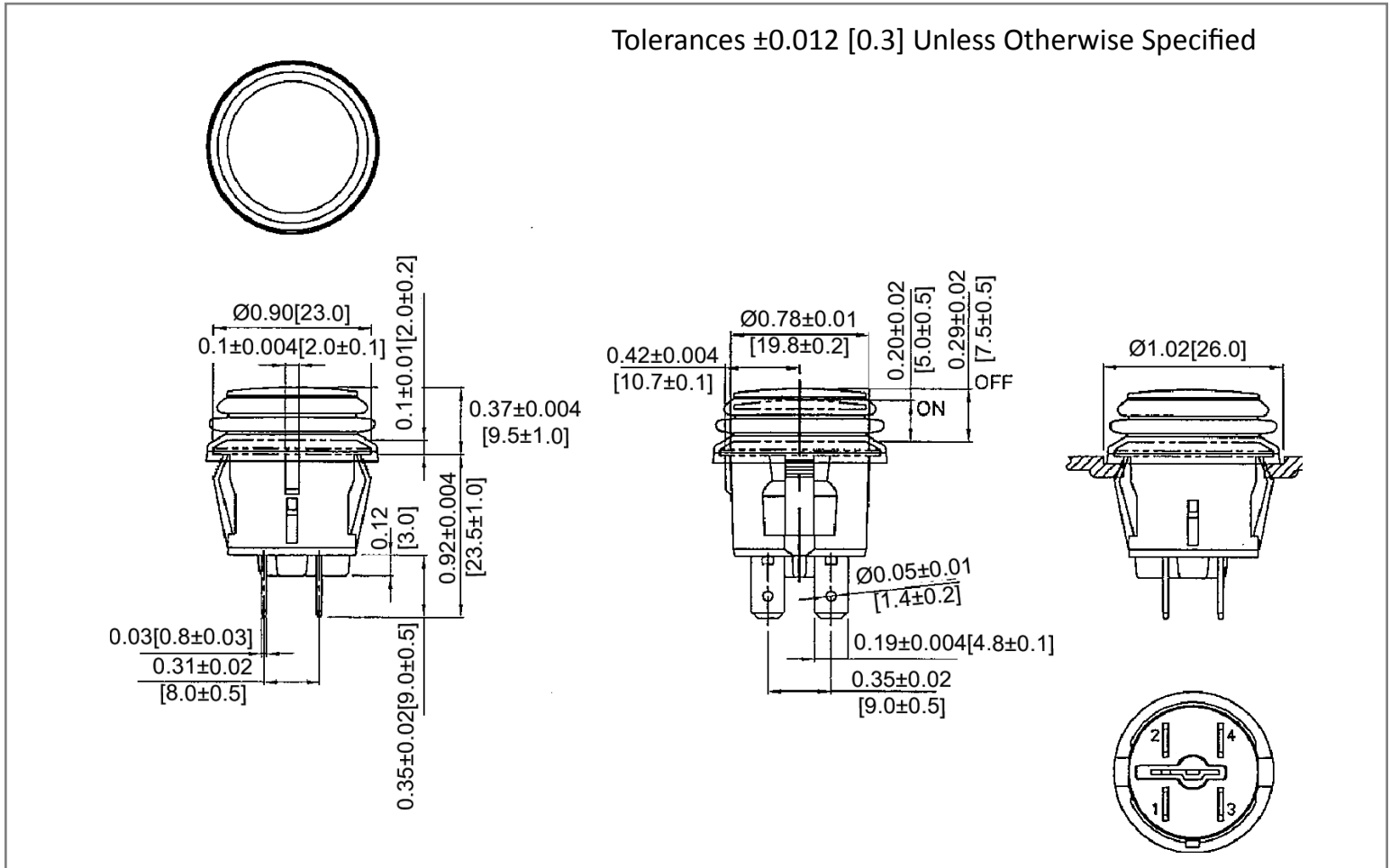

Mounting Hole

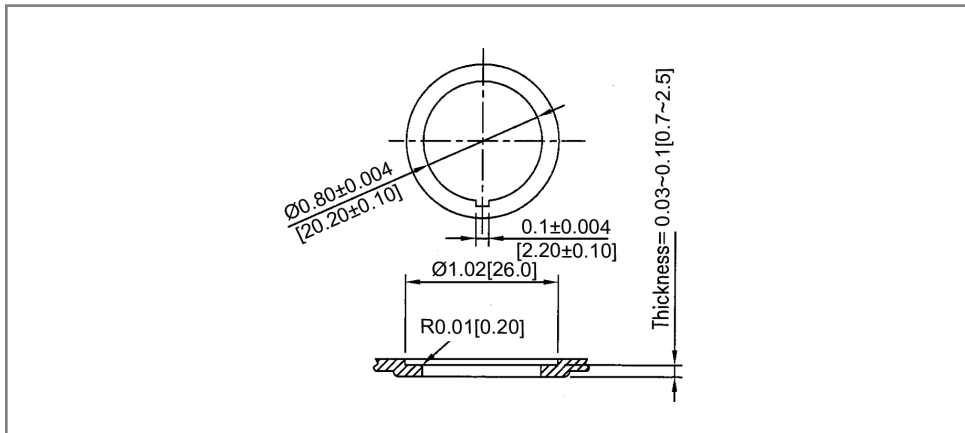

Circuit Diagram

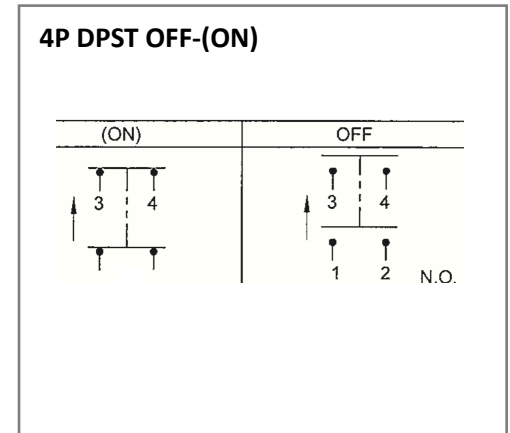

Electrical Specifications

Rating	10(4)A 125/250V AC 10A 125V AC, 6A 250V AC, 1/2HP 125V-250V AC
Contact Resistance	50m ohm Max.
Insulation Resistance	DC 500V 100M ohm Min
Dielectric Strength	AC 1500V 1 minute
Operation Temperature	-25°C ~ 85°C

Material Specifications

Frame	Black, Nylon 66 (94-V2)
Actuator	Black, PC (94-V2)
Terminals	Silver Plated, Copper Alloy
Waterproof Rubber	Black, Silicone
Waterproof	IP65

Rev **Date of issue** **Revision Notes**

Designed **Approved**

A	05-18-2021	Initial Drawing	RC	OF
---	------------	-----------------	----	----