



V36SE Series 1/16th Brick DC/DC Power Modules 18~75Vin, up to 50W

V36SE Series, 1/16th Brick, 18~75V wide input, single output, isolated DC/DC converter, is the latest offering from a world leader in power systems technology and manufacturing — Delta Electronics, Inc. This product family provides up to 50 watts of power in the industry standard 1/16th brick form factor (1.30"x0.90") and pinout. With creative design technology and optimization of component placement, these converters possess outstanding electrical and thermal performance, as well as extremely high reliability under highly stressful operating conditions. For the 5.0V output module, it delivers 50W(10A) output with 36 to 75V input and delivers 40W (8.0A) output while the input is 18 to 36V to the same module. Typical efficiency of the 5.0V/10A module is greater than 91%. All modules are protected from abnormal input/output voltage, current, and temperature conditions.

FEATURES

- High efficiency: 91%@5V/10A,48Vin
90%@5V/8A,24Vin
- Size: 33.0x22.8x9.3mm (1.30"x0.90"x0.37")
- Industry standard 1/16th brick size & pinout
- Input UVLO
- OTP and output OCP, OVP (default is auto-recovery)
- Output voltage trim: -20%, +10%
- Monotonic startup into normal and pre-biased loads
- 2250V isolation and basic insulation
- No minimum load required
- SMD and Through-hole versions
- ISO 9001, TL 9000, ISO 14001, QS 9000, OHSAS 18001 certified manufacturing facility
- IEC/EN/UL/CSA 62368-1, 2nd edition
- IEC/EN/UL/CSA 60950-1, 2nd edition+A2

OPTIONS

- Positive remote On/Off
- OTP and output OVP, OCP mode (Auto-restart or latch)

APPLICATIONS

- Optical Transport
- Data Networking
- Communications
- Servers

SOLDERING METHOD

- Wave soldering
- Hand soldering

TECHNICAL SPECIFICATIONS

($T_A=25^{\circ}\text{C}$, airflow rate=300 LFM, $V_{in}=48\text{Vdc}$, nominal V_{out} unless otherwise noted.)

PARAMETER	NOTES and CONDITIONS	V36SE05010(Standard)			
		Min.	Typ.	Max.	Units
ABSOLUTE MAXIMUM RATINGS					
Input Voltage					Vdc
Continuous				80	Vdc
Transient (100ms)	100ms			100	Vdc
Operating Temperature	Refer to figure 19 for measuring point	-40		119	$^{\circ}\text{C}$
Storage Temperature		-55		125	$^{\circ}\text{C}$
Input/Output Isolation Voltage				2250	Vdc
INPUT CHARACTERISTICS					
Operating Input Voltage		18	48	75	Vdc
Input Under-Voltage Lockout					
Turn-On Voltage Threshold		16	17	18	Vdc
Turn-Off Voltage Threshold		15	16	17	Vdc
Lockout Hysteresis Voltage		0.5	1	1.8	Vdc
Maximum Input Current	100% Load, 18Vin			3.9	A
No-Load Input Current			40		mA
Off Converter Input Current			8		mA
Inrush Current (I^2t)				1	A^2s
Input Reflected-Ripple Current	P-P thru 12 μH inductor, 5Hz to 20MHz		10		mA
Input Voltage Ripple Rejection	120 Hz		50		dB
OUTPUT CHARACTERISTICS					
Output Voltage Set Point	$V_{in}=48\text{V}$, $I_o=I_o.\text{max}$, $T_c=25^{\circ}\text{C}$	4.95	5.00	5.05	Vdc
Output Voltage Regulation					
Over Load	$I_o=I_o.\text{min}$ to $I_o.\text{max}$		± 3	± 10	mV
Over Line	$V_{in}=36\text{V}$ to 75V		± 3	± 10	mV
Over Temperature	$T_c=-40^{\circ}\text{C}$ to 85°C		± 50		mV
Total Output Voltage Range	Over sample load, line and temperature	4.85	5.00	5.15	V
Output Voltage Ripple and Noise	5Hz to 20MHz bandwidth				
Peak-to-Peak	Full Load, 1 μF ceramic, 100 μF tantalum		60		mV
RMS	Full Load, 1 μF ceramic, 100 μF tantalum		10		mV
Operating Output Current Range	$V_{in}=18\text{V}-36\text{V}$	0		8.0	A
Operating Output Current Range	$V_{in}=36\text{V}-75\text{V}$	0		10.0	A
Output Over Current Protection	Output Voltage 10% Low	110		140	%
DYNAMIC CHARACTERISTICS					
Output Voltage Current Transient	48V, 10 μF Tan & 1 μF Ceramic load cap, 0.1A/ μs				
Positive Step Change in Output Current	25% $I_o.\text{max}$ to 50% $I_o.\text{max}$		100		mV
Negative Step Change in Output Current	50% $I_o.\text{max}$ to 25% $I_o.\text{max}$		100		mV
Settling Time (within 1% V_{out} nominal)			200		μs
Turn-On Transient					
Start-Up Time, From On/Off Control			30		ms
Start-Up Time, From Input			30		ms
Maximum Output Capacitance (note1)	Full load; 5% overshoot of V_{out} at startup			5000	μF
EFFICIENCY					
100% Load	$V_{in}=48\text{V}$		91.0		%
100% Load	$V_{in}=24\text{V}$		90.0		%
60% Load	$V_{in}=48\text{V}$		90.0		%
ISOLATION CHARACTERISTICS					
Input to Output				2250	Vdc
Isolation Resistance		10			M Ω
Isolation Capacitance			1000		pF
FEATURE CHARACTERISTICS					
Switching Frequency			580		KHz
ON/OFF Control, Negative Remote On/Off logic					
Logic Low (Module On)	$V_{on/off}$			0.8	V
Logic High (Module Off)	$V_{on/off}$	2.4		18	V
ON/OFF Control, Positive Remote On/Off logic					
Logic Low (Module Off)	$V_{on/off}$			0.8	V
Logic High (Module On)	$V_{on/off}$	2.4		18	V
ON/OFF Current (for both remote on/off logic)	$I_{on/off}$ at $V_{on/off}=0.0\text{V}$			1	mA
Leakage Current (for both remote on/off logic)	Logic High, $V_{on/off}=15\text{V}$				
Output Voltage Trim Range	$P_{out} \leq \text{max rated power}, I_o \leq I_o.\text{max}$	-20		10	%
Output Voltage Remote Sense Range	$P_{out} \leq \text{max rated power}, I_o \leq I_o.\text{max}$			10	%
Output Over-Voltage Protection	Over full temp range; % of nominal V_{out}	115		140	%
GENERAL SPECIFICATIONS					
MTBF	$I_o=80\%$ of $I_o.\text{max}$; $T_a=25^{\circ}\text{C}$, airflow		5.1		M hours
Weight			12.1		grams
Over-Temperature Shutdown	Refer to figure 19 for measuring point		129		$^{\circ}\text{C}$

Note1: For applications with higher output capacitive load, please contact Delta

ELECTRICAL CHARACTERISTICS CURVES

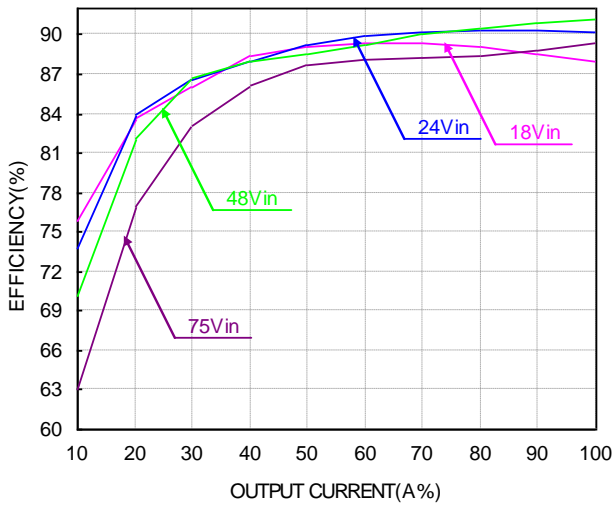

Figure 1: Efficiency vs. load current for minimum, nominal, and maximum input voltage at 25°C
18V~36VIN, I_{max} is 8A, 36V~75VIN, I_{max} is 10A

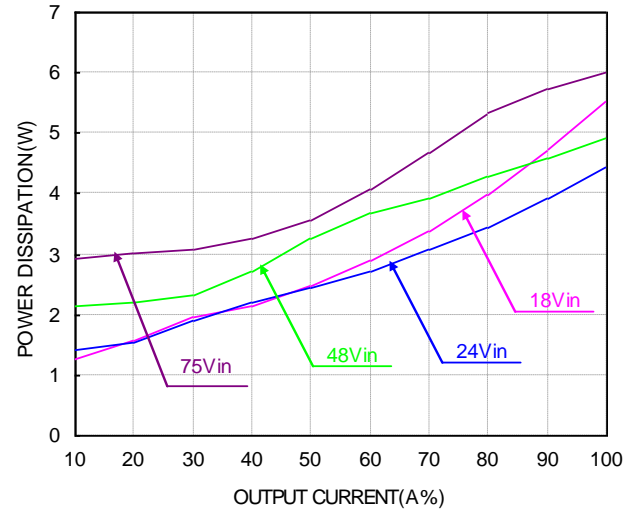

Figure 2: Power dissipation vs. load current for minimum, nominal, and maximum input voltage at 25°C.
18V~36VIN, I_{max} is 8A, 36V~75VIN, I_{max} is 10A

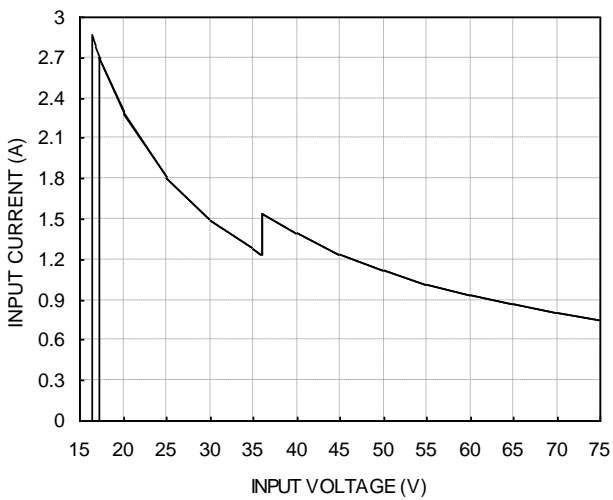

Figure 3: Typical full load input characteristics at room temperature

ELECTRICAL CHARACTERISTICS CURVES

For Negative Remote On/Off Logic

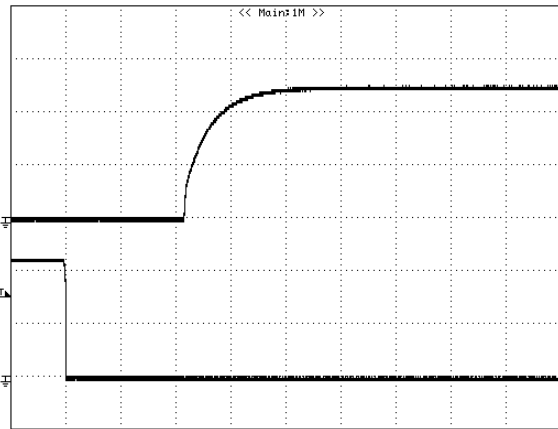

Figure 4: Turn-on transient at full rated load current (resistive load) (10 ms/div). $V_{in}=48V$. Top Trace: V_{out} , 2.0V/div; Bottom Trace: ON/OFF input, 2V/div

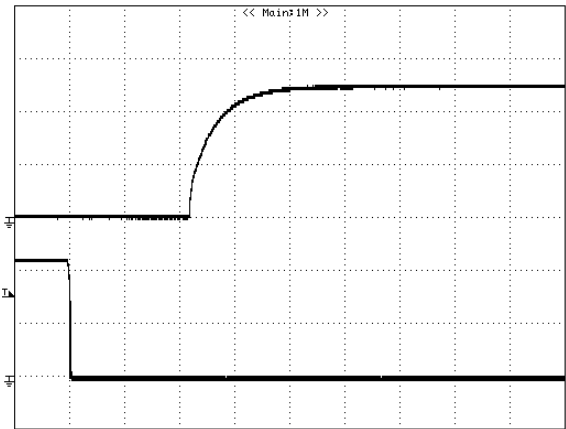

Figure 5: Turn-on transient at zero load current (10 ms/div). $V_{in}=48V$. Top Trace: V_{out} : 2.0V/div, Bottom Trace: ON/OFF input, 2V/div

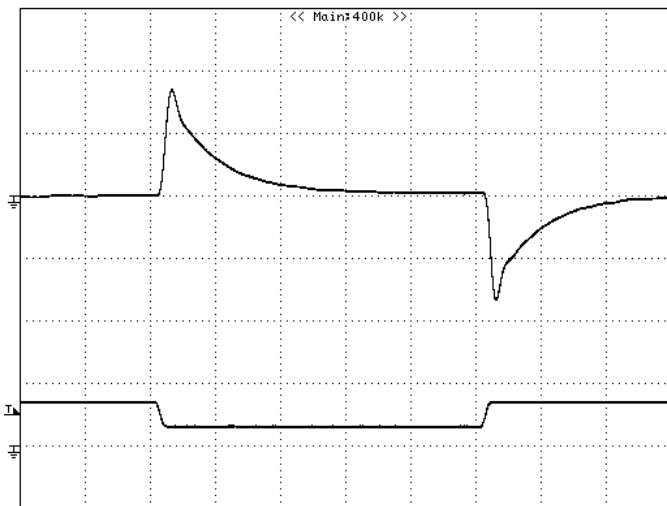

Figure 6: Output voltage response to step-change in load current (50%-25%-50% of $I_{o, max}$; $di/dt = 0.1A/\mu s$; V_{in} is 24v). Load cap: 10 μF tantalum capacitor and 1 μF ceramic capacitor. Top Trace: V_{out} (50mV/div, 200us/div), Bottom Trace: I_{out} (5A/div). Scope measurement should be made using a BNC cable (length shorter than 20 inches). Position the load between 51 mm to 76 mm (2 inches to 3 inches) from the module

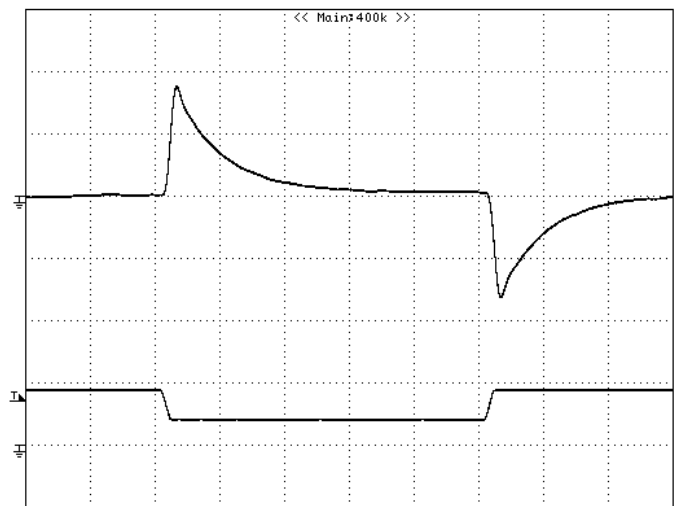

Figure 7: Output voltage response to step-change in load current (50%-25%-50% of $I_{o, max}$; $di/dt = 0.1A/\mu s$; V_{in} is 48v). Load cap: 10 μF tantalum capacitor and 1 μF ceramic capacitor. Top Trace: V_{out} (50mV/div, 200us/div), Bottom Trace: I_{out} (5A/div). Scope measurement should be made using a BNC cable (length shorter than 20 inches). Position the load between 51 mm to 76 mm (2 inches to 3 inches) from the module

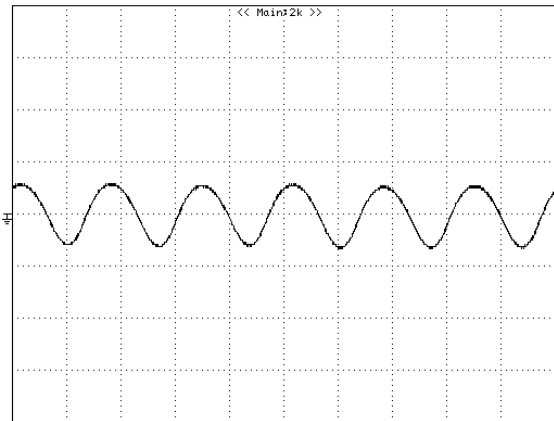
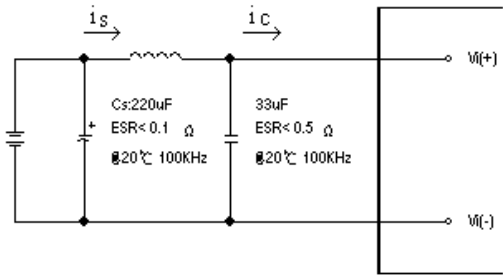

Figure 8: Test set-up diagram showing measurement points for Input Terminal Ripple Current and Input Reflected Ripple Current.
 Note: Measured input reflected-ripple current with a simulated source Inductance (L_{TEST}) of $12\ \mu\text{H}$. Capacitor C_s offset possible battery impedance. Measure current as shown above

Figure 9: Input Terminal Ripple Current, i_c , at full rated output current and nominal input voltage ($V_{in}=48\text{v}$) with $12\ \mu\text{H}$ source impedance and $33\ \mu\text{F}$ electrolytic capacitor (200 mA/div, 1us/div)

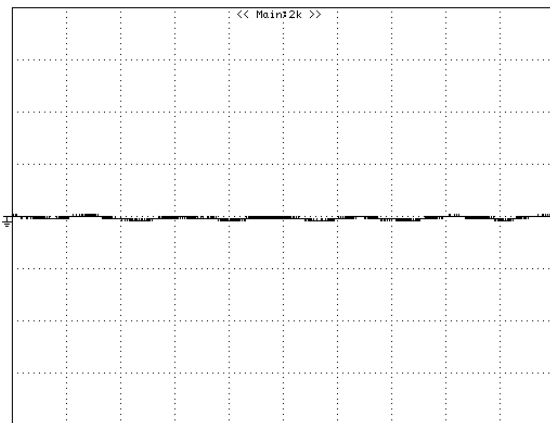

Figure 10: Input reflected ripple current, i_s , through a $12\ \mu\text{H}$ source inductor at nominal input voltage ($v_{in}=48\text{v}$) and rated load current (20 mA/div, 1us/div)

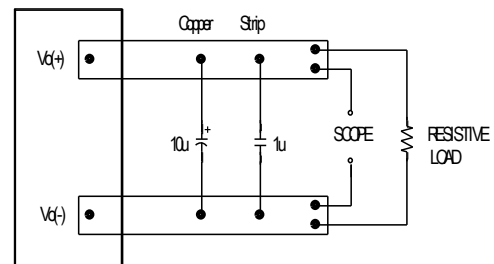

Figure 11: Output voltage noise and ripple measurement test setup

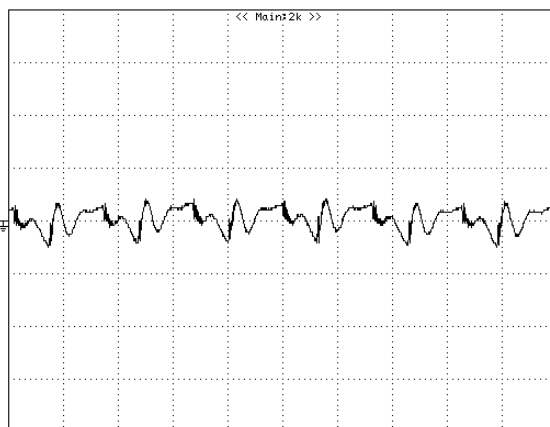

Figure 12: Output voltage ripple at nominal input voltage ($v_{in}=48\text{v}$) and rated load current ($I_o=10\text{A}$) (50 mV/div, 1us/div). Load capacitance: $1\ \mu\text{F}$ ceramic capacitor and $100\ \mu\text{F}$ tantalum capacitor. Bandwidth: 20 MHz. Scope measurements should be made using a BNC cable (length shorter than 20 inches). Position the load between 51 mm to 76 mm (2 inches to 3 inches) from the module

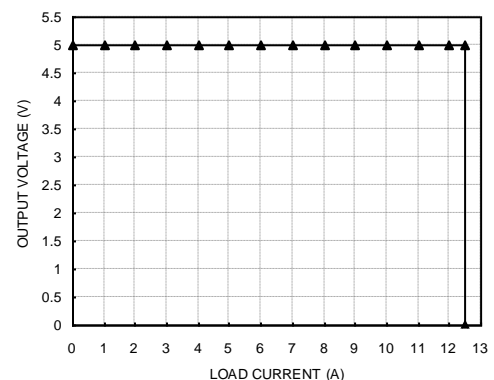

Figure 13: Output voltage vs. load current showing typical current limit curves and converter shutdown points ($V_{in}=48\text{v}$)

Input Source Impedance

The impedance of the input source connecting to the DC/DC power modules will interact with the modules and affect the stability. A low ac-impedance input source is recommended. If the source inductance is more than a few μH , we advise adding a 10 to 100 μF electrolytic capacitor (ESR < 0.7 Ω at 100 kHz) mounted close to the input of the module to improve the stability.

Layout and EMC Considerations

Delta's DC/DC power modules are designed to operate in a wide variety of systems and applications. Below is a reference design for an input filter tested with V36SE05010XXXX to meet class B in CISPR 22.

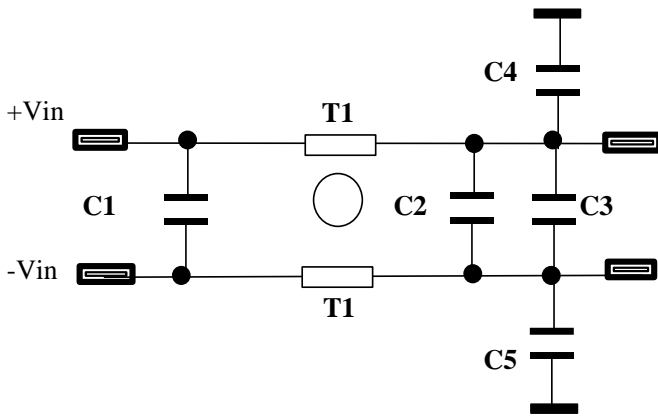

C1=3.3 μF /100 V ceramic cap
 C2+C3= 100 μF /100 V low ESR Aluminum cap
 C4=C5=1nF ceramic cap
 T1=3 mH

Test Result: Vin=48V, Io=10A

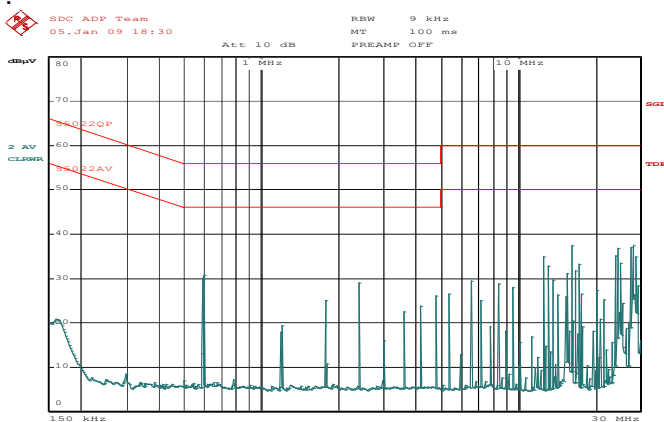

Average Mode

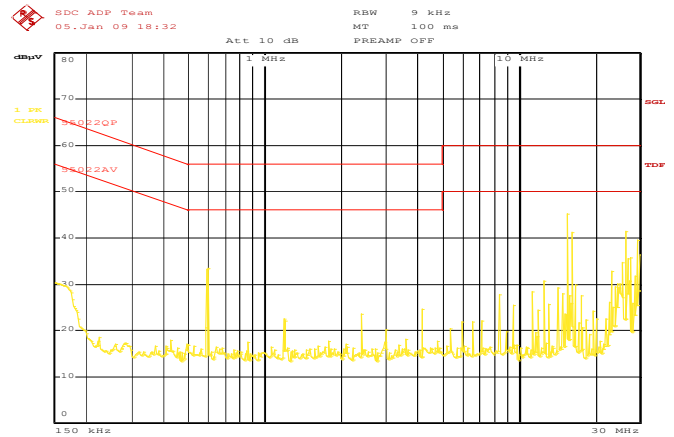

Peak Mode

Safety Considerations

The power module must be installed in compliance with the spacing and separation requirements of the end-user's safety agency standard, i.e. IEC 62368-1: 2014 (2nd edition), EN 62368-1: 2014 (2nd edition), UL 62368-1, 2nd Edition, 2014-12-01 and CSA C22.2 No. 62368-1-14, 2nd Edition, 2014-12. IEC 60950-1: 2005, 2nd Edition + A1: 2009 + A2: 2013, EN 60950-1: 2006 + A11: 2009 + A1: 2010 + A12: 2011 + A2: 2013, UL 60950-1, 2nd Edition, 2011-10-14 and CSA C22.2 No. 60950-1-07, 2nd Edition, 2010-14, if the system in which the power module is to be used must meet safety agency requirements.

Basic insulation based on 75 Vdc input is provided between the input and output of the module for the purpose of applying insulation requirements when the input to this DC-to-DC converter is identified as TNV-2 or SELV. An additional evaluation is needed if the source is other than TNV-2 or SELV.

When the input source is SELV circuit, the power module meets SELV (safety extra-low voltage) requirements. If the input source is a hazardous voltage which is greater than 60 Vdc and less than or equal to 75 Vdc, for the module's output to meet SELV requirements, all of the following must be met:

- The input source must be insulated from the ac mains by reinforced or double insulation.
- The input terminals of the module are not operator accessible.
- If the metal baseplate is grounded, one Vi pin and one Vo pin shall also be grounded.
- A SELV reliability test is conducted on the system where the module is used, in combination with the module, to ensure that under a single fault, hazardous voltage does not appear at the module's output.



When installed into a Class II equipment (without grounding), spacing consideration should be given to the end-use installation, as the spacing between the module and mounting surface have not been evaluated.

The power module has extra-low voltage (ELV) outputs when all inputs are ELV.

This power module is not internally fused. To achieve optimum safety and system protection, an input line fuse is highly recommended. The safety agencies require a normal-blow fuse with 10A maximum rating to be installed in the ungrounded lead. A lower rated fuse can be used based on the maximum inrush transient energy and maximum input current.

Soldering and Cleaning Considerations

Post solder cleaning is usually the final board assembly process before the board or system undergoes electrical testing. Inadequate cleaning and/or drying may lower the reliability of a power module and severely affect the finished circuit board assembly test. Adequate cleaning and/or drying is especially important for un-encapsulated and/or open frame type power modules. For assistance on appropriate soldering and cleaning procedures, please contact Delta's technical support team.

Over-Current Protection

The modules include an internal output over-current protection circuit, which will endure current limiting for an unlimited duration during output overload. If the output current exceeds the OCP set point, the modules will automatically shut down, and enter hiccup mode or latch mode, which is optional.

For hiccup mode, the module will try to restart after shutdown. If the over current condition still exists, the module will shut down again. This restart trial will continue until the over-current condition is corrected.

For latch mode, the module will latch off once it shutdown. The latch is reset by either cycling the input power or by toggling the on/off signal for one second.

Over-Voltage Protection

The modules include an internal output over-voltage protection circuit, which monitors the voltage on the output terminals. If this voltage exceeds the over-voltage set point, the module will shut down, and enter in hiccup mode or latch mode, which is optional.

For hiccup mode, the module will try to restart after shutdown. If the over voltage condition still exists, the module will shut down again. This restart trial will continue until the over-voltage condition is corrected.

For latch mode, the module will latch off once it shutdown. The latch is reset by either cycling the input power or by toggling the on/off signal for one second.

Over-Temperature Protection

The over-temperature protection consists of circuitry that provides protection from thermal damage. If the temperature exceeds the over-temperature threshold the module will shut down, and enter in hiccup mode or latch mode, which is optional.

For hiccup mode, the module will try to restart after shutdown. If the over temperature condition still exists, the module will shut down again. This restart trial will continue until the over-temperature condition is corrected.

For latch mode, the module will latch off once it shutdown. The latch is reset by either cycling the input power or by toggling the on/off signal for one second.

Remote On/Off

The remote on/off feature on the module can be either negative or positive logic. Negative logic turns the module on during a logic low and off during a logic high. Positive logic turns the modules on during a logic high and off during a logic low.

Remote on/off can be controlled by an external switch between the on/off terminal and the Vi(-) terminal. The switch can be an open collector or open drain.

For negative logic if the remote on/off feature is not used, please short the on/off pin to Vi(-). For positive logic if the remote on/off feature is not used, please leave the on/off pin floating.

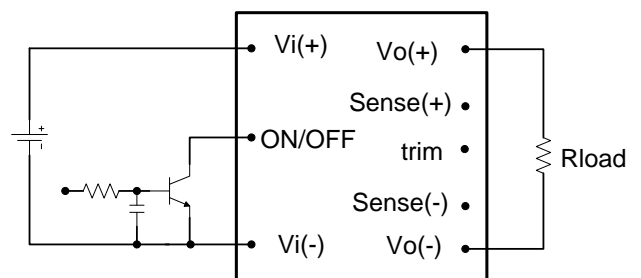

Figure 14: Remote on/off implementation

Remote Sense

Remote sense compensates for voltage drops on the output by sensing the actual output voltage at the point of load. The voltage between the remote sense pins and the output terminals must not exceed the output voltage sense range given here:

$$[Vo(+) - Vo(-)] - [SENSE(+) - SENSE(-)] \leq 10\% \times V_{out}$$

This limit includes any increase in voltage due to remote sense compensation and output voltage set point adjustment (trim).

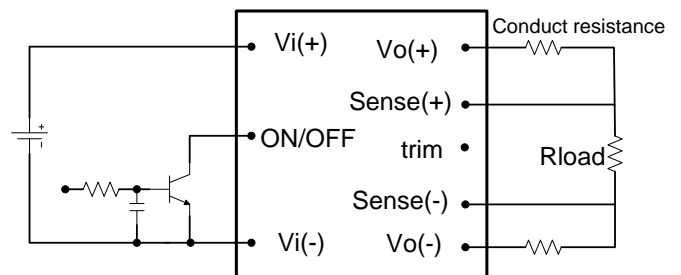

Figure 15: Effective circuit configuration for remote sense operation

FEATURES DESCRIPTIONS (CON.)

If the remote sense feature is not used to regulate the output at the point of load, please connect SENSE(+) to Vo(+) and SENSE(-) to Vo(-) at the module.

The output voltage can be increased by both the remote sense and the trim; however, the maximum increase is the larger of either the remote sense or the trim, not the sum of both.

When using remote sense and trim, the output voltage of the module is usually increased, which increases the power output of the module with the same output current.

Care should be taken to ensure that the maximum output power does not exceed the maximum rated power.

Output Voltage Adjustment (TRIM)

To increase or decrease the output voltage set point, connect an external resistor between the TRIM pin and either the SENSE(+) or SENSE(-). The TRIM pin should be left open if this feature is not used.

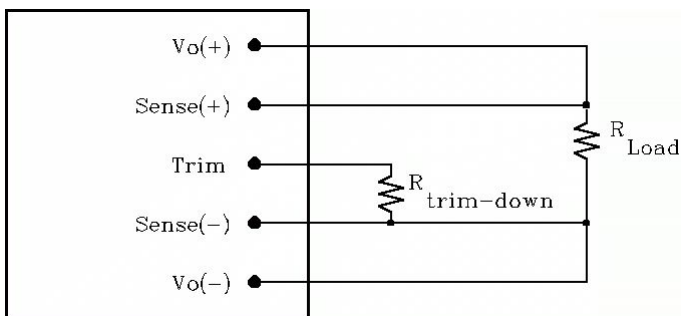

Figure 16: Circuit configuration for trim-down (decrease output voltage)

If the external resistor is connected between the TRIM and SENSE (-) pins, the output voltage set point decreases (Fig. 16). The external resistor value required to obtain a percentage of output voltage change $\Delta\%$ is defined as:

$$R_{trim-down} = \left[\frac{511}{\Delta} - 10.22 \right] (K\Omega)$$

Ex. When Trim-down -20% ($5.0V \times 0.8 = 4.0V$)

$$R_{trim-down} = \left[\frac{511}{20} - 10.22 \right] (K\Omega) = 15.33(K\Omega)$$

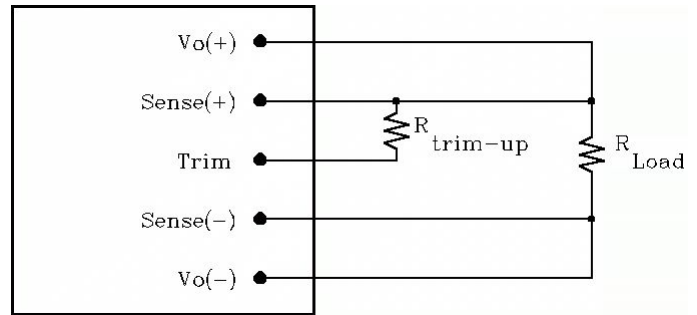

Figure 17: Circuit configuration for trim-up (increase output voltage)

If the external resistor is connected between the TRIM and SENSE (+) the output voltage set point increases (Fig. 17). The external resistor value required to obtain a percentage output voltage change $\Delta\%$ is defined as:

$$R_{trim-up} = \frac{5.11V_o(100+\Delta)}{1.24\Delta} - \frac{511}{\Delta} - 10.22(K\Omega)$$

Ex. When Trim-up +10% ($5.0V \times 1.1 = 5.5V$)

$$R_{trim-up} = \frac{5.11 \times 5.0 \times (100+10)}{1.24 \times 10} - \frac{511}{10} - 10.22 = 165.33(K\Omega)$$

The output voltage can be increased by both the remote sense and the trim, however the maximum increase is the larger of either the remote sense or the trim, not the sum of both.

When using remote sense and trim, the output voltage of the module is usually increased, which increases the power output of the module with the same output current.

Care should be taken to ensure that the maximum output power of the module remains at or below the maximum rated power.

THERMAL CONSIDERATIONS

Thermal management is an important part of the system design. To ensure proper, reliable operation, sufficient cooling of the power module is needed over the entire temperature range of the module. Convection cooling is usually the dominant mode of heat transfer.

Hence, the choice of equipment to characterize the thermal performance of the power module is a wind tunnel.

Thermal Testing Setup

Delta's DC/DC power modules are characterized in heated vertical wind tunnels that simulate the thermal environments encountered in most electronics equipment. This type of equipment commonly uses vertically mounted circuit cards in cabinet racks in which the power modules are mounted.

The following figure shows the wind tunnel characterization setup. The power module is mounted on a test PWB and is vertically positioned within the wind tunnel. The space between the neighboring PWB and the top of the power module is constantly kept at 6.35mm (0.25").

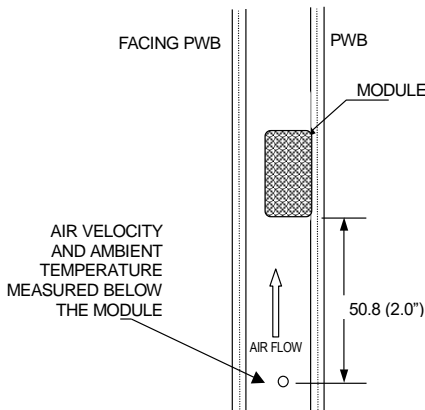

Note: Wind Tunnel Test Setup Figure Dimensions are in millimeters and (Inches)

Figure 18: Wind tunnel test setup

Thermal Derating

Heat can be removed by increasing airflow over the module. To enhance system reliability, the power module should always be operated below the maximum operating temperature. If the temperature exceeds the maximum module temperature, reliability of the unit may be affected.

THERMAL CURVES

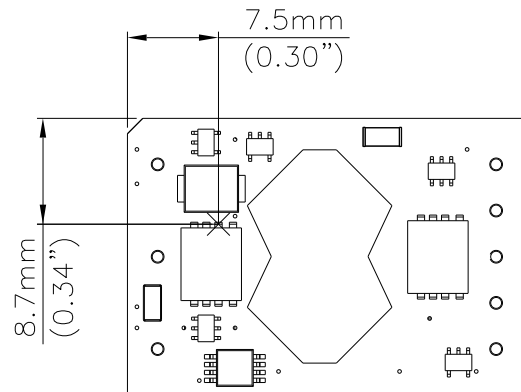

Figure 19: Temperature measurement location

* The allowed maximum hot spot temperature is defined at 119°C.

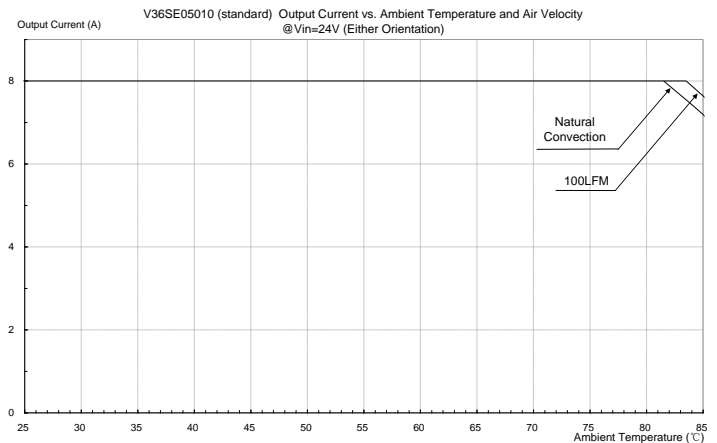

Figure 20: Output current vs. ambient temperature and air velocity @ $V_{in}=24V$ (Either Orientation)

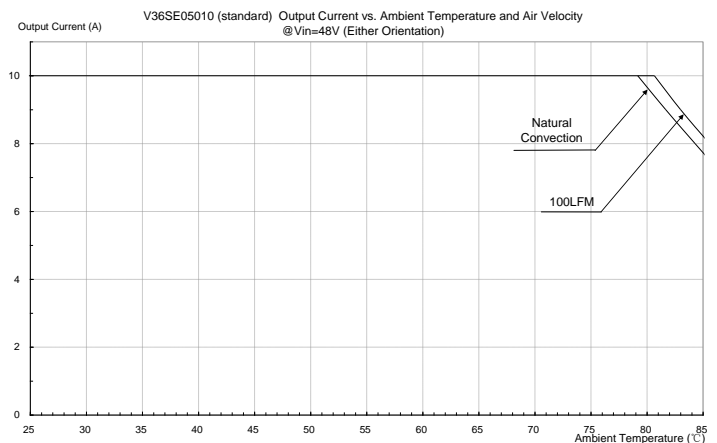
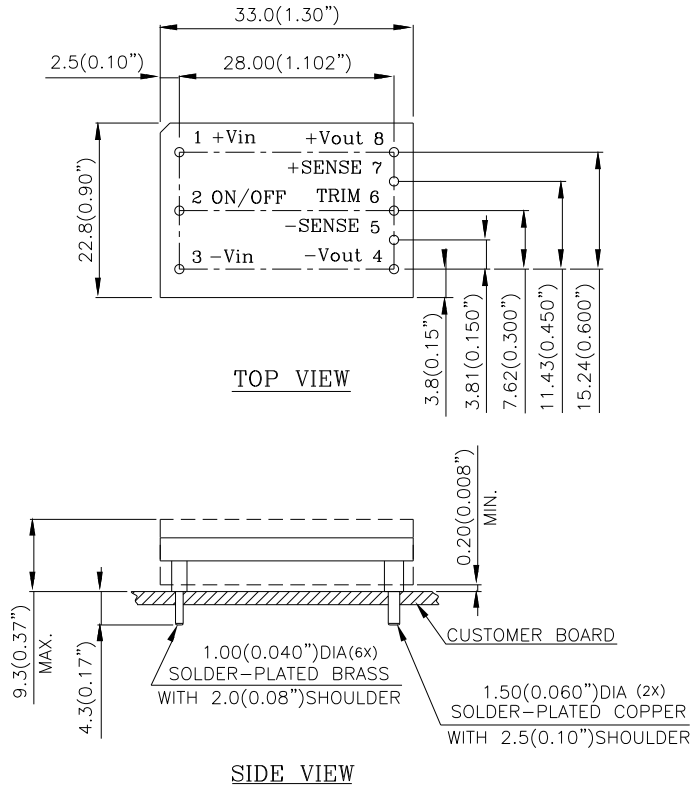

Figure 21: Output current vs. ambient temperature and air velocity @ $V_{in}=48V$ (Either Orientation)

Through-hole module



NOTES:
 DIMENSIONS ARE IN MILLIMETERS AND (INCHES)
 TOLERANCES: X.Xmm±0.5mm(X.XX in.±0.02 in.)
 X.XXmm±0.25mm(X.XXX in.±0.010 in.)

<u>Pin No.</u>	<u>Name</u>	<u>Function</u>
1	+Vin	Positive input voltage
2	ON/OFF	Remote ON/OFF
3	-Vin	Negative input voltage
4	-Vout	Negative output voltage
5	-SENSE	Negative remote sense
6	TRIM	Output voltage trim
7	+SENSE	Positive remote sense
8	+Vout	Positive output voltage

SOLDERING METHOD

Generally, as the most common mass soldering method for the solder attachment, wave soldering is used for through-hole power modules and reflow soldering is used for surface-mount ones. Delta recommended soldering methods and process parameters are provided in this document for solder attachment of power modules onto system board. SAC305 is the suggested lead-free solder alloy for all soldering methods. The soldering temperature profile presented in this document is based on SAC305 solder alloy.

Reflow soldering is not a suggested method for through-hole power modules due to many process and reliability concerns. If you have this kind of application requirement, please contact Delta sales or FAE for further confirmation.

Wave Soldering (Lead-free)

Delta's power modules are designed to be compatible with single-wave or dual wave soldering. The suggested soldering process must keep the power module's internal temperature below the critical temperature of 217°C continuously. The recommended wave-soldering profile is shown below:

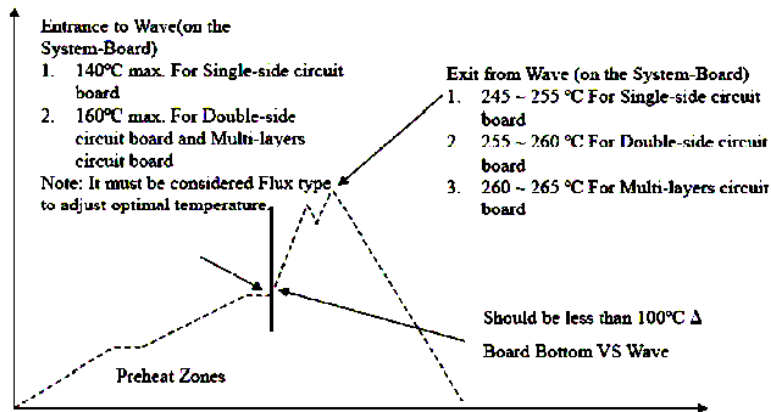

Note: The temperature is measured on solder joint of pins of power module.

The typical recommended (for double-side circuit board) preheat temperature is 115+/-10°C on the top side (component side) of the circuit board. The circuit-board bottom-side preheat temperature is typically recommended to be greater than 135°C and preferably within 100°C of the solder-wave temperature. A maximum recommended preheat up rate is 3°C /s. A maximum recommended solder pot temperature is 255+/-5°C with solder-wave dwell time of 3~6 seconds. The cooling down rate is typically recommended to be 6°C/s maximum.

Hand Soldering (Lead Free)

Hand soldering is the least preferred method because the amount of solder applied, the time the soldering iron is held on the joint, the temperature of the iron, and the temperature of the solder joint are variable. The recommended hand soldering guideline is listed in Table below. The suggested soldering process must keep the power module's internal temperature below the critical temperature of 217°C continuously.

Parameter	Single-side Circuit Board	Double-side Circuit Board	Multi-layers Circuit Board
Soldering Iron Wattage	90	90	90
Tip Temperature	385+/-10°C	420+/-10°C	420+/-10°C
Soldering Time	2 ~ 6 seconds	4 ~ 10 seconds	4 ~ 10 seconds



PART NUMBERING SYSTEM

V	36	S	E	050	10	N	R	F	A
Type of Product	Input Voltage	Number of Outputs	Product Series	Output Voltage	Output Current	ON/OFF Logic	Pin Length/Type		Option Code
V - 1/16 Brick	36 - 18V~75V	S - Single	E - Regular	050 - 5V	10 - 10A	N- Negative	K - 0.110" N - 0.145" R - 0.170"	F - RoHS 6/6 (Lead Free)	A-Standard Functions

MODEL LIST

MODEL NAME	INPUT		OUTPUT		EFF @ 100% LOAD
V36SE05010NRFA	18V~75V	3.9A	5V	8A (18~36Vin) & 10A(36~75Vin)	90.0% @ 24Vin, 91.0% @ 48Vin
V36SE05010NNFA	18V~75V	3.9A	5V	8A (18~36Vin) & 10A(36~75Vin)	90.0% @ 24Vin, 91.0% @ 48Vin

CONTACT: www.deltaww.com/dcdc Email: dcdc@deltaww.com

USA:

Telephone:
East Coast: 978-656-3993
West Coast: 510-668-5100
Fax: 510-668-0680

Europe:

Telephone: +31-20-800-3900
Fax: +31-20-800-3999

Asia & the rest of world:

Telephone: +886-3-452-6107
Ext. 6221~6226
Fax: +886-3-433-1810

WARRANTY

Delta offers a two (2) year limited warranty. Complete warranty information is listed on our web site or is available upon request from Delta.

Information furnished by Delta is believed to be accurate and reliable. However, no responsibility is assumed by Delta for its use, nor for any infringements of patents or other rights of third parties, which may result from its use. No license is granted by implication or otherwise under any patent or patent rights of Delta. Delta reserves the right to revise these specifications at any time, without notice.