

THIS DRAWING IS UNPUBLISHED. RELEASED FOR PUBLICATION  
 © COPYRIGHT - By - ALL RIGHTS RESERVED.

REVISIONS					
P	LTR	DESCRIPTION	DATE	DWN	APVD
A2		ECR-18-004593	27MAR2018	GK	ES

PROJECT	PRJ-16-000909157
PART NO.	X-2308272-X
DESCRIPTION	CABLE CLAMPS
CUSTOMER	GENERAL MARKET

1-2308272-1

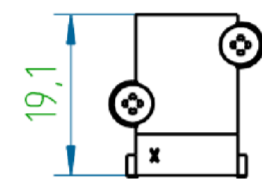
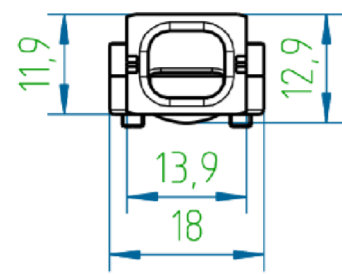

1-2308272-2

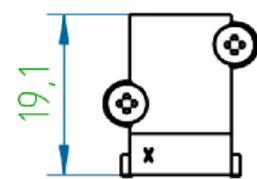
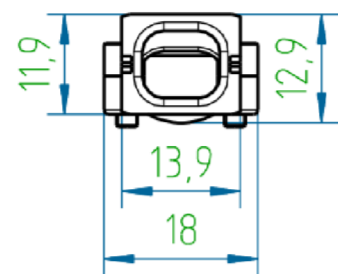

1-2308272-4

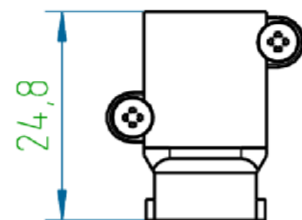
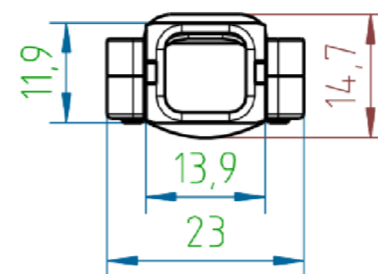

1-2308272-5

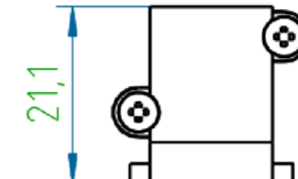
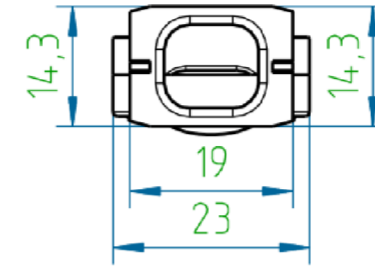

1-2308272-6

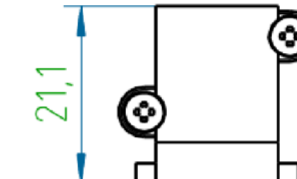
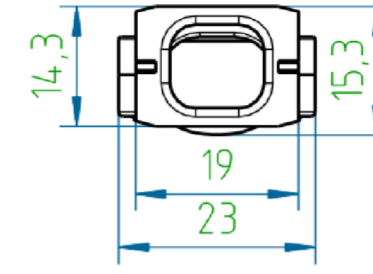

1-2308272-7

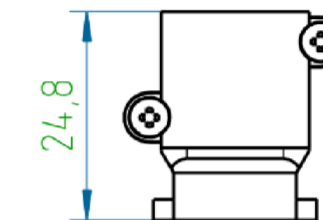
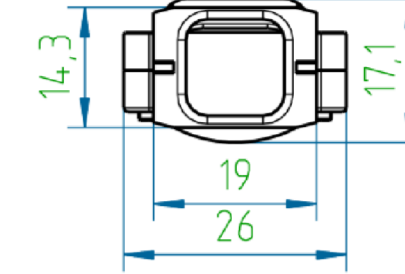

1-2308272-3

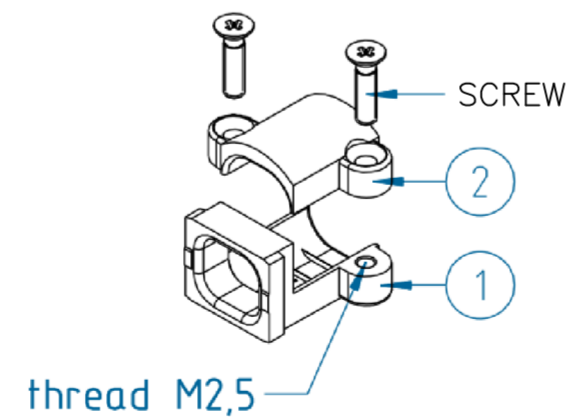
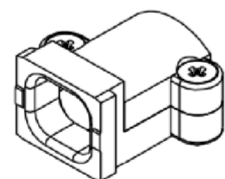
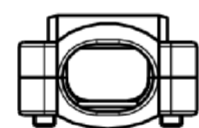
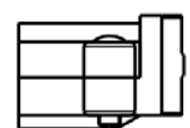
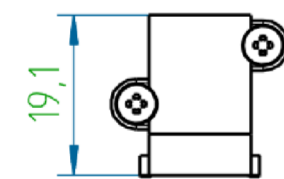
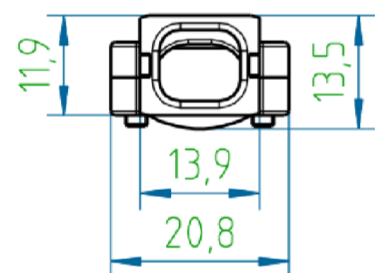

NOTES:

- FINISH:  
 1-2308272-1 TO 1-2308272-7 - CASE RAW.  
 1-2308272-8 TO 2-2308272-4 - CASE NICKEL-PLATED.
- SCREWS ZINC-PLATED.
- TEMPERATURE RANGE: -40°C TO +90°C.

THIS DRAWING IS A CONTROLLED DOCUMENT.		DWN KIRAN_K 26JUL2016		
DIMENSIONS: mm		CHK GUNASEKHAR_G 26JUL2016		
TOLERANCES UNLESS OTHERWISE SPECIFIED: DIN ISO 2768 m		APVD GUNASEKHAR_G 26JUL2016	NAME CABLE CLAMPS	
		PRODUCT SPEC	SIZE A2	
MATERIAL		APPLICATION SPEC	CAGE CODE 00779	DRAWING NO C-2308272
FINISH		WEIGHT	RESTRICTED TO	
		CUSTOMER DRAWING		SCALE NTS
		SHEET 1 OF 2		REV A2

THIS DRAWING IS UNPUBLISHED. RELEASED FOR PUBLICATION  
 © COPYRIGHT - By - ALL RIGHTS RESERVED.

REVISIONS				
P	LTR	DESCRIPTION	DATE	APVD
-	-	SEE SHEET 1	-	-

2-2308272-4	CABLE CLAMP7	CABLE CLAMP BOTTOM	CABLE CLAMP UPPER	5	125	14-16	9-10	7.5-8.5	6.5-8	20
2-2308272-3	CABLE CLAMP6	CABLE CLAMP BOTTOM	CABLE CLAMP UPPER	5	100	11-14	7-8	6-7	5-6.5	16
2-2308272-2	CABLE CLAMP5	CABLE CLAMP BOTTOM	CABLE CLAMP UPPER	5	100	8-10	5-7	4-5	-	21
2-2308272-1	CABLE CLAMP4	CABLE CLAMP BOTTOM	CABLE CLAMP UPPER	1-4	85	11-14	7-8	6-7	5-6	16
2-2308272-0	CABLE CLAMP3	CABLE CLAMP BOTTOM	CABLE CLAMP UPPER	1-4	75	9-12	6-7	5-6	4-5	12
1-2308272-9	CABLE CLAMP2	CABLE CLAMP BOTTOM	CABLE CLAMP UPPER	1-4	65	7-10	5-6	4-4.5	-	12
1-2308272-8	CABLE CLAMP1	CABLE CLAMP BOTTOM	CABLE CLAMP UPPER	1-4	65	4-7	4-5	3.5-4	-	14
PART NO: (CASE Ni-PLATED)	DESCRIPTION (CASE Ni-PLATED)	POS. 1	POS. 2	AVAILABLE IN THE HOODS SIZE	WINDOWS FOR LACES, mm?	1 CABLE	2 CABLE	3 CABLE	4 CABLE	WEIGHT, g
		SUB-PART DESCRIPTION				FOR CABLE DIAMETER, mm				

1-2308272-7	CABLE CLAMP7	CABLE CLAMP BOTTOM	CABLE CLAMP UPPER	5	125	14-16	9-10	7.5-8.5	6.5-8	20
1-2308272-6	CABLE CLAMP6	CABLE CLAMP BOTTOM	CABLE CLAMP UPPER	5	100	11-14	7-8	6-7	5-6.5	16
1-2308272-5	CABLE CLAMP5	CABLE CLAMP BOTTOM	CABLE CLAMP UPPER	5	100	8-10	5-7	4-5	-	21
1-2308272-4	CABLE CLAMP4	CABLE CLAMP BOTTOM	CABLE CLAMP UPPER	1-4	85	11-14	7-8	6-7	5-6	16
1-2308272-3	CABLE CLAMP3	CABLE CLAMP BOTTOM	CABLE CLAMP UPPER	1-4	75	9-12	6-7	5-6	4-5	12
1-2308272-2	CABLE CLAMP2	CABLE CLAMP BOTTOM	CABLE CLAMP UPPER	1-4	65	7-10	5-6	4-4.5	-	12
1-2308272-1	CABLE CLAMP1	CABLE CLAMP BOTTOM	CABLE CLAMP UPPER	1-4	65	4-7	4-5	3.5-4	-	14
PART NO: (CASE RAW)	DESCRIPTION (CASE RAW)	POS. 1	POS. 2	AVAILABLE IN THE HOODS SIZE	WINDOWS FOR LACES, mm?	1 CABLE	2 CABLE	3 CABLE	4 CABLE	WEIGHT, g
		SUB-PART DESCRIPTION				FOR CABLE DIAMETER, mm				

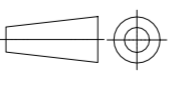
THIS DRAWING IS A CONTROLLED DOCUMENT.		DWN KIRAN K 26JUL2016	<b>STE</b> TE Connectivity	
DIMENSIONS: mm		CHK GUNASEKHAR G 26JUL2016		
TOLERANCES UNLESS OTHERWISE SPECIFIED: DIN ISO 2768 m		APVD GUNASEKHAR G 26JUL2016	NAME CABLE CLAMPS	
		PRODUCT SPEC -	SIZE A2	
MATERIAL -		APPLICATION SPEC -	CAGE CODE 00779	DRAWING NO C-2308272
FINISH -		WEIGHT -	RESTRICTED TO -	
CUSTOMER DRAWING			SCALE NTS	SHEET 2 OF 2

2308272