

THIS DRAWING IS UNPUBLISHED. RELEASED FOR PUBLICATION
 © COPYRIGHT - By - ALL RIGHTS RESERVED.

REVISIONS				
P	LTR	DESCRIPTION	DATE	APVD
E		REVISED PER ECO-18-001882	13FEB2018	AP DG

NOTE:

- MATERIAL:
 HOUSING: PBT WITH 20% GF UL 94 V-0, BLACK COLOR
 CONTACTS: PHOSPHOR BRONZE.
 SHELL: STEEL.
 SCREW: BRASS.
 SCREW LOCK: BRASS.
 SCREW TORQUE: 5kgf-cm MAX.
- FINISH:
 CONTACTS: GOLD PLATED ON CONTACT AREA,
 0.375µm [15µ"] MIN. MATTE TIN ON SOLDER TAIL
 2.54µm [100µ"], WITH ENTIRE CONTACT
 UNDERPLATED 1.27µm [50µ"] MIN. NICKEL.
 FRONT SHELL: 2.54µm [100µ"] MIN. NICKEL PLATED.
 REAR SHELL: 1.27µm [50µ"] MIN NICKEL UNDERPLATE.
 2.54µm [100µ"] MIN BRIGHT TIN PLATE
 SCREW LOCK: 1.27µm [50µ"] MIN. NICKEL PLATED.
 BOARDLOCK: 1.27µm [50µ"] MIN NICKEL UNDERPLATE.
 1.27µm [50µ"] MIN MATTE TIN PLATE
- WAVE SOLDER CAPABLE TO 265°C PER TE TEST SPEC. 109-202, CONDITION B.

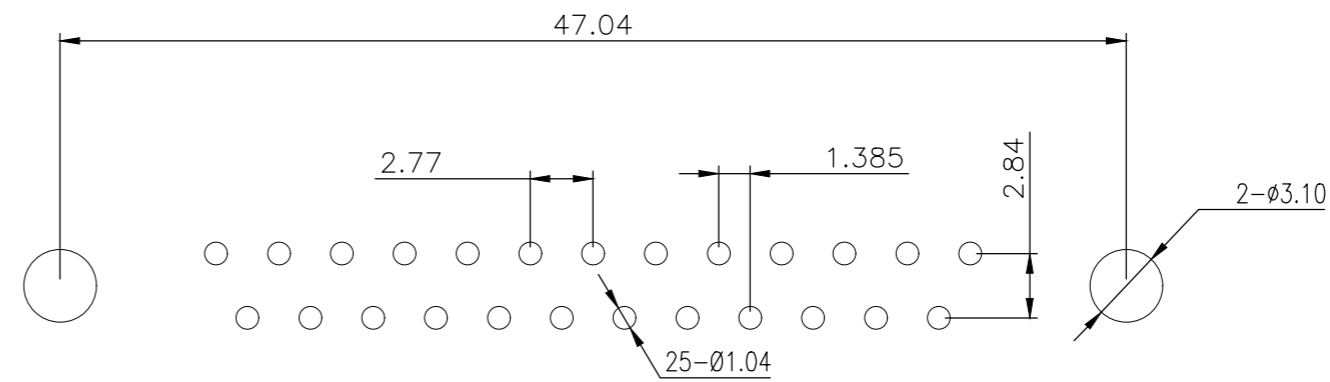
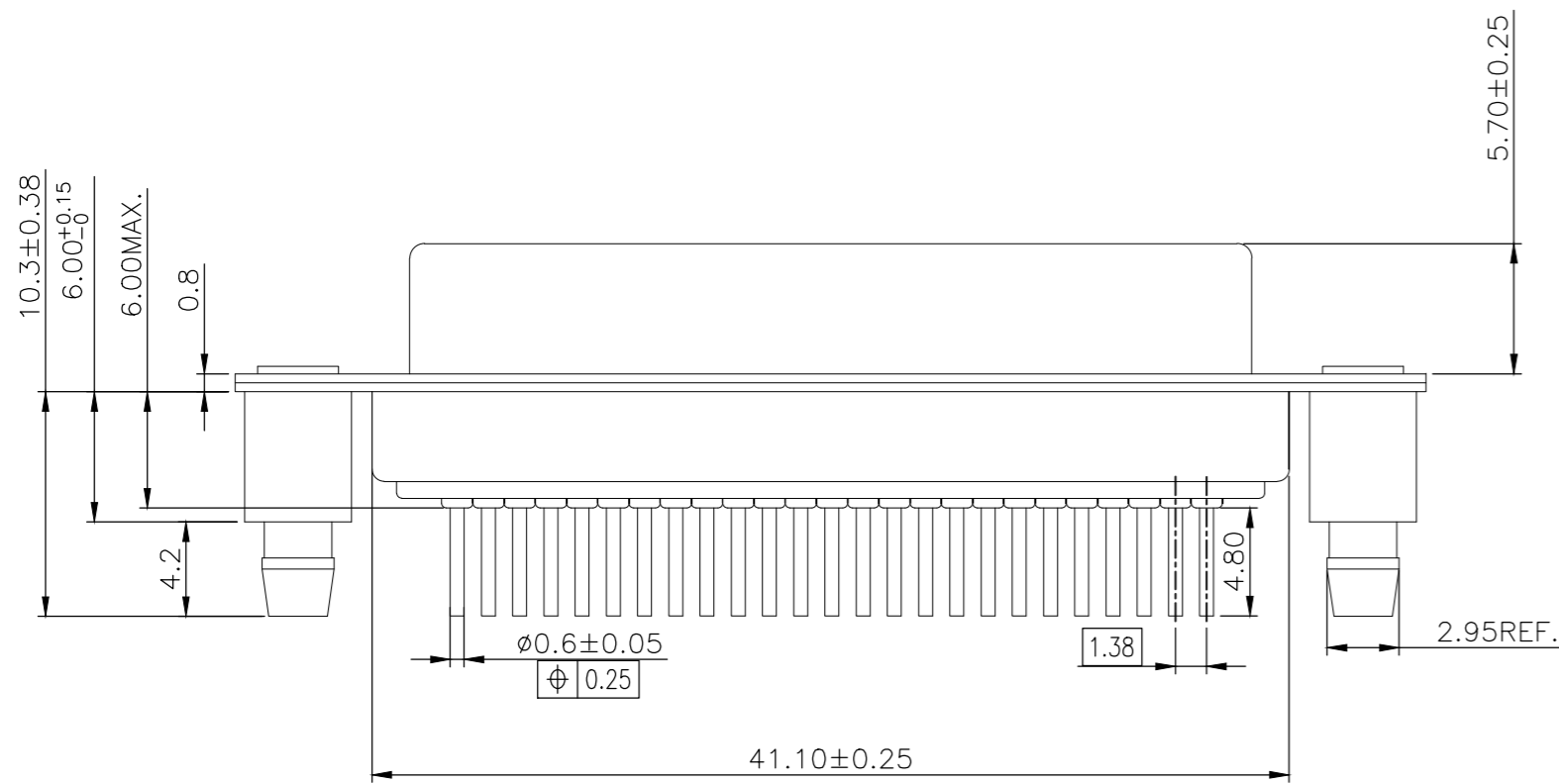
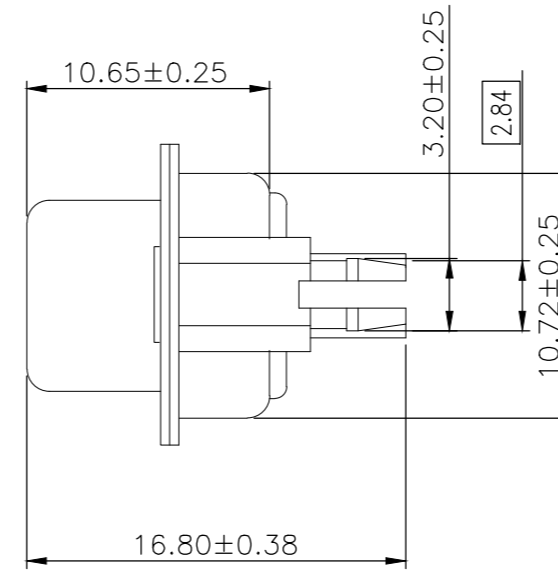
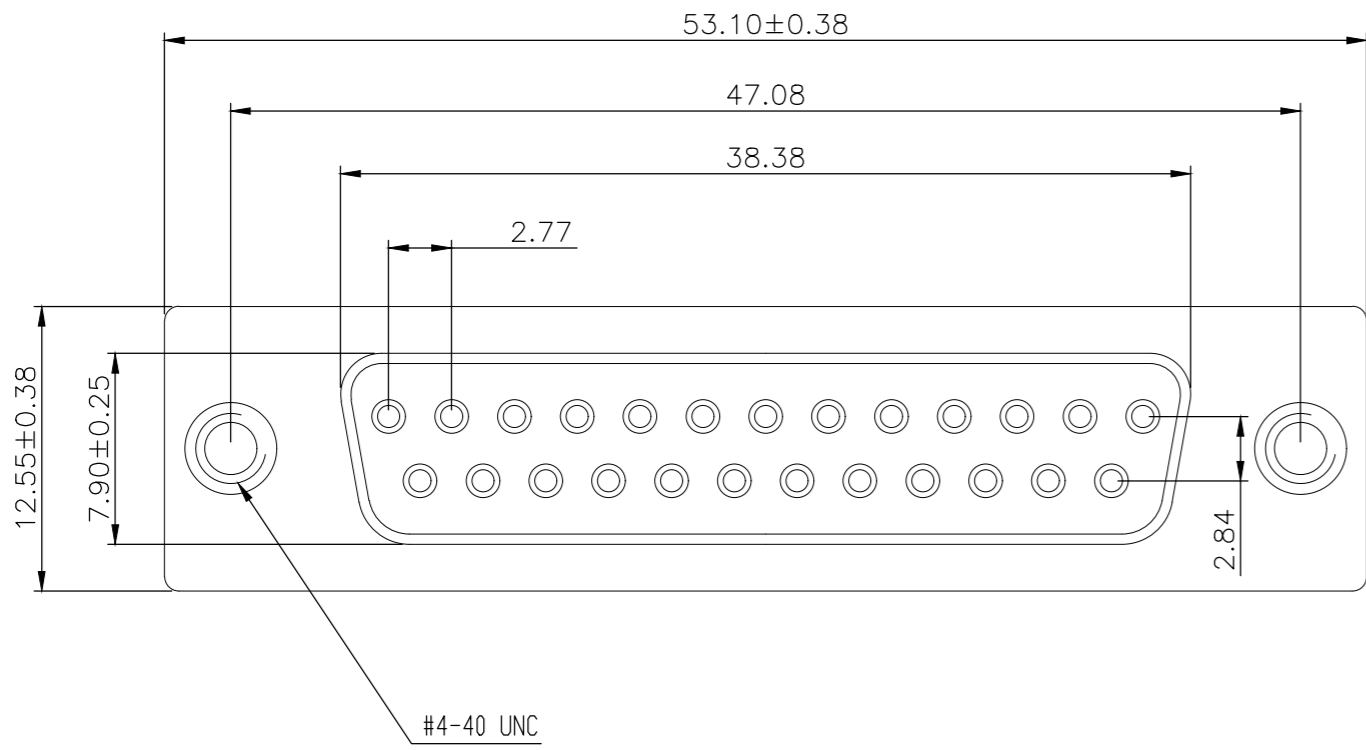

RECOMMENDED PCB LAYOUT

2301841

THIS DRAWING IS A CONTROLLED DOCUMENT.		DWN	AJITH PAI	07FEB2017
DIMENSIONS:		CHK	DAN GORENC	07FEB2017
mm	TOLERANCES UNLESS OTHERWISE SPECIFIED:	APVD	-	07FEB2017
	0 PLC	±	-	PRODUCT SPEC
	1 PLC	±	0.25	108-130013
	2 PLC	±	0.15	APPLICATION SPEC
	3 PLC	±	-	-
MATERIAL	FINISH	WEIGHT	0	CUSTOMER DRAWING
-	-	SCALE	3:1	SHEET 1 of 4

25w D skt W B/L & 4-40 inserts 15u" gold		2301841-1	
DESCRIPTION		TE PART NO	
TE TE Connectivity			
D-SUB VERTICAL 25P SKT CONNECTOR			
SIZE	CAGE CODE	DRAWING NO	RESTRICTED TO
A2	00779	C=2301841	-
SCALE		REV	
3:1		E	

THIS DRAWING IS UNPUBLISHED. RELEASED FOR PUBLICATION
 © COPYRIGHT - By - ALL RIGHTS RESERVED.

REVISIONS					
P	LTR	DESCRIPTION	DATE	DWN	APVD
-	-	SEE SHEET 1	-	-	-

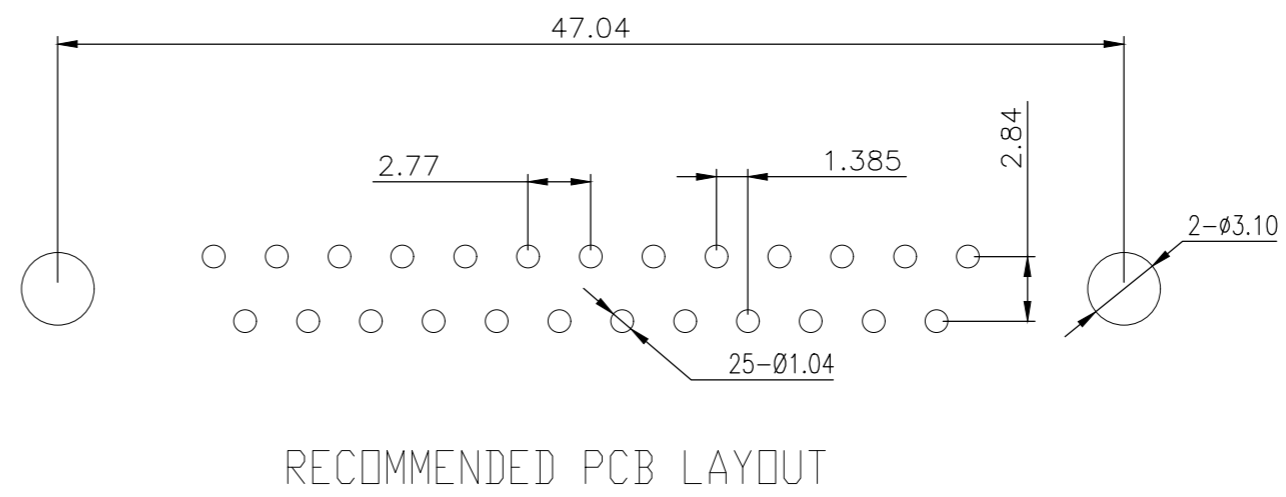
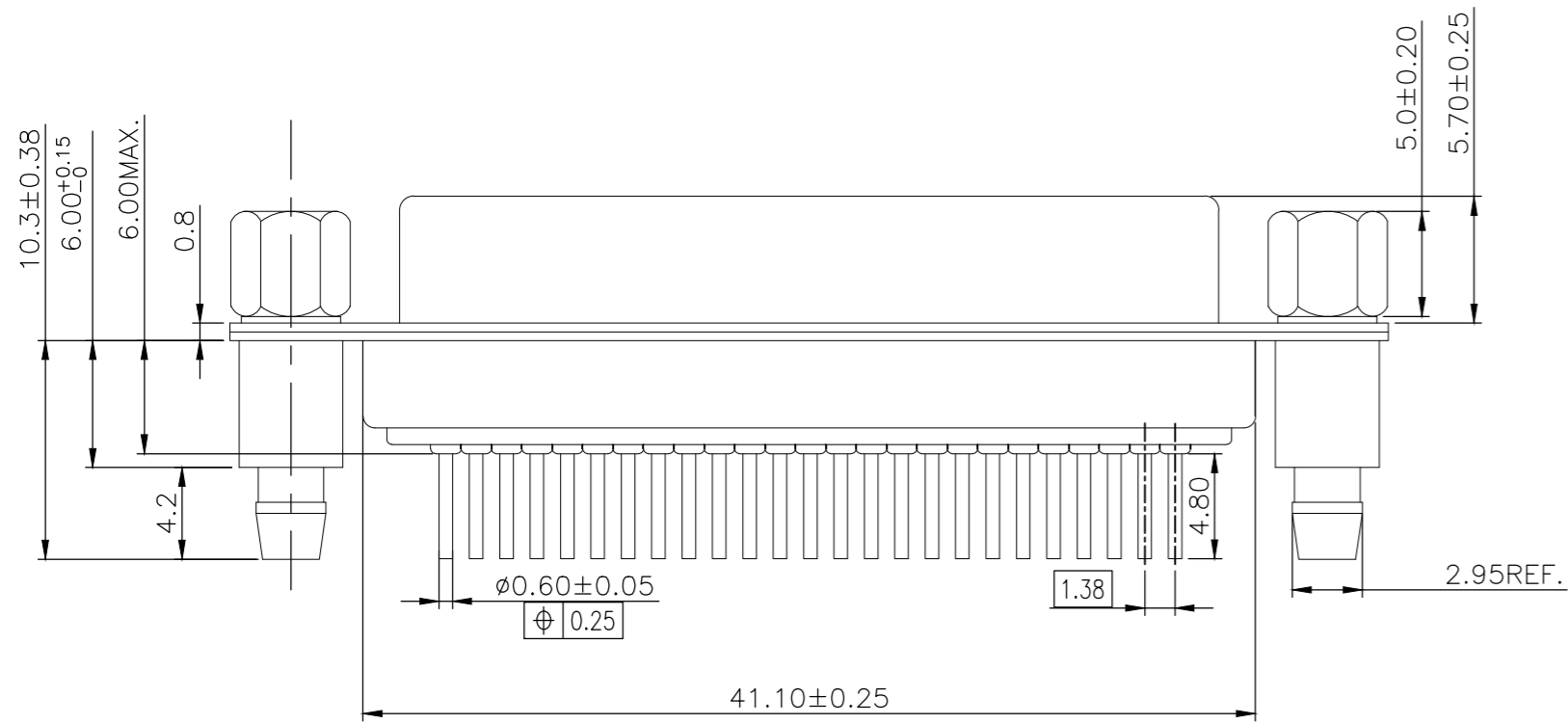
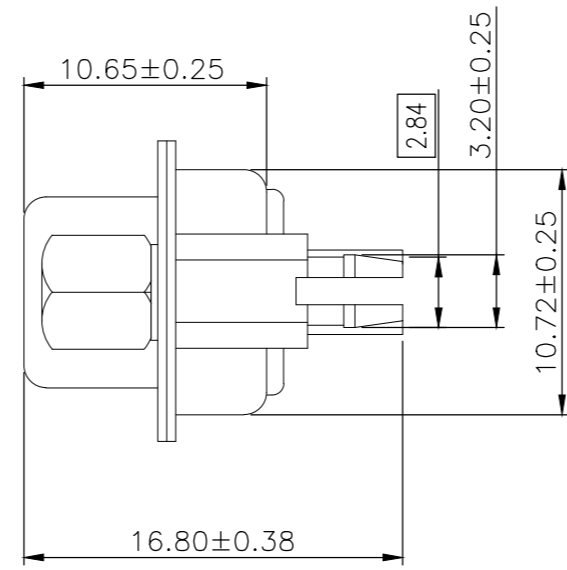
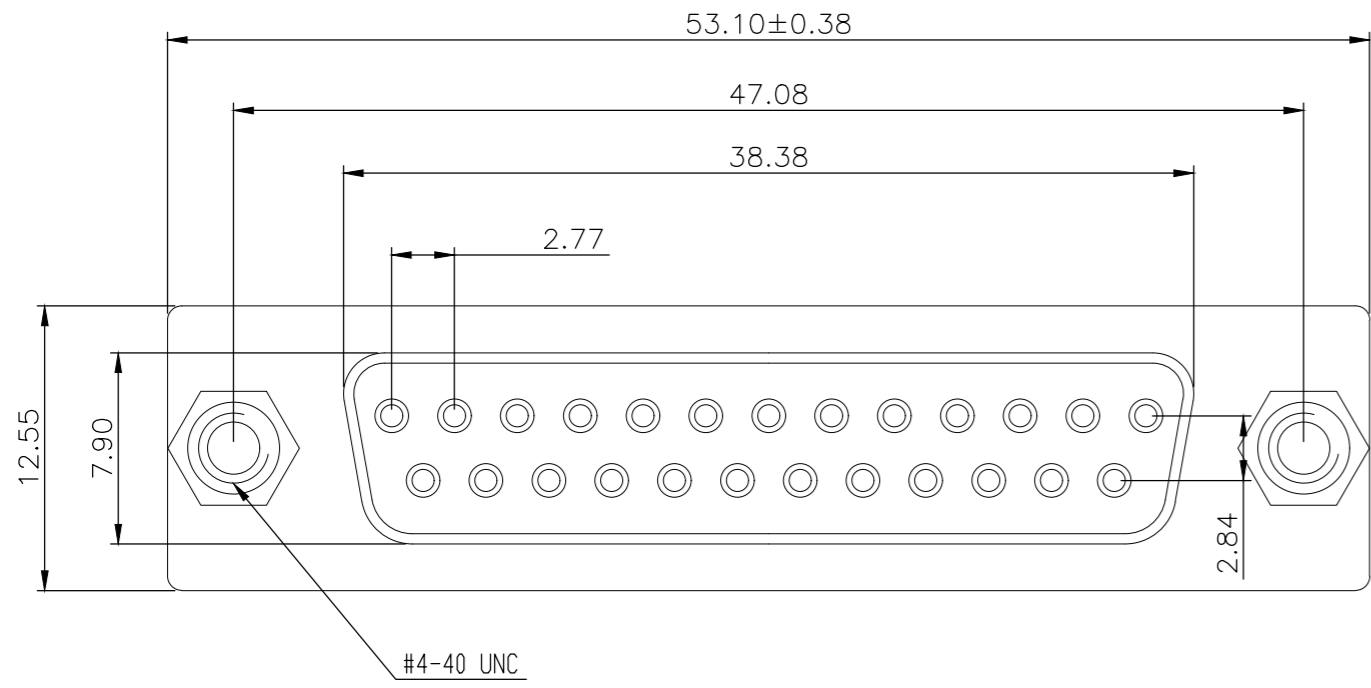

THIS DRAWING IS A CONTROLLED DOCUMENT.		DWN	AJITH PAI	07FEB2017
DIMENSIONS:		CHK	DAN GORENC	07FEB2017
mm	TOLERANCES UNLESS OTHERWISE SPECIFIED:	APVD	-	07FEB2017
	0 PLC	±	-	PRODUCT SPEC
	1 PLC	±	0.25	108-130013
	2 PLC	±	0.15	APPLICATION SPEC
	3 PLC	±	-	-
MATERIAL	FINISH	WEIGHT	0	CUSTOMER DRAWING
-	-	SCALE	3:1	SHEET 2 of 4
		REVISIONS	REV	E

25w D skt W B/L & 4-40 s/lock 15u" gold		2301841-2	
DESCRIPTION		TE PART NO	
TE TE Connectivity			
NAME			
D-SUB VERTICAL 25P SKT CONNECTOR			
SIZE	CAGE CODE	DRAWING NO	RESTRICTED TO
A2	00779	C=2301841	-
SCALE		SHEET	REV
3:1		2 of 4	E

THIS DRAWING IS UNPUBLISHED. RELEASED FOR PUBLICATION
 © COPYRIGHT - By - ALL RIGHTS RESERVED.

REVISIONS					
P	LTR	DESCRIPTION	DATE	DWN	APVD
-	-	SEE SHEET 1	-	-	-

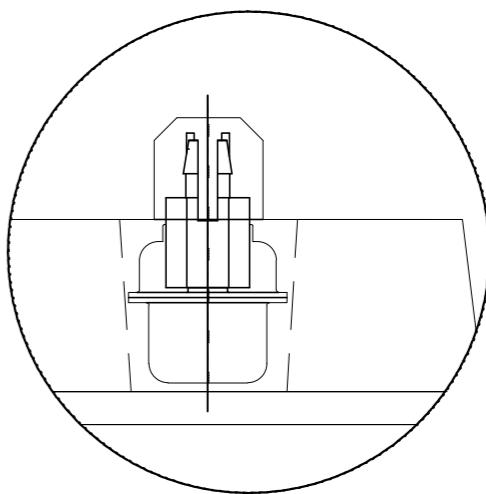
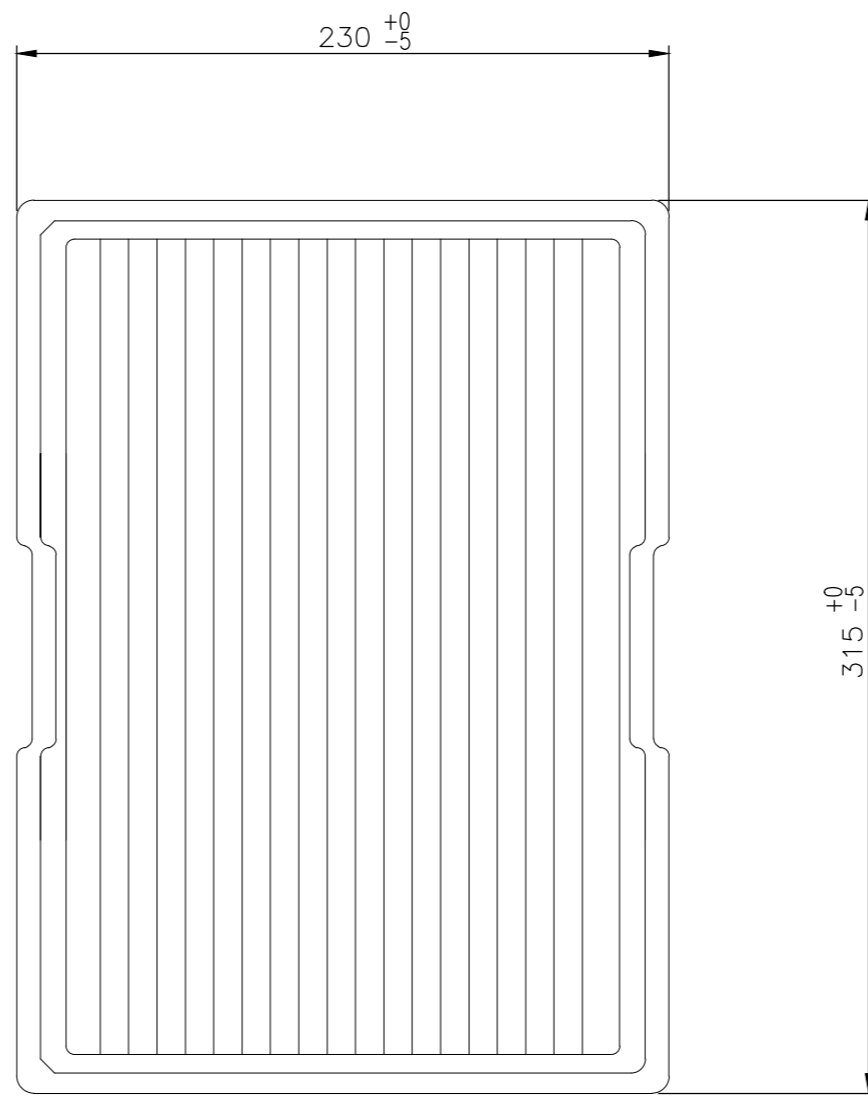
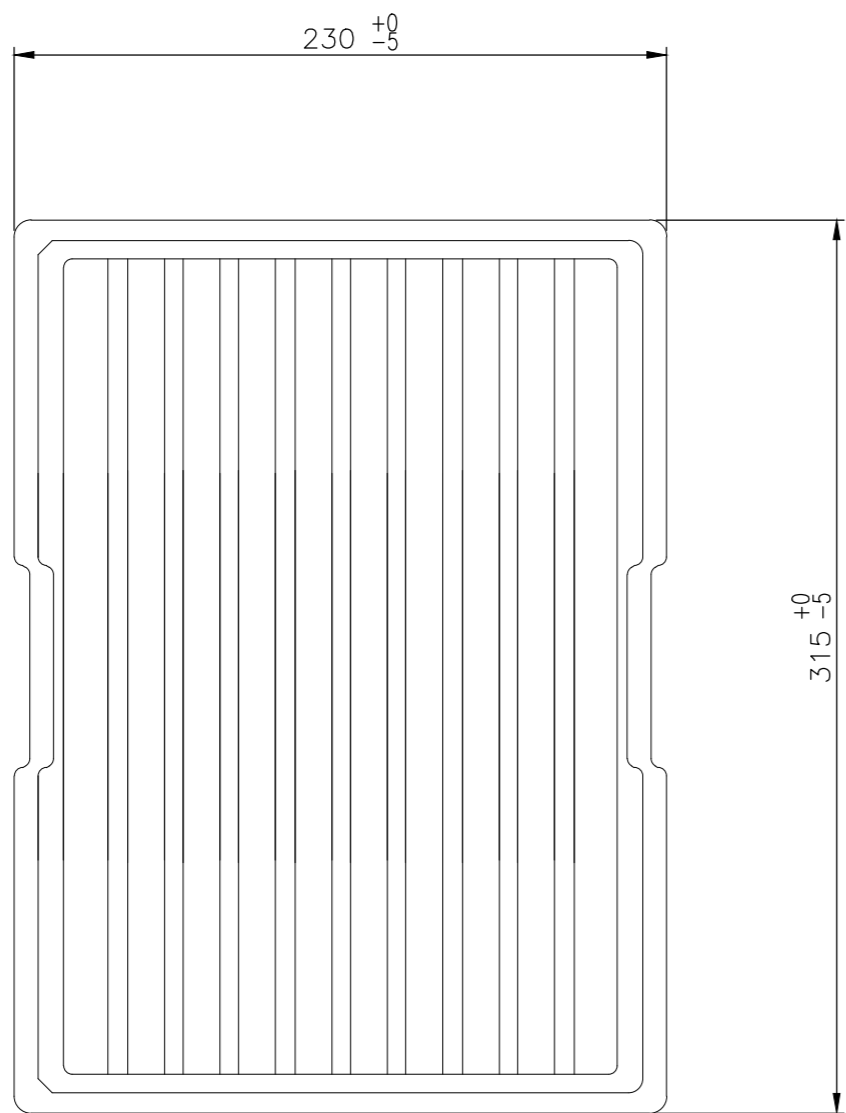
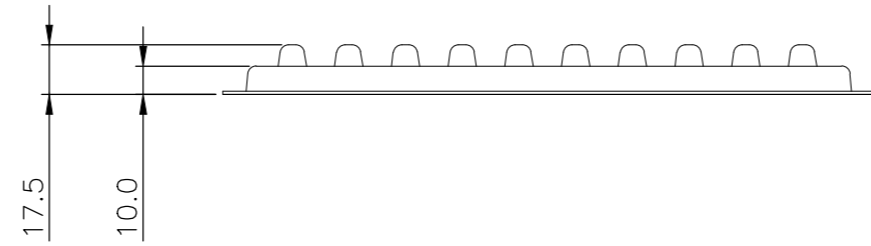
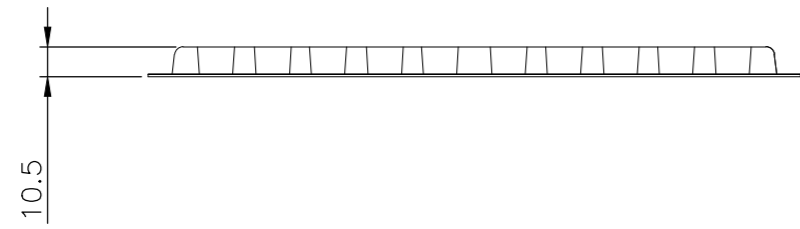

DETAIL A

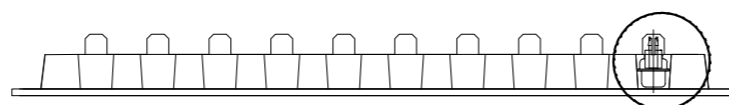

SEE DETAIL A

THIS DRAWING IS A CONTROLLED DOCUMENT.		DWN AJITH PAI 07FEB2017	STE TE Connectivity	
DIMENSIONS: mm		CHK DAN GORENC 07FEB2017		
TOLERANCES UNLESS OTHERWISE SPECIFIED:		APVD - 07FEB2017	NAME D-SUB VERTICAL 25P SKT CONNECTOR	
0 PLC ± -		PRODUCT SPEC 108-130013	SIZE A2	CAGE CODE 00779
1 PLC ± 0.25		APPLICATION SPEC -	DRAWING NO C=2301841	RESTRICTED TO -
2 PLC ± 0.15		WEIGHT 0	SCALE 1:1	SHEET 3 of 4
3 PLC ± -		CUSTOMER DRAWING	REV E	
4 PLC ± -				
ANGLES ± -				
FINISH -				

2301841

THIS DRAWING IS UNPUBLISHED. RELEASED FOR PUBLICATION
 © COPYRIGHT - By - ALL RIGHTS RESERVED.

REVISIONS					
P	LTR	DESCRIPTION	DATE	DWN	APVD
-	-	SEE SHEET 1	-	-	-

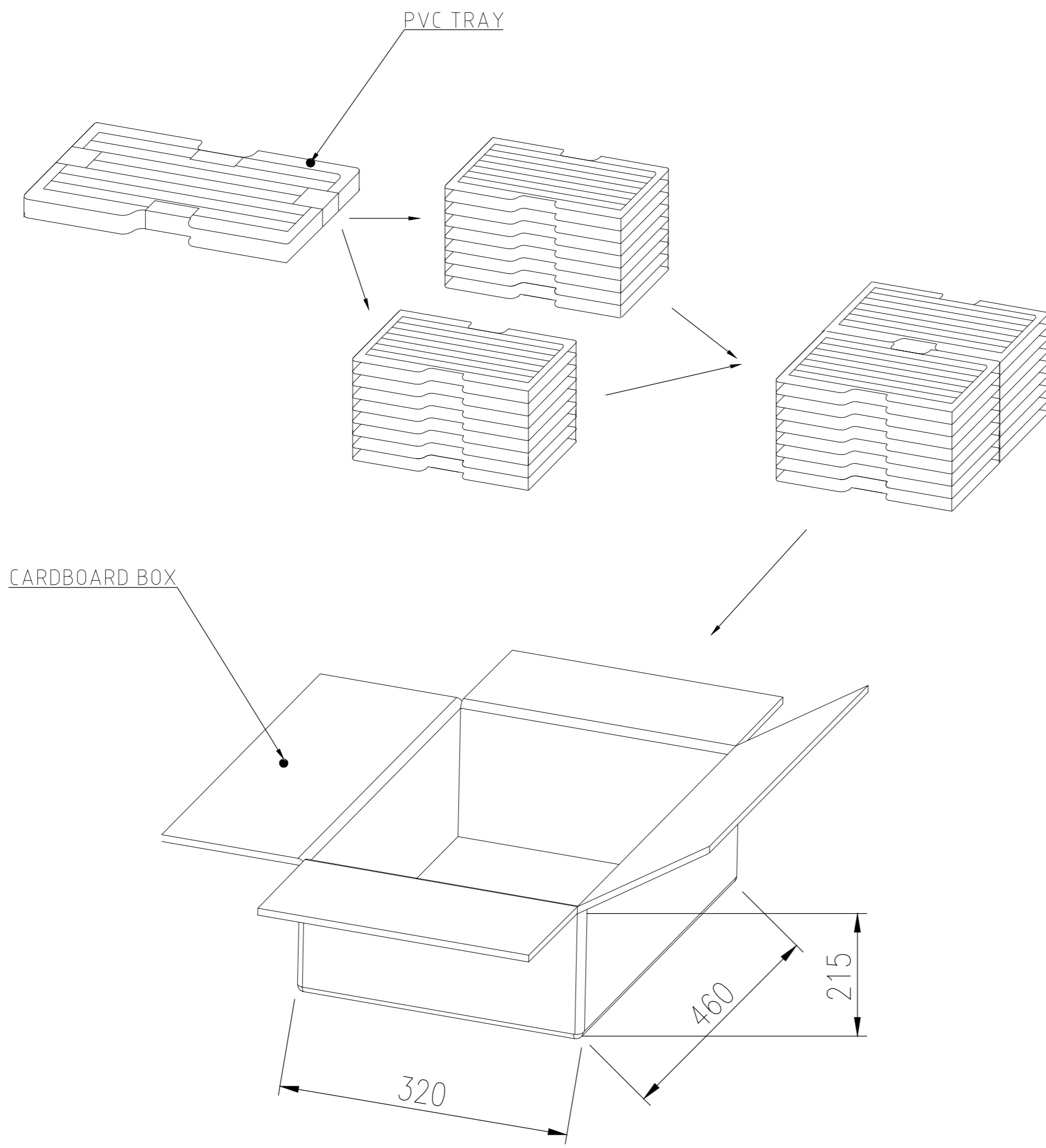

15.979	13.400	50	20	1000	2301841-2
14.479	11.900	50	20	1000	2301841-1
GROSS WEIGHT (Kg)	NET WEIGHT (Kg)	PCS/TRAY	TRAYS /CARTON	QUANTITY PCS	PART NUMBER

THIS DRAWING IS A CONTROLLED DOCUMENT.		DWN AJITH PAI 07FEB2017			
DIMENSIONS: mm		CHK DAN GORENC 07FEB2017			
TOLERANCES UNLESS OTHERWISE SPECIFIED:		APVD - 07FEB2017	NAME D-SUB VERTICAL 25P SKT CONNECTOR		
0 PLC ± -		PRODUCT SPEC 108-130013	SIZE A2		
1 PLC ± 0.25		APPLICATION SPEC -	CAGE CODE 00779	DRAWING NO C=2301841	RESTRICTED TO -
2 PLC ± 0.15		WEIGHT 0	SCALE 1:1		
3 PLC ± -		CUSTOMER DRAWING	SHEET 4 of 4	REV E	
4 PLC ± -					
ANGLES ± -					
FINISH -					

2301841