

**Contact Dimensions:**

**558-90 Degree Bend (Code 541 Contacts)**

See Sheet 2 for Contact Code 555, 556, 558, 559, 560 Dimensions

THIS IS A C.A.D. GENERATED DRAWING  
DO NOT MAKE MANUAL REVISIONS TO MASTER



ISSUE NUMBER

ORIGINAL

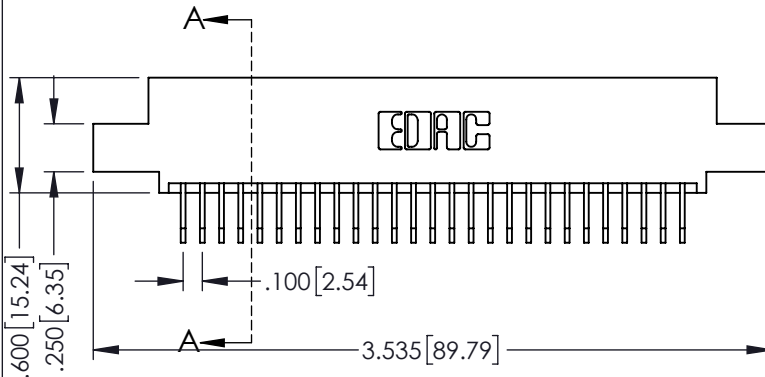
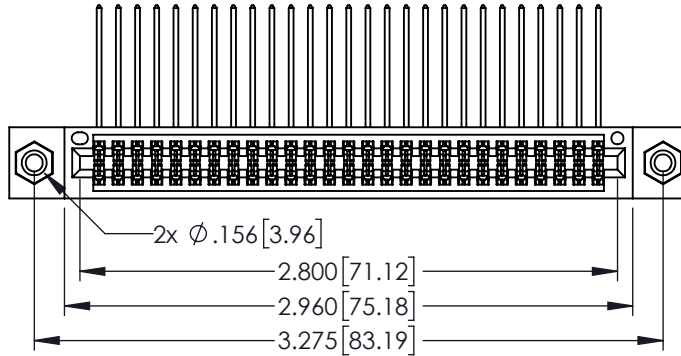

- INSULATOR MATERIAL: THERMOPLASTIC PBT BLACK, UL 94V-0
- CONTACT MATERIAL: COPPER TIN ALLOY
- CONTACT PLATING: GOLD ON THE MATING AREA, TIN PLATING ON THE CONTACT TAILS, NICKEL UNDERPLATE

**345/395 SERIES CARD EDGE CONNECTOR  
PART NUMBER: 345-054-558-508**



YOUR CONNECTION TO QUALITY & SERVICE

EDAC INC  
TORONTO, ONTARIO  
CANADA

THESE DRAWINGS AND SPECIFICATIONS ARE THE PROPERTY OF EDAC INC. AND SHALL NOT BE REPRODUCED, OR COPIED OR USED AS THE BASIS FOR THE MANUFACTURE OR SALE OF APPARATUS WITHOUT WRITTEN PERMISSION.

ACAD REFERENCE NO. 345-ENG-MASTER

DRAWN: R.STA.MONICA DATE: MAY.16/2017

CHECKED: DATE:

SCALE: 1:1 SHEET 1 OF 2

DRAWING NUMBER 345-ENG-MASTER ISSUE 1

**Contact Description:**  
**559-90 Degree Bend (Code 541 Contacts)**

THIS IS A C.A.D. GENERATED DRAWING  
 DO NOT MAKE MANUAL REVISIONS TO MASTER



ISSUE NUMBER

ORIGINAL



**Contact Code 555**



**Contact Code 556**



**Contact Code 558**



**Contact Code 559**



**Contact Code 560**

- INSULATOR MATERIAL: THERMOPLASTIC POLYESTER, UL 94V-0
- DAP MATERIAL AVAILABLE UPON REQUEST
- CONTACT MATERIAL: COPPER ALLOY
- CONTACT PLATING: GOLD ON THE MATING AREA, TIN PLATING ON THE CONTACT TAILS, NICKEL UNDERPLATE

**345/395 SERIES CARD EDGE CONNECTOR  
 CONTACT CODE 555,556,558,559,560 DIMENSIONS**



EDAC INC  
 TORONTO, ONTARIO  
 CANADA

YOUR CONNECTION TO QUALITY & SERVICE

THESE DRAWINGS AND SPECIFICATIONS  
 ARE THE PROPERTY OF EDAC INC. AND  
 SHALL NOT BE REPRODUCED, OR COPIED  
 OR USED AS THE BASIS FOR THE  
 MANUFACTURE OR SALE OF APPARATUS  
 WITHOUT WRITTEN PERMISSION.

ACAD REFERENCE NO. 345-ENG-MASTER

DRAWN: R.STA.MONICA DATE: MAY.16/2017

CHECKED: DATE:

SCALE: 1:1 SHEET 2 OF 2

DRAWING NUMBER 345-ENG-MASTER ISSUE 1