

SDURB1040 ULTRAFAST RECTIFIER

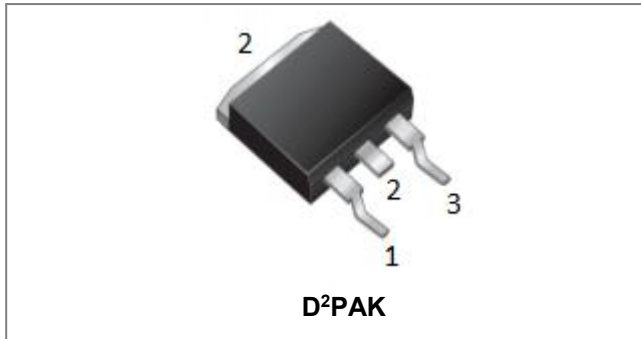

Applications

- Antiparallel diode for high frequency switching devices
- Anti saturation diode
- Snubber diode
- Free wheeling diode in converters and motor control circuits
- Rectifiers in switch mode power supplies (SMPS)
- Inductive heating and melting
- Uninterruptible power supplies (UPS)
- Ultrasonic cleaners and welders

Circuit Diagram

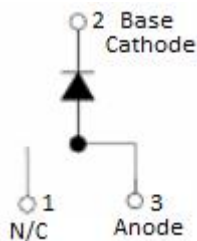

Features

- Ultra-Fast switching
- High current capability
- Low reverse leakage current
- High surge current capability
- “-A” is an AEC-Q101 qualified device
- This is a Pb – free device
- All SMC parts are traceable to the wafer lot
- Additional testing can be offered upon request

Maximum Ratings:

| Characteristics | Symbol | Condition | Max. | Units |
|--|---------------------------------|---|------|-------|
| Peak Repetitive Reverse Voltage Working Peak Reverse Voltage DC Blocking Voltage | V_{RRM} V_{RWM} V_R | - | 400 | V |
| Average Rectified Forward Current | $I_{F(AV)}$ | 50% duty cycle @ $T_c=105^\circ\text{C}$, rectangular wave form | 10 | A |
| Peak One Cycle Non-Repetitive Surge Current | I_{FSM} | 8.3ms, Half Sine pulse | 125 | A |

Electrical Characteristics:

| Characteristics | Symbol | Condition | Typ. | Max. | Units |
|-----------------------|----------|---|------|------|---------------|
| Forward Voltage Drop* | V_{F1} | @ 10A, Pulse, $T_J = 25^\circ\text{C}$ | 1.06 | 1.3 | V |
| | V_{F2} | @ 10A, Pulse, $T_J = 125^\circ\text{C}$ | 0.98 | 1.2 | V |
| Reverse Current* | I_{R1} | @ $V_R = \text{rated } V_R, T_J = 25^\circ\text{C}$ | 0.06 | 10 | μA |
| | I_{R2} | @ $V_R = \text{rated } V_R, T_J = 125^\circ\text{C}$ | 7 | 500 | μA |
| Reverse Recovery Time | t_{rr} | $I_F=500\text{mA}, I_R=1\text{A}, \text{ and } I_{tm}=250\text{mA}$ | 39 | 45 | ns |

* Pulse width < 300 μs , duty cycle < 2%

- China - Germany - Korea - Singapore - United States •
- <http://www.smc-diodes.com> - sales@smc-diodes.com •

Thermal-Mechanical Specifications:

| Characteristics | Symbol | Condition | Specification | Units |
|--|-----------------------|--------------|---------------|-----------------------------|
| Junction Temperature | T_J | - | -55 to +150 | $^{\circ}\text{C}$ |
| Storage Temperature | T_{stg} | - | -55 to +150 | $^{\circ}\text{C}$ |
| Typical Thermal Resistance Junction to Ambient | $R_{\theta\text{JA}}$ | DC operation | 5 | $^{\circ}\text{C}/\text{W}$ |
| Approximate Weight | wt | - | 1.85 | g |
| Case Style | D ² PAK | | | |

Ratings and Characteristics Curves

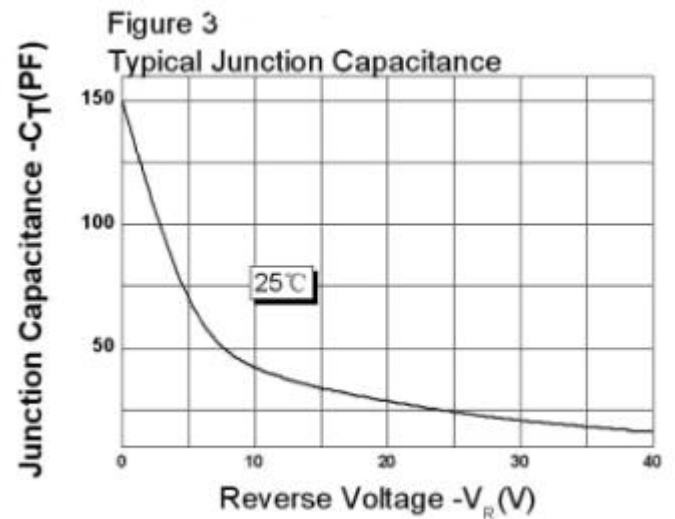
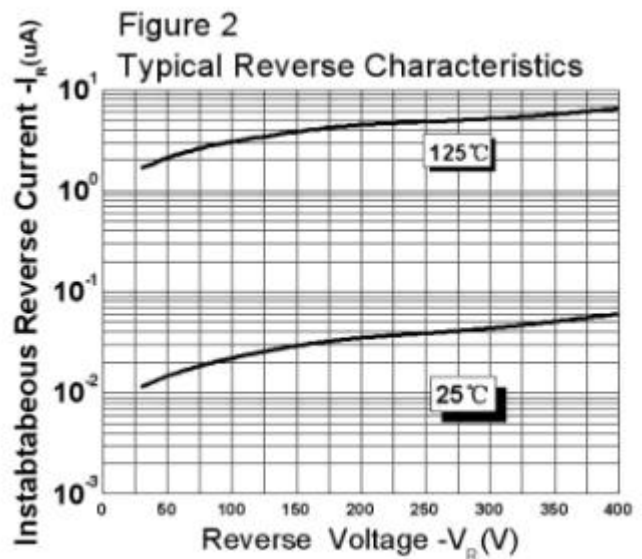
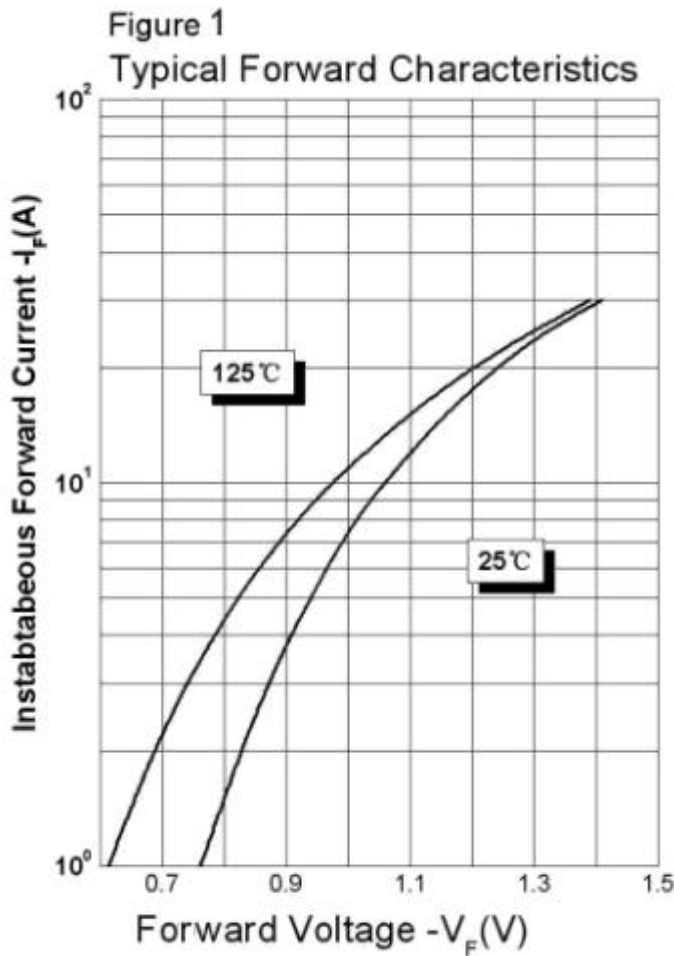

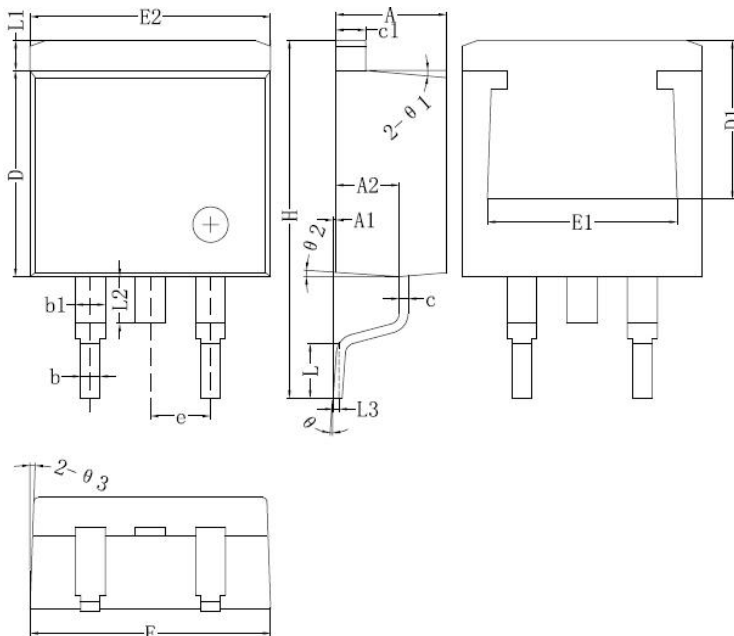
Mechanical Dimensions D²PAK

| Symbol | Dimensions in millimeters | | |
|--------|---------------------------|---------|-------|
| | Min. | Typical | Max. |
| A | 4.47 | 4.70 | 4.85 |
| A1 | 0 | 0.10 | 0.25 |
| A2 | 2.59 | 2.69 | 2.89 |
| b | 0.71 | 0.81 | 0.96 |
| b1 | 1.17 | 1.27 | 1.37 |
| c | 0.31 | 0.38 | 0.61 |
| c1 | 1.17 | 1.27 | 1.37 |
| D | 8.50 | 8.70 | 8.90 |
| D1 | 6.40 | | |
| E | 10.01 | 10.16 | 10.31 |
| E1 | 7.6 | | |
| E2 | 9.98 | 10.08 | 10.31 |
| e | | 2.54 | |
| H | 14.6 | 15.1 | 15.6 |
| L | 2.00 | 2.30 | 2.74 |
| L1 | 1.12 | 1.27 | 1.42 |
| L2 | 1.30 | | 2.20 |
| L3 | | 0.25BSC | |
| e | 0 | - | 8° |
| e1 | | 5° | |
| e2 | | 4° | |
| e3 | | 4° | |

Ordering Information

| Device | Package | Shipping |
|-------------|--------------------|---------------|
| SDURB1040 | D ² PAK | 800pcs / reel |
| SDURB1040TR | D ² PAK | 800pcs / reel |

For information on tape and reel specifications, including part orientation and tape sizes, please refer to our tape and reel packaging specification.

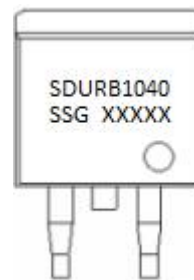
Marking Diagram

Where XXXXX is YYWWL

SDUR = Device Type
 B = Package type
 10 = Forward Current (10A)
 40 = Reverse Voltage(400V)
 SSG = SSG
 YY = Year
 WW = Week
 L = Lot Number

Cautions: Molding resin
 Epoxy resin UL:94V-0

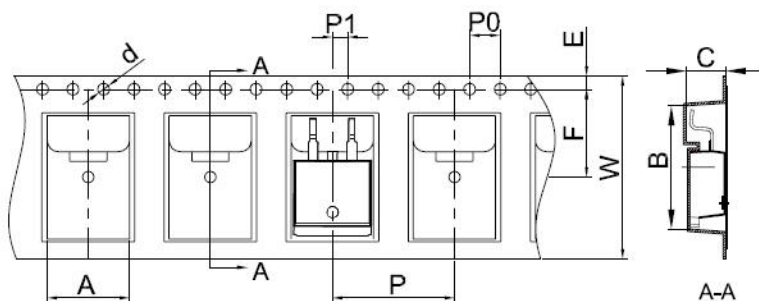
Carrier Tape Specification D²PAK

| SYMBOL | Millimeters | |
|--------|-------------|-------|
| | Min. | Max. |
| A | 10.70 | 10.90 |
| B | 16.03 | 16.23 |
| C | 5.11 | 5.31 |
| d | 1.45 | 1.65 |
| E | 1.65 | 1.85 |
| F | 11.40 | 11.60 |
| P0 | 3.90 | 4.10 |
| P | 15.90 | 16.10 |
| P1 | 1.90 | 2.10 |
| W | 23.90 | 24.30 |

DISCLAIMER:

1- The information given herein, including the specifications and dimensions, is subject to change without prior notice to improve product characteristics. Before ordering, purchasers are advised to contact the SMC Diode Solutions sales department for the latest version of the datasheet(s).

2- In cases where extremely high reliability is required (such as use in nuclear power control, aerospace and aviation, traffic equipment, medical equipment, and safety equipment), safety should be ensured by using semiconductor devices that feature assured safety or by means of users' fail-safe precautions or other arrangement.

3- In no event shall SMC Diode Solutions be liable for any damages that may result from an accident or any other cause during operation of the user's units according to the datasheet(s). SMC Diode Solution assumes no responsibility for any intellectual property claims or any other problems that may result from applications of information, products or circuits described in the datasheets.

4- In no event shall SMC Diode Solutions be liable for any failure in a semiconductor device or any secondary damage resulting from use at a value exceeding the absolute maximum rating.

5- No license is granted by the datasheet(s) under any patents or other rights of any third party or SMC Diode Solutions.

6- The datasheet(s) may not be reproduced or duplicated, in any form, in whole or part, without the expressed written permission of SMC Diode Solutions.

7- The products (technologies) described in the datasheet(s) are not to be provided to any party whose purpose in their application will hinder maintenance of international peace and safety nor are they to be applied to that purpose by their direct purchasers or any third party. When exporting these products (technologies), the necessary procedures are to be taken in accordance with related laws and regulations..