

# Connector - SACC-MINFS-5CON-PG11/2,5 - 1456271

Please be informed that the data shown in this PDF Document is generated from our Online Catalog. Please find the complete data in the user's documentation. Our General Terms of Use for Downloads are valid (<http://phoenixcontact.com/download>)



Connector, Universal, 5-position, Socket straight 7/8"-UNF, A-coded, Screw connection, knurl material: Zinc die-cast, nickel-plated, cable gland Pg11, external cable diameter 8 mm ... 10 mm

## Your advantages

- ✓ Safe use in the field, thanks to a high degree of protection
- ✓ Flexible: connectors for on-site assembly
- ✓ Screw connection: proven connection technology for a large selection of different conductors



## Key Commercial Data

Packing unit	1 pc
GTIN	 4 046356 616904
GTIN	4046356616904

## Technical data

### Dimensions

Diameter housing	27 mm
Length	83 mm
External cable diameter	8 mm ... 10 mm
Stripping length of the sheath	30 mm
Stripping length of the individual wire	7 mm

### Ambient conditions

Ambient temperature (operation)	-25 °C ... 85 °C (Plug / socket)
Degree of protection	IP67

### General

Note	NOTE: Observe the permissible bending radii when laying conductors, since the degree of protection may be put in jeopardy if the bending forces are too high. Alleviate mechanical loads upstream of the connector, e.g. by using cable ties.
------	-----------------------------------------------------------------------------------------------------------------------------------------------------------------------------------------------------------------------------------------------

# Connector - SACC-MINFS-5CON-PG11/2,5 - 1456271

## Technical data

### General

Rated current at 40°C	9 A
Rated voltage	300 V AC
	300 V DC
Number of positions	5
Color handle area	black
Insulation resistance	≥ 100 MΩ
Coding	A - standard
Signal type/category	Universal
Status display	No
Overvoltage category	III
Degree of pollution	3
Connection method	Screw connection
Conductor cross section	0.34 mm <sup>2</sup> ... 2.5 mm <sup>2</sup> (without ferrule)
	0.34 mm <sup>2</sup> ... 2.5 mm <sup>2</sup> (with ferrule)
	0.34 mm <sup>2</sup> ... 2.5 mm <sup>2</sup> (solid)
Conductor cross section AWG	22 ... 16 (without ferrule)
	22 ... 16 (with ferrule)
Insertion/withdrawal cycles	≥ 100
Torque	0.8 Nm (7/8" connectors)
	0.4 Nm (Screw terminal blocks)
	1 Nm ... 1.4 Nm (Pressure nut)
Tightening torque	Screw plug insert with sleeve housing as far it will go
Assembly instructions	The wires can be connected both with ferrules and without ferrules

### Material

Flammability rating according to UL 94	HB
Contact material	CuZn
Contact surface material	Au
Contact carrier material	PUR / PA 6.6
Material of grip body	PBT
Material, knurls	Zinc die-cast, nickel-plated

### Standards and Regulations

Connection in acc. with standard	CUL
Flammability rating according to UL 94	HB

### Environmental Product Compliance

REACH SVHC	Lead 7439-92-1
China RoHS	Environmentally Friendly Use Period = 50
	For details about hazardous substances go to tab "Downloads", Category "Manufacturer's declaration"

## Drawings

# Connector - SACC-MINFS-5CON-PG11/2,5 - 1456271

Functional drawing

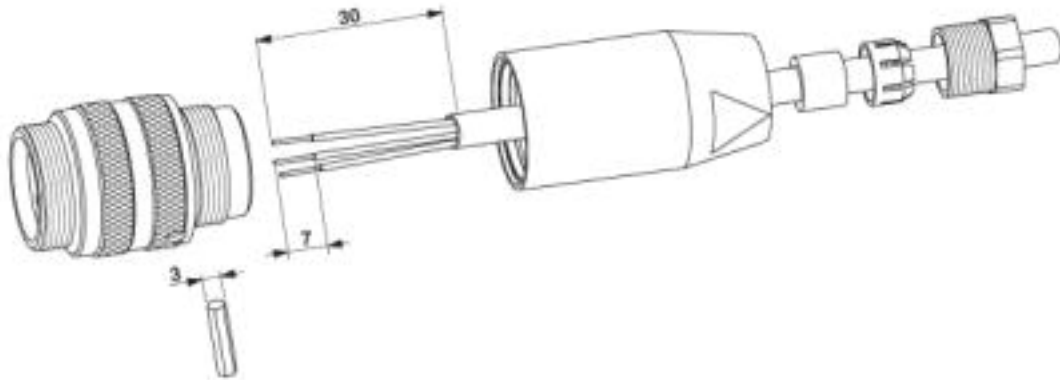

Dimensional drawing

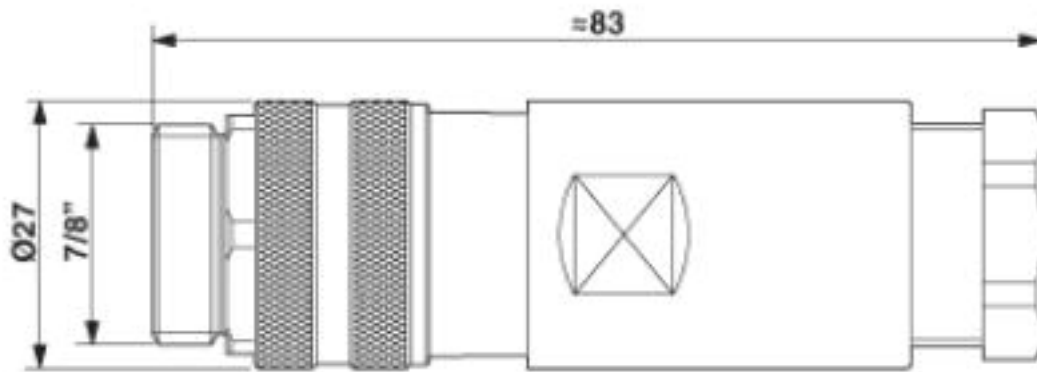

# Connector - SACC-MINFS-5CON-PG11/2,5 - 1456271

Schematic diagram

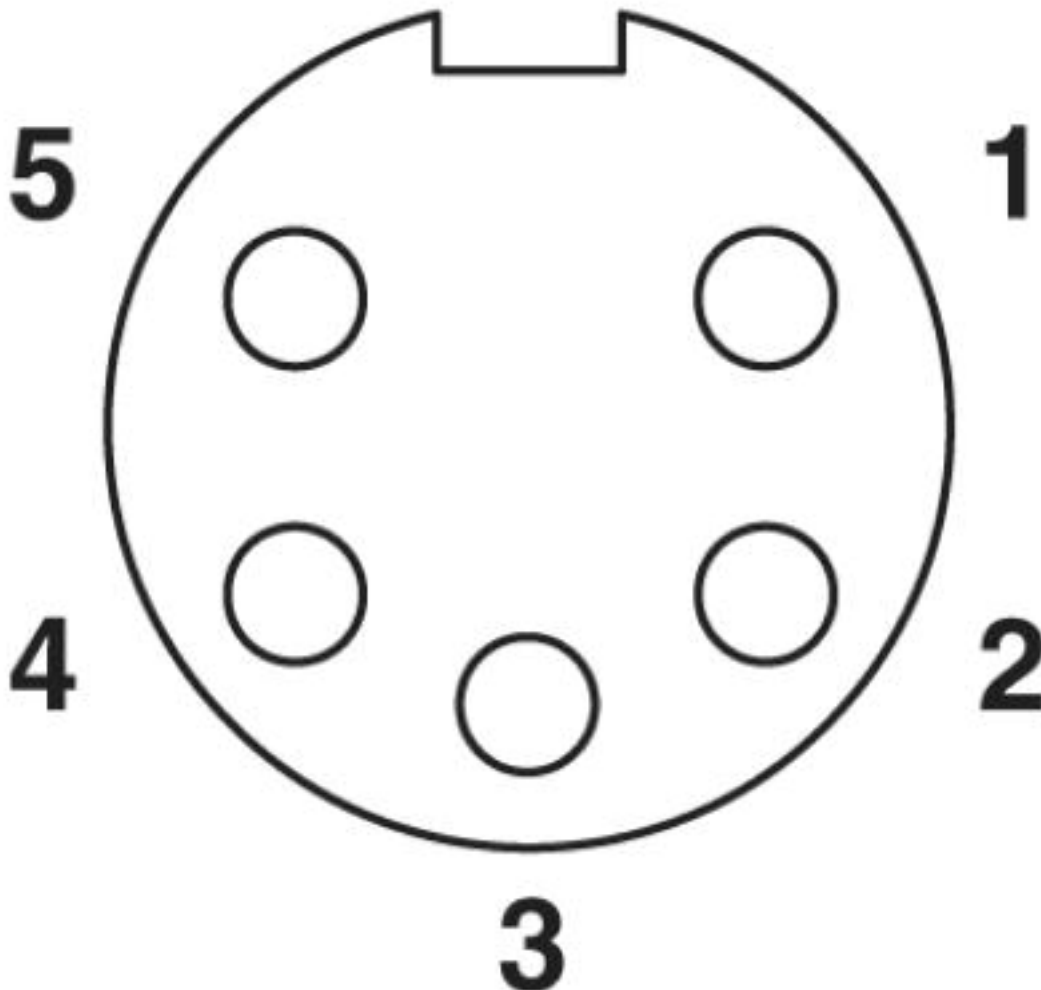

Pin assignment, socket, 7/8"-16UNF, 5-pos., view of female side

## Approvals

Approvals

---

Approvals

UL Recognized / cUL Recognized / EAC / cULus Recognized

---

Ex Approvals

---

## Approval details

# Connector - SACC-MINFS-5CON-PG11/2,5 - 1456271

## Approvals

UL Recognized		<a href="http://database.ul.com/cgi-bin/XYV/template/LISEXT/1FRAME/index.htm">http://database.ul.com/cgi-bin/XYV/template/LISEXT/1FRAME/index.htm</a>	FILE E 221474
Nominal voltage UN		600 V	
Nominal current IN		16 A	

cUL Recognized		<a href="http://database.ul.com/cgi-bin/XYV/template/LISEXT/1FRAME/index.htm">http://database.ul.com/cgi-bin/XYV/template/LISEXT/1FRAME/index.htm</a>	FILE E 221474
Nominal voltage UN		600 V	
Nominal current IN		16 A	

EAC		RU C- DE.AI30.B.01102
-----	------------------------------------------------------------------------------------	--------------------------

cULus Recognized	
------------------	-------------------------------------------------------------------------------------

Phoenix Contact 2019 © - all rights reserved  
<http://www.phoenixcontact.com>

PHOENIX CONTACT GmbH & Co. KG  
Flachsmarktstr. 8  
32825 Blomberg  
Germany  
Tel. +49 5235 300  
Fax +49 5235 3 41200  
<http://www.phoenixcontact.com>