



# IQ10-03BPSKT0S

IQB

INDUCTIVE PROXIMITY SENSORS

**SICK**  
Sensor Intelligence.



### Ordering information

Type	Part no.
IQ10-03BPSKT0S	1055453

Other models and accessories → [www.sick.com/IQB](http://www.sick.com/IQB)



### Detailed technical data

#### Features

<b>Housing</b>	Rectangular
<b>Dimensions (W x H x D)</b>	10 mm x 28 mm x 16 mm
<b>Sensing range <math>S_n</math></b>	3 mm
<b>Safe sensing range <math>S_a</math></b>	2.43 mm
<b>Installation type</b>	Flush
<b>Switching frequency</b>	2,000 Hz
<b>Connection type</b>	Connector M8, 3-pin
<b>Switching output</b>	PNP
<b>Output function</b>	NO
<b>Electrical wiring</b>	DC 3-wire
<b>Enclosure rating</b>	IP68 <sup>1)</sup>

<sup>1)</sup> According to EN 60529.

#### Mechanics/electronics

<b>Supply voltage</b>	10 V DC ... 30 V DC
<b>Ripple</b>	≤ 10 % <sup>1)</sup>
<b>Voltage drop</b>	≤ 2 V <sup>2)</sup>
<b>Current consumption</b>	10 mA <sup>3)</sup>
<b>Time delay before availability</b>	≤ 100 ms
<b>Hysteresis</b>	5 % ... 15 %
<b>Reproducibility</b>	≤ 2 % <sup>4)</sup>
<b>Temperature drift (of <math>S_n</math>)</b>	± 10 %

<sup>1)</sup> Of  $V_S$ .

<sup>2)</sup> At  $I_a$  max.

<sup>3)</sup> Without load.

<sup>4)</sup>  $U_b$  and  $T_a$  constant.

<b>EMC</b>	According to EN 60947-5-2
<b>Continuous current I<sub>a</sub></b>	≤ 200 mA
<b>Short-circuit protection</b>	✓
<b>Reverse polarity protection</b>	✓
<b>Power-up pulse protection</b>	✓
<b>Shock and vibration resistance</b>	30 g, 11 ms / 10 ... 55 Hz, 1 mm
<b>Ambient operating temperature</b>	-25 °C ... +75 °C
<b>Housing material</b>	Plastic, VISTAL®
<b>Sensing face material</b>	Plastic, VISTAL®
<b>Tightening torque, max.</b>	≤ 1 Nm
<b>MTTF<sub>d</sub>: mean time to dangerous failure</b>	1,775 years

1) Of V<sub>S</sub>.

2) At I<sub>a</sub> max.

3) Without load.

4) U<sub>b</sub> and T<sub>a</sub> constant.

### Safety-related parameters

<b>MTTF<sub>D</sub></b>	1,775 years
<b>DC<sub>avg</sub></b>	0%

### Reduction factors

<b>Note</b>	The values are reference values which may vary
<b>Stainless steel (V2A, 304)</b>	0.7
<b>Aluminum (Al)</b>	0.4
<b>Copper (Cu)</b>	0.3
<b>Brass (Br)</b>	0.5

### Installation note

<b>Remark</b>	Associated graphic see "Installation"
<b>A</b>	0 mm
<b>B</b>	10 mm
<b>C</b>	10.3 mm
<b>D</b>	9 mm
<b>E</b>	0 mm
<b>F</b>	24 mm
<b>G</b>	0 mm

### Classifications

<b>ECl@ss 5.0</b>	27270101
<b>ECl@ss 5.1.4</b>	27270101
<b>ECl@ss 6.0</b>	27270101
<b>ECl@ss 6.2</b>	27270101
<b>ECl@ss 7.0</b>	27270101
<b>ECl@ss 8.0</b>	27270101
<b>ECl@ss 8.1</b>	27270101

<b>ECl@ss 9.0</b>	27270101
<b>ETIM 5.0</b>	EC002714
<b>ETIM 6.0</b>	EC002714
<b>UNSPSC 16.0901</b>	39122230

## Installation note

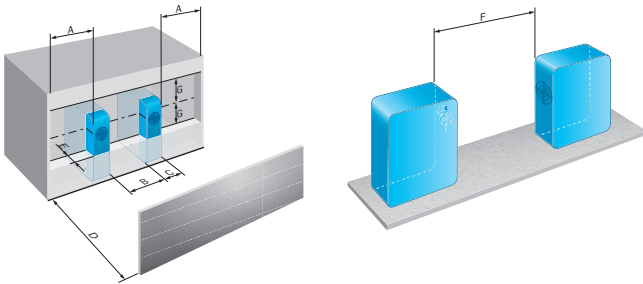

## Connection diagram

Cd-002

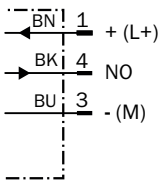

## Dimensional drawing (Dimensions in mm (inch))



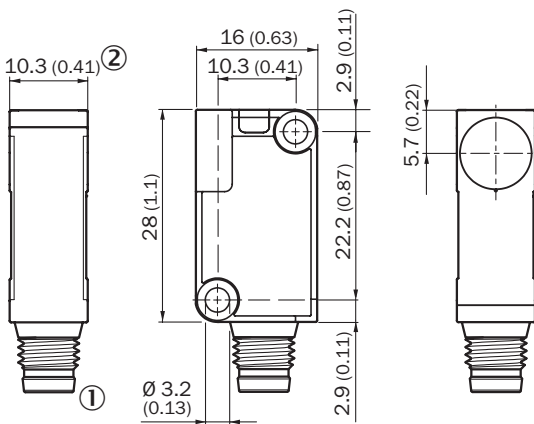

IQ10, connector



- ① Connection
- ② LED indicator 270°

## Recommended accessories

Other models and accessories → [www.sick.com/IQB](http://www.sick.com/IQB)

	Brief description	Type	Part no.
<b>Plug connectors and cables</b>			
	Head A: female connector, M8, 3-pin, straight, A-coded Head B: Flying leads Cable: Sensor/actuator cable, PVC, unshielded, 2 m	YF8U13-020VA1XLEAX	2095860
	Head A: female connector, M8, 3-pin, straight, A-coded Head B: Flying leads Cable: Sensor/actuator cable, PVC, unshielded, 5 m	YF8U13-050VA1XLEAX	2095884
	Head A: female connector, M8, 3-pin, angled, A-coded Head B: Flying leads Cable: Sensor/actuator cable, PVC, unshielded, 2 m	YG8U13-020VA1XLEAX	2096165
	Head A: female connector, M8, 3-pin, angled, A-coded Head B: Flying leads Cable: Sensor/actuator cable, PVC, unshielded, 5 m	YG8U13-050VA1XLEAX	2096166
	Head A: female connector, M8, 3-pin, straight Head B: - Cable: unshielded	DOS-0803-G	7902077
	Head A: female connector, M8, 3-pin, angled Head B: - Cable: unshielded	DOS-0803-W	7902078

## SICK AT A GLANCE

SICK is one of the leading manufacturers of intelligent sensors and sensor solutions for industrial applications. A unique range of products and services creates the perfect basis for controlling processes securely and efficiently, protecting individuals from accidents and preventing damage to the environment.

We have extensive experience in a wide range of industries and understand their processes and requirements. With intelligent sensors, we can deliver exactly what our customers need. In application centers in Europe, Asia and North America, system solutions are tested and optimized in accordance with customer specifications. All this makes us a reliable supplier and development partner.

Comprehensive services complete our offering: SICK LifeTime Services provide support throughout the machine life cycle and ensure safety and productivity.

For us, that is “Sensor Intelligence.”

## WORLDWIDE PRESENCE:

Contacts and other locations –[www.sick.com](http://www.sick.com)