

Process Sealed Miniature Toggle

Specifications

Electrical Ratings	5A @ 120VAC, 28VDC 2A @ 250VAC See Contact Options	Dielectric Resistance	1500Vrms min
Electrical Life	30,000 cycles typical	Insulation Resistance	>100MΩ min
Contact Resistance	<20mΩ initial @ 2-4VDC, 100mA	Operating Temperature	-40°C to 85°C
		Storage Temperature	-40°C to 85°C
		Sealing Degree	IP67

Materials

Actuator	Brass, Chrome Plated
Housing	4/6 Nylon, Glass Filled, Flame Retardant Heat Stabilized, UL94V-0
Support Bracket	Steel, Tin Plated
Contacts	Copper Alloy, Silver Plated
Terminals	Copper Alloy, Silver Plated

Ordering Information

1. Series	AST	1	1	T	N	H	Q
AST							
2. Number of Poles 1 = SPDT 2 = DPDT 3 = 3PDT							
3. Switch Function 1 = ON-NONE-ON 2 = ON-NONE-(ON) 3 = ON-OFF-ON 4 = (ON)-OFF-(ON) 5 = ON-OFF-(ON) 6 = ON-ON-ON - Only in DPDT models							
4. Actuator T = 7.62mm, standard S = 12.70mm, standard P1 = 7.62mm, plastic, anti-static P2 = 12.70mm, plastic, anti-static							
5. Bushing E = 8.89mm, threaded, 1/4-40 UNS-2A N = 6.10mm, non-threaded							
6. Terminals B = Solder lug C = PC pin D = Quick Connect H = Horizontal mount, right angle PC pin; HS = Snap-in V = Vertical mount, right angle PC pin S20 = PC pin with support bracket; V20 = Snap-in support bracket S25 = PC pin with support bracket; V25 = Snap-in support bracket							
7. Contacts Q = Silver plated R = Gold plated G = Gold over Silver plated							

Switch Function



SPDT



Function	Toggle Position		
1	ON	NONE	ON
2	ON	NONE	(ON)
3	ON	OFF	ON
4	(ON)	OFF	(ON)
5	ON	OFF	(ON)
Terminals	2-3	-	2-1

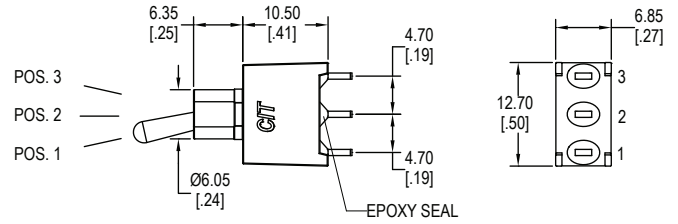
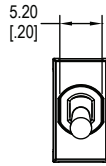

DPDT

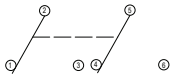

Function	Toggle Position		
1	ON	NONE	ON
2	ON	NONE	(ON)
3	ON	OFF	ON
4	(ON)	OFF	(ON)
5	ON	OFF	(ON)
Terminals	2-3	-	2-1
6	ON	ON	ON
Terminals	2-3 5-6	2-3 5-4	2-1 5-4

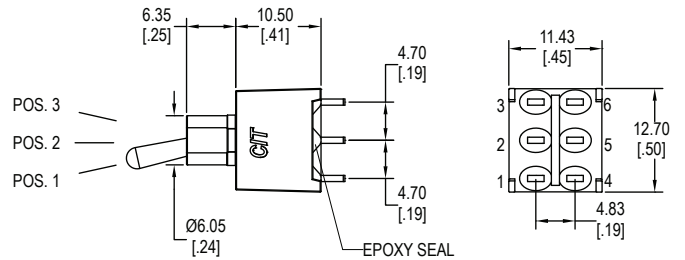
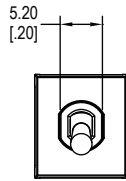

3PDT

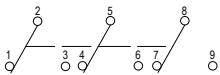

Function	Toggle Position		
1	ON	NONE	ON
2	ON	NONE	(ON)
3	ON	OFF	ON
4	(ON)	OFF	(ON)
5	ON	OFF	(ON)
Terminals	2-3 5-6 8-9	-	2-1 5-4 8-7

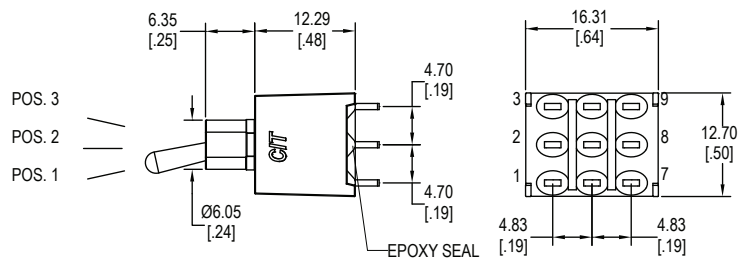
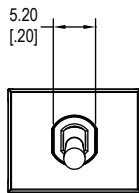

Actuator Options

Actuator lengths shown with N bushing, subtract 2.15mm for E bushing

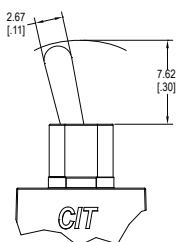

T

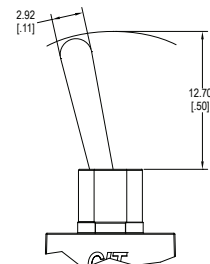

S

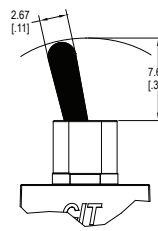

P1

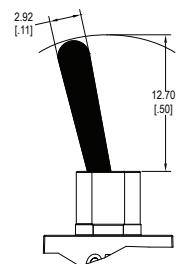

P2

Bushing Options

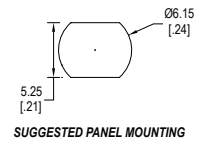
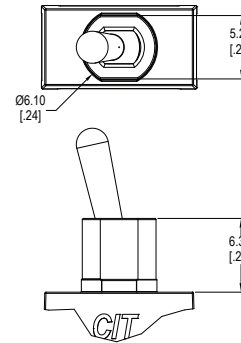
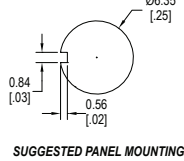
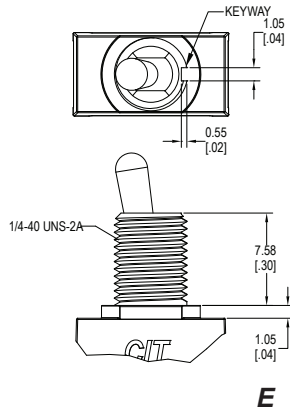

E

N

Terminal Options

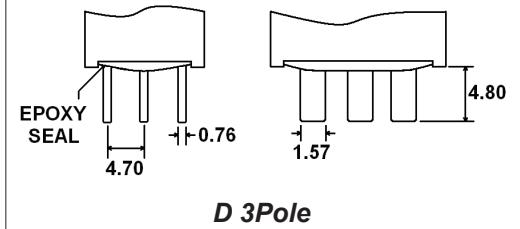
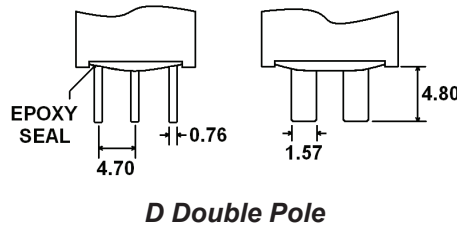
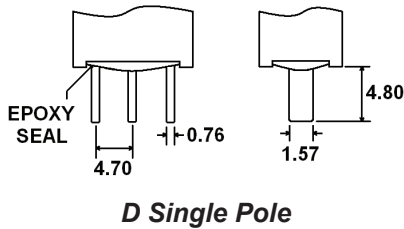
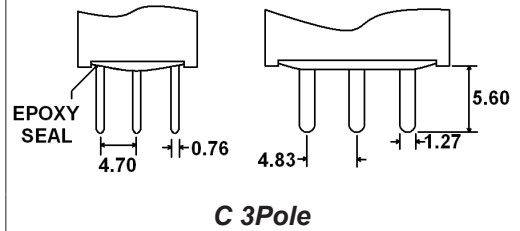
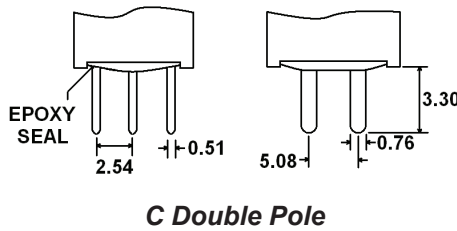
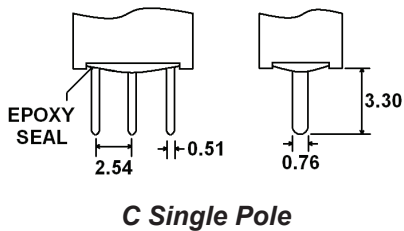
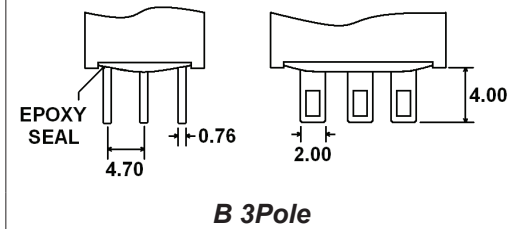
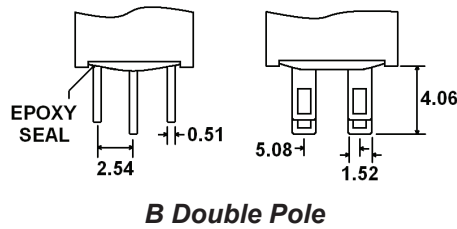
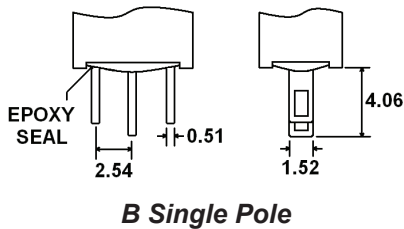

Terminal Options

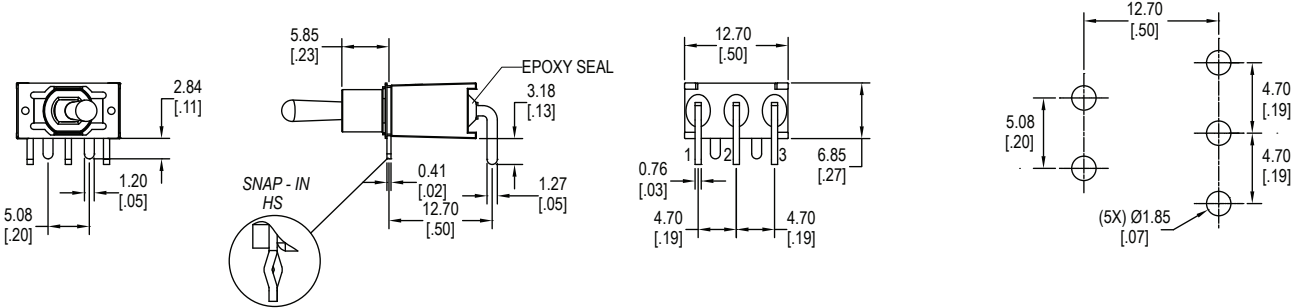

H (HS - Snap In) = Horizontal mount, right angle PC pins, single pole

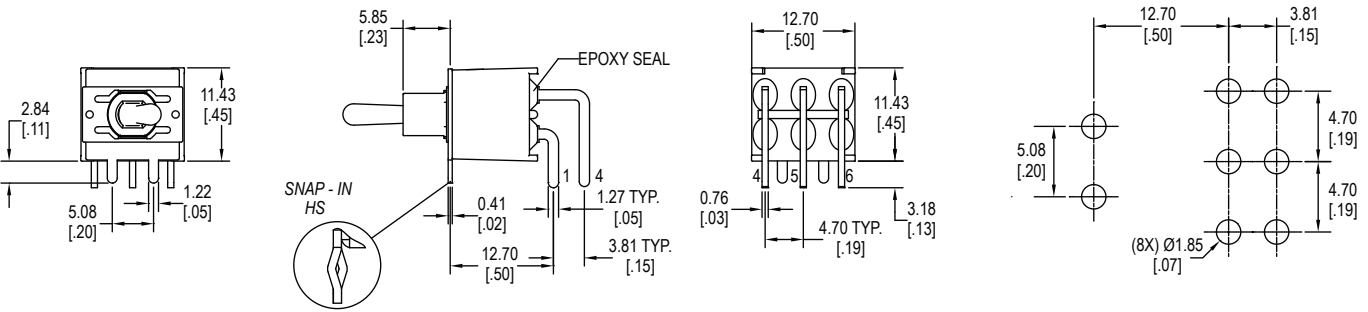

H (HS - Snap In) = Horizontal mount, right angle PC pins, double pole

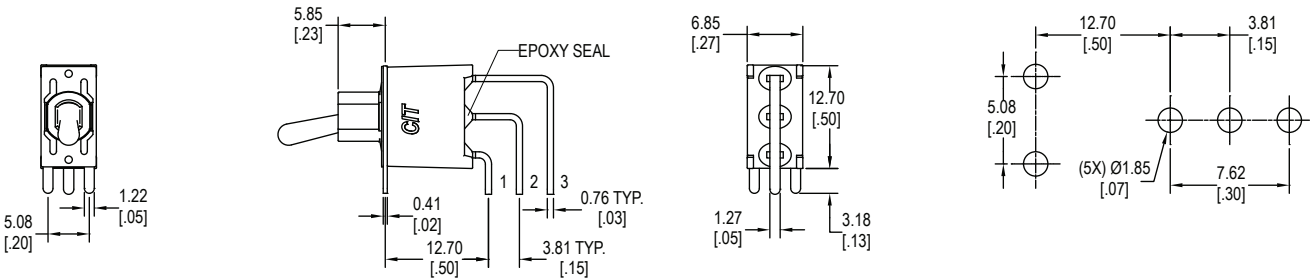

V = Vertical mount, right angle PC pins, single pole

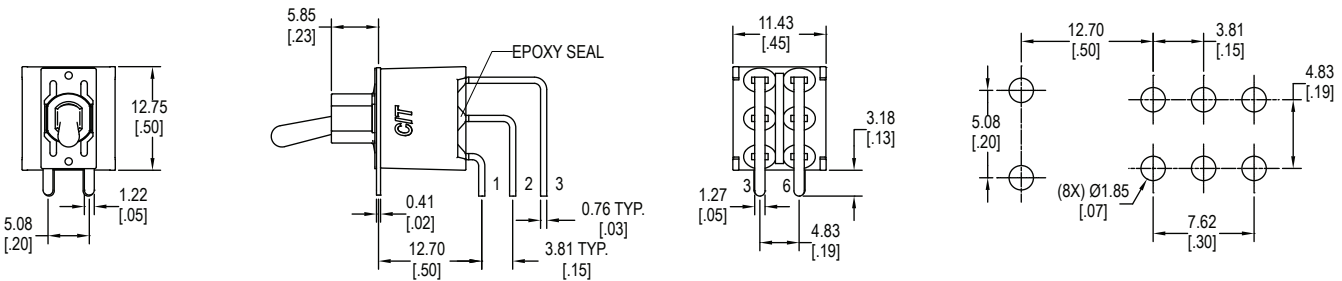

V = Vertical mount, right angle PC pins, double pole

Terminal Options

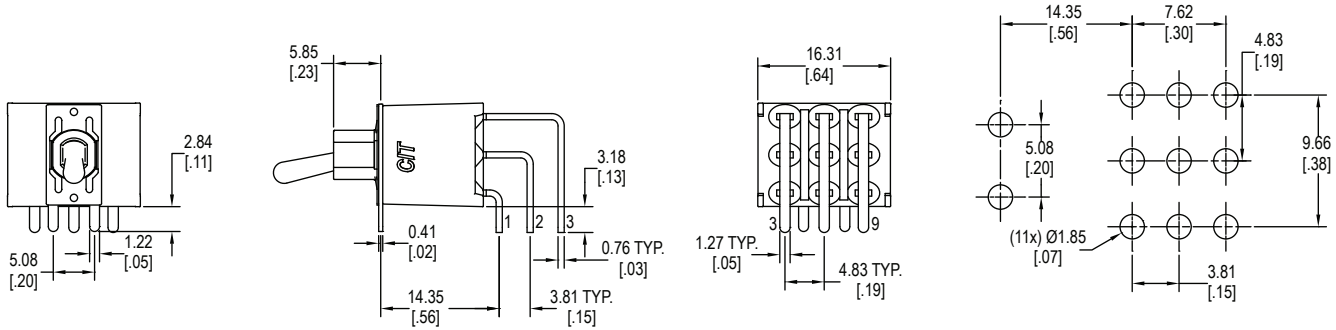

V = Vertical mount, right angle PC pins, three pole

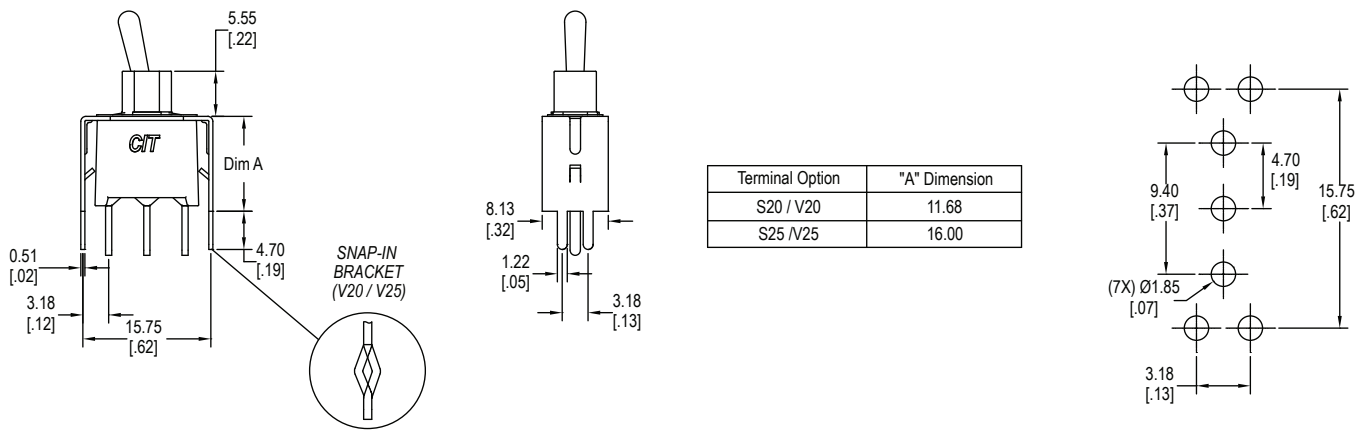

S20 / S25 (V20 / V25 - Snap In bracket) = PC pins with support bracket, single pole

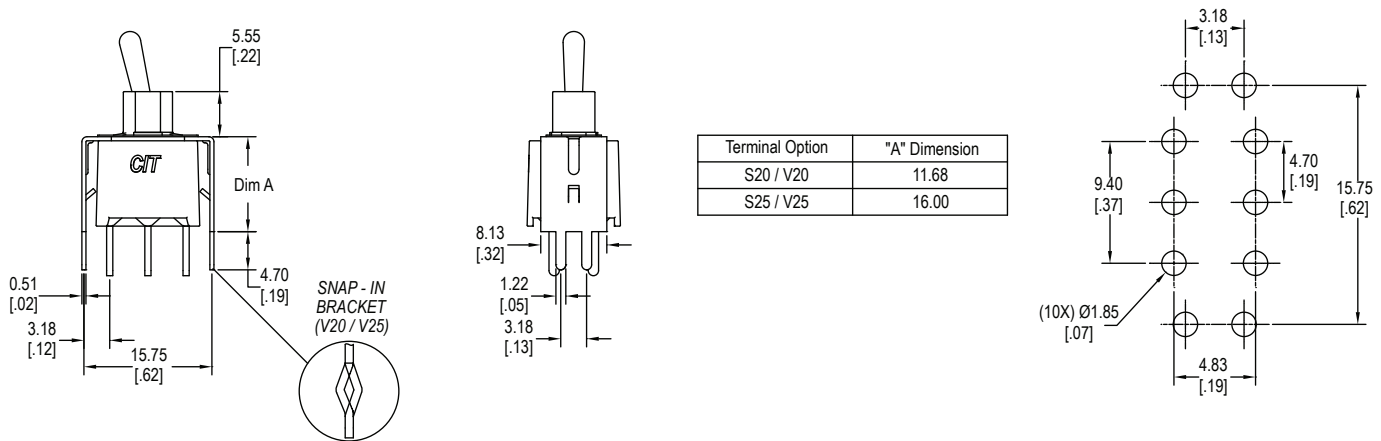

S20 / S25 (V20 / V25 - Snap In bracket) = PC pins with support bracket, double pole

Terminal Options

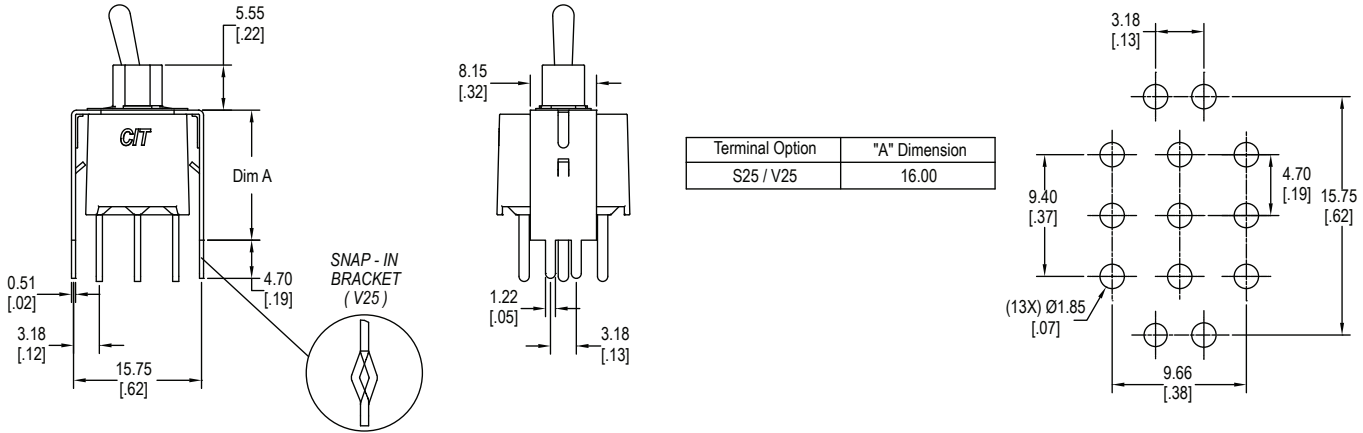

S20 / S25 (V20 / V25 - Snap In bracket) = PC pins with support bracket, three pole

Contact Options

Designator	Contact Material	Terminal Material	Electrical Ratings
Q	Silver Plating	Silver Plating	5A @ 120VAC, 28VDC; 2A @ 250VAC
R	Gold over Nickel Plating	Gold over Nickel Plating	0.4VA max @ 20VAC or VDC max
G	Gold over Silver Plating	Gold over Silver Plating	0.4VA max @ 20VAC or VDC max or 5A @ 120VAC, 28VDC; 2A @ 250VAC

Hardware

Two hex nuts, one lock washer & one locking ring supplied standard with threaded bushings

For use with E bushings

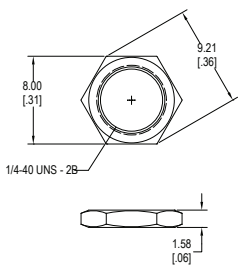

Hex Nut

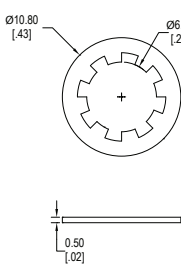

Lock Washer

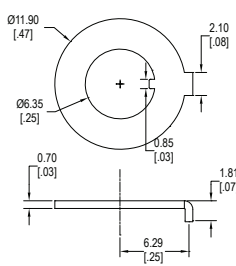

Locking Ring

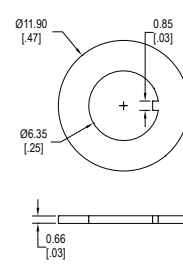

Washer

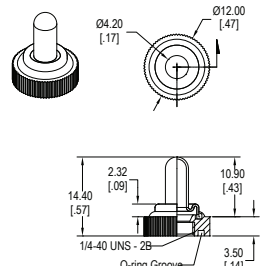

Sealed Boot

Dress Nuts

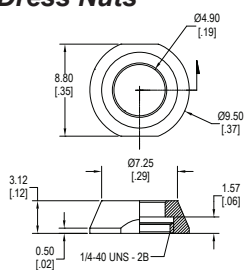

A

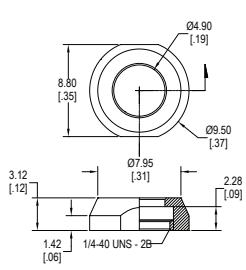

B

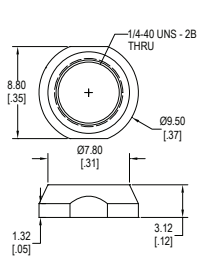

C

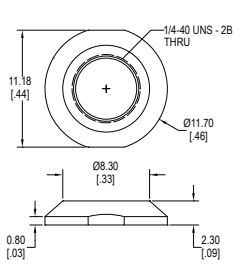

D

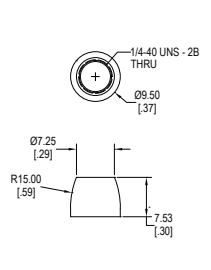

E