

L0603C3R9KSMST

Aliases (L0603C3R9KSMST)

Obsolete

KEMET, L-SMS, Commercial Grade, 3.9 uH, 10%

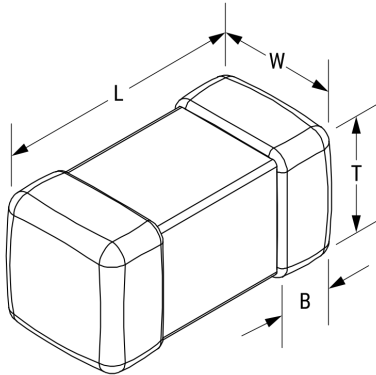

Click [here](#) for the 3D model.

Dimensions

Chip Size	0603
L	1.6mm +/-0.15mm
W	0.8mm +/-0.15mm
T	0.8mm +/-0.15mm
LL	0.3mm +/-0.2mm
B	0.3mm +/-0.2mm

Packaging Specifications

Packaging	T&R
Packaging Quantity	4000

General Information

Series	L-SMS
Style	SMD Chip
Description	Shielded, Surface Mount Inductor
Features	Standard Type
RoHS	Yes
Core	Ceramic
Winding Type	Multilayer
Notes	Suggested Replacement - https://www.chilisin.com/en-global/Inductor/Product/BSCL_160808/BSCL001608083R9K00 .

Specifications

Inductance	3.9 uH
Inductance Tolerance	10%
Temperature Range	-40/+85°C
Current	15 mAmps (MAX)
DC Resistance	1.7 Ohms
Quality Factor	35 at 10 MHz
Self-Resonant Frequency	36 MHz