



# SB140L SERIES

## LOW VF SCHOTTKY RECTIFIER

**VOLTAGE** 40 to 60 Volts **CURRENT** 1 Ampere

**DO-41** Unit : inch(mm)

### FEATURES

- Plastic package has Underwriters Laboratory Flammability Classification 94V-O utilizing Flame Retardant Epoxy Molding Compound
- Exceeds environmental standards of MIL-S-19500/228
- For use in low voltage, high frequency inverters, free wheeling, and polarity protection applications
- Low forward voltage drop, low power loss
- In compliance with EU RoHS 2002/95/EC directives

### MECHANICAL DATA

- Case: DO-41 Molded plastic
- Terminals: Axial leads, solderable per MIL-STD-750, Method 2026
- Polarity: Color band denotes cathode end
- Mounting Position: Any
- Weight: 0.0118 ounces, 0.336grams

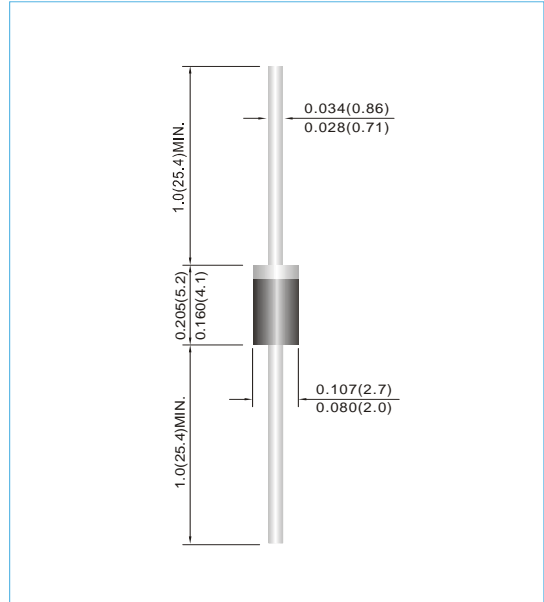

## MAXIMUM RATINGS AND ELECTRICAL CHARACTERISTICS

Ratings at 25°C ambient temperature unless otherwise specified. Single phase, half wave, 60 Hz, resistive or inductive load.

PARAMETER	SYMBOL	SB140L	SB145L	SB160L	UNITS
Maximum Recurrent Peak Reverse Voltage	$V_{RRM}$	40	45	60	V
Maximum RMS Voltage	$V_{RMS}$	28	31.5	42	V
Maximum DC Blocking Voltage	$V_{DC}$	40	45	60	V
Maximum Average Forward Rectified Current	$I_{F(AV)}$	1			A
Peak Forward Surge Current : 8.3ms single half sine-wave superimposed on rated load (JEDEC method)	$I_{FSM}$	90			A
Typical Forward Voltage at 0.5A	$V_F$	0.37		0.39	V
Maximum Forward Voltage at 1.0A	$V_F$	0.45		0.50	V
Maximum DC Reverse Current at Rated DC Blocking Voltage	$I_R$		0.1	10	mA
Typical Thermal Resistance	$R_{\theta JA}$ $R_{\theta JL}$		70	25	°C / W
Operating Junction and Storage Temperature Range	$T_J, T_{STG}$	-55 to +125			°C

### NOTES :

1. Thermal resistance from junction to ambient 0.375" (9.5 mm) lead length mounted on PCB with min. pad layout.
2. Thermal resistance from junction to lead at 0.375" (9.5 mm) lead length with both leads attached to heatsinks.



# SB140L SERIES

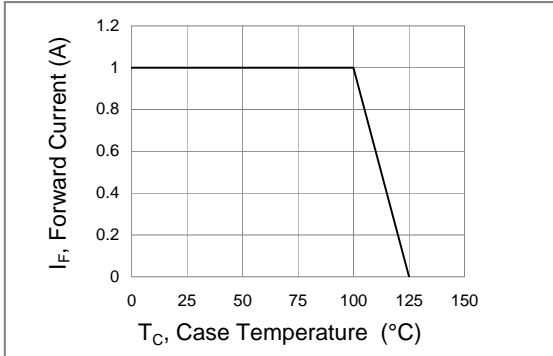

**Fig.1 Forward Current Derating Curve**

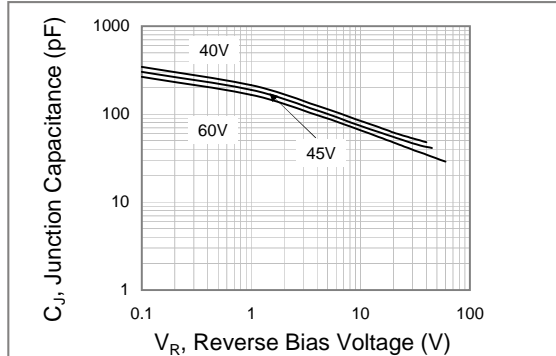

**Fig.2 Typical Junction Capacitance**

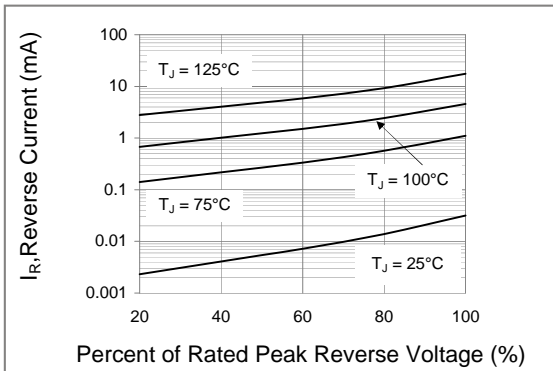

**Fig.3 SB140L Typical Reverse Characteristics**

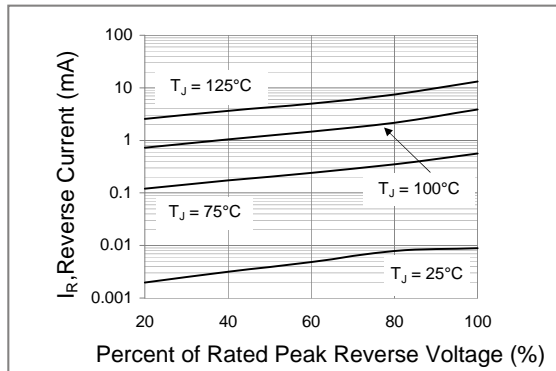

**Fig.4 SB145L Typical Reverse Characteristics**

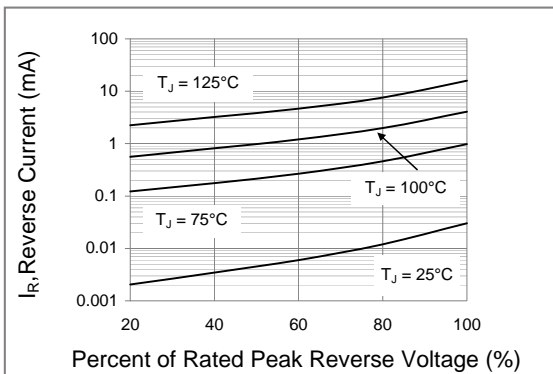

**Fig.5 SB160L Typical Reverse Characteristics**

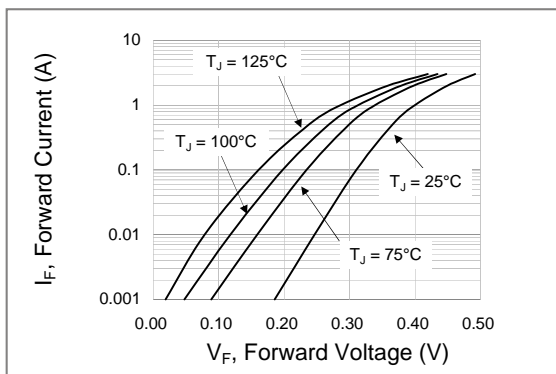

**Fig.6 SB140L Typical Forward Characteristics**

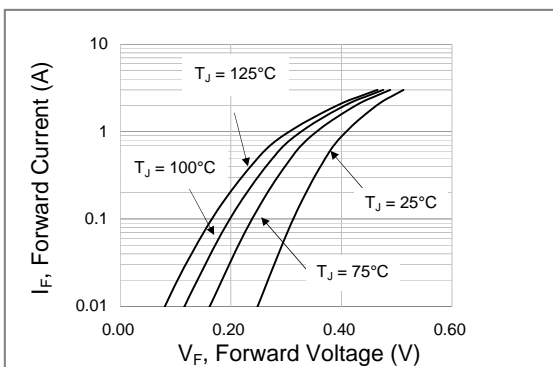

**Fig.7 SB145L Typical Forward Characteristics**

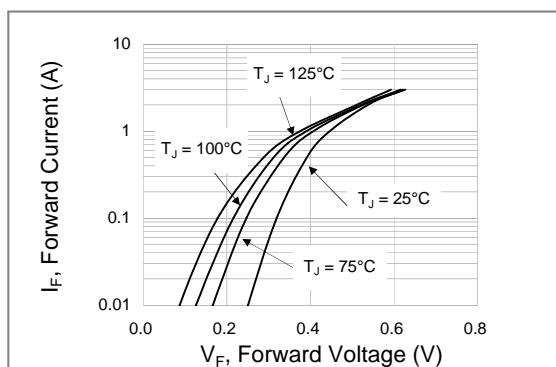

**Fig.8 SB160L Typical Forward Characteristics**