

W-IE-NE-R VPX340DMA

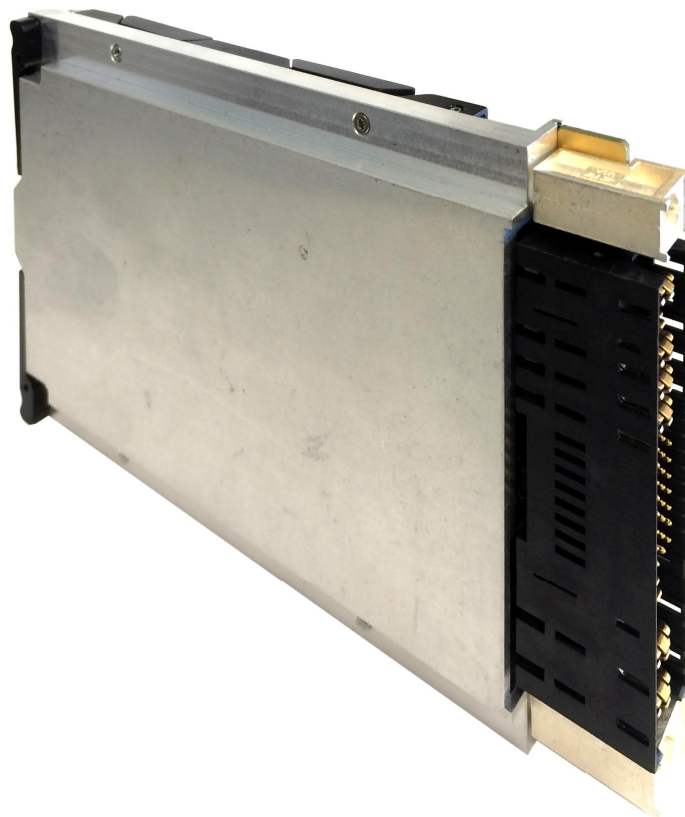

3U / 4HP / 400W

VPX Power Supply

Manual

General Remarks

The only purpose of this manual is a description of the product. It must not be interpreted as a declaration of conformity for this product including the product and software.

W-IE-NE-R revises this product and manual without notice. Differences between the description in manual and the product are possible.

W-IE-NE-R excludes completely any liability for loss of profits, loss of business, loss of use or data, interrupt of business, or for indirect, special incidental, or consequential damages of any kind, even if W-IE-NE-R has been advised of the possibility of such damages arising from any defect or error in this manual or product.

Any use of the product which may influence health of human beings requires the express written permission of W-IE-NE-R.

Products mentioned in this manual are mentioned for identification purposes only. Product names appearing in this manual may or may not be registered trademarks or copyrights of their respective companies.

No part of this product, including the product and the software may be reproduced, transmitted, transcribed, stored in a retrieval system, or translated into any language in any form by any means without the express written permission of W-IE-NE-R.

Table of contents:

1	GENERAL DESCRIPTION	4
1.1	Overview.....	4
1.2	Functional description.....	4
2	SPECIFICATIONS.....	6
2.1	Standard Input Voltage Specification	6
2.2	Output Voltage Specification	6
2.3	Technical Specification Table	6
2.4	MIL STD 810 (Shock / Vibration / Ambient Temperature / Environment).....	8
2.5	MIL-STD-461F (EMI) Compliance	9
2.6	MIL-STD-704 Compliance	10
2.7	MIL-STD-1275D Compliance	11
2.8	P0 Connector Pin-Layout (as per VITA62).....	13
2.9	USB Connector & LED Status Indicator	14
3	MECHANICAL LAYOUT	15
4	I2C DOCUMENTATION VERSION 1.2 (A7.X BOARDS).....	16
4.1	Device Setup	16
4.2	I2C Device Address Byte.....	16
4.3	Device Access	16
4.3.1	A Typical Slave I2C™ Message: Multiprocessor Command/Status	16
4.3.2	Data Mapping.....	16
4.4	Timing	20
4.4.1	I2C™ BUS START/STOP BITS TIMING CHARACTERISTICS (SLAVE MODE).....	20
4.4.2	I2C™ BUS DATA TIMING CHARACTERISTICS (SLAVE MODE)	20
4.4.3	I2C™ BUS DATA TIMING REQUIREMENTS (SLAVE MODE)	21
4.5	User Software	22

1 General Description

The WIENER VPX340DMA is a COTS, single stage, 28V DC input voltage based, conduction cooled VPX power supply with 400W output power according to the ANSI/VITA 62.0 specification. The power supply can be used to power a VPX chassis and will fit into the standard envelope defined by VITA 46.0 specifications.

Using state of the art switching power technology a wide input range voltage range as well as high overall efficiency is achieved. An embedded microprocessor allows monitoring and control via I²C bus. No electrolytic capacitors are used.

The 400W VPX power supply mechanical dimensions are 3U x 4HP (0.80" slot). It is outfitted with connectors, keying and alignment mechanism as per VITA 62.

The VPX340DMA is designed & tested in compliance with relevant MIL STD 461, 704 and 1275.

1.1 Overview

1.2 Functional description

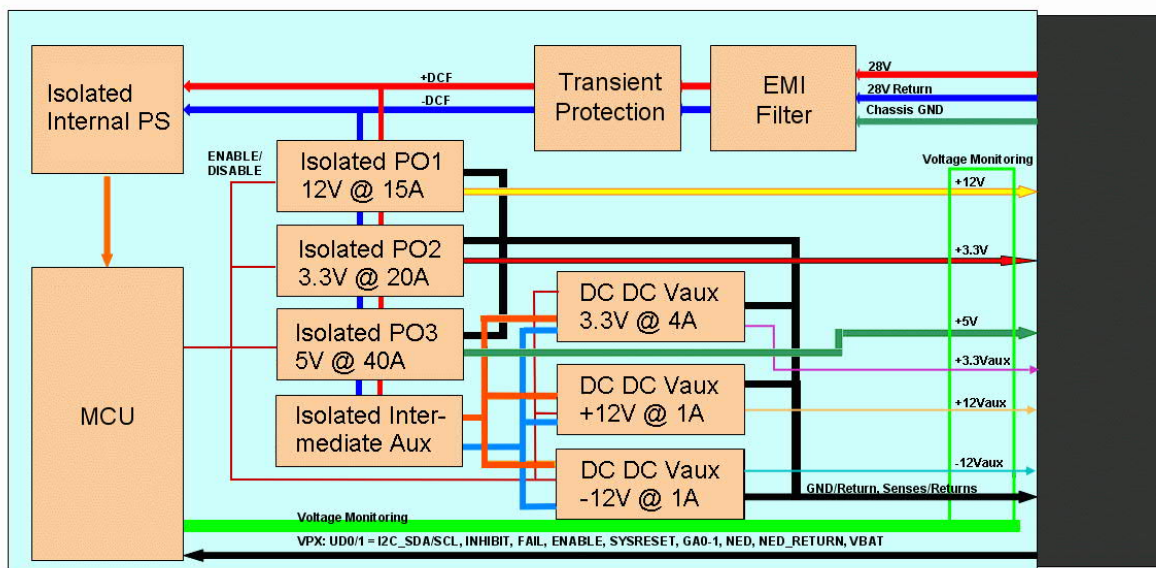

Figure 1: VPX-340DMA Block-Diagram

WARNING: VPX340DMA is a conduction cooled power supply intended to be used with a wedge-lock heatsink and VITA 62 backplane. Failure to properly regulate wedge-lock temperature within the specified limits may result in damage to the power supply.

NOTICE: VITA 62 (4.6.3.12) systems support Remote Sense & Sense Return Pins that are used to accommodate for power distribution losses (i.e. voltage drops across the connector and PCB traces). VPX340DMA contains three sense lines (PO1_SENSE, PO2_SENSE, PO3_SENSE) and one sense return line (SENSE_RETURN) that require connection to the backplane in order provide point of load voltage regulation. The connection is typically provided through a jumper (e.g. 0Ω resistor) located on the backplane. Refer to backplane documentation to ensure the necessary sense and sense return jumpers are installed.

NOTICE: VITA 62 (4.6.3.10) systems support a Signal Return Pin (SIGNAL_RETURN) that is used as the return path for digital signals distributed across the backplane. VPX340DMA requires SIGNAL_RETURN

to be connected to the backplane's ground plane. This connection is typically provided through a jumper (e.g. 0Ω resistor) located on the backplane. Refer to backplane documentation to ensure SIGNAL_RETURN jumper is installed.

TERMINATE PO1 SENSE, PO2 SENSE, PO3 SENSE, SENSE_RETURN, & SIGNAL_RETURN ON THE VITA 62 BACKPLANE!

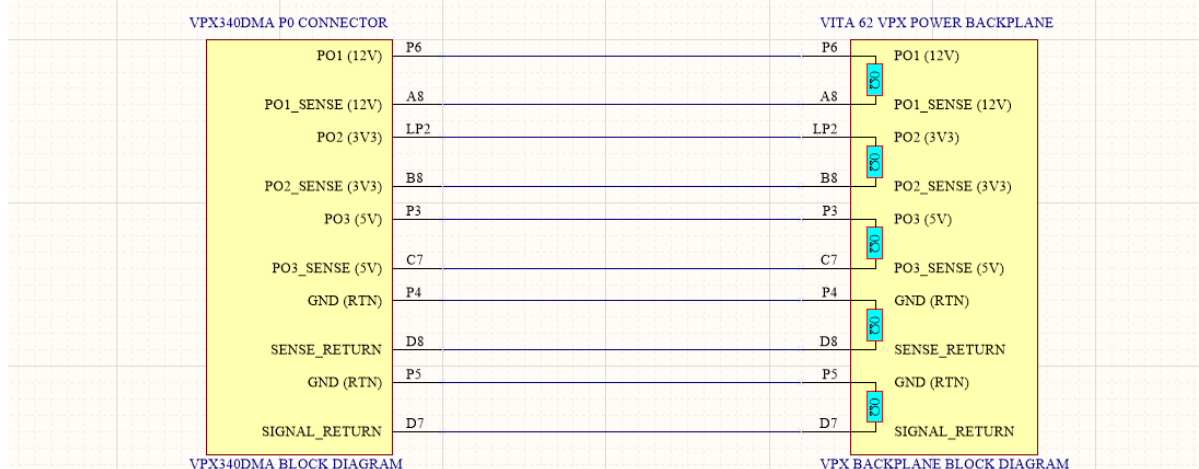

Figure 1.1: Block Diagram of VPX340DMA and VITA 62 Power Backplane. VPX340DMA requires PO1_SENSE, PO2_SENSE, PO3_SENSE, SENSE_RETURN, & SIGNAL_RETURN to be terminated on the VITA 62 Power Backplane. Verify that these connections are made on your VPX Power Backplane.

RECOMMENDATION: VPX340DMA has been successfully tested and deployed with VITA46/62 VPX Power Backplanes and conduction cooled chassis manufactured by Hartmann Electronics. Hartmann Electronics has over 35 years of experience designing high-speed backplanes, please see:

<https://www.hartmann-electronic.com/>

Support for power supply specific signals: ENABLE*, INHIBIT*, FAIL* and UD (user defined) signals. These input/output signals are low current open collector circuits with electrical characteristics defined per VITA 46 section 4.8.12.1.

NOTICE: NED (C3), NED_RETURN (D3), UD2-4 (B1, C1, D1), SM2-3 (A6, B6), VBAT (A2), & PO1-3_SHARE (A7, B7, C7) are open circuit/no connection on VPX340DMA.

Control Inputs		Power Outputs	
ENABLE*	INHIBIT*	3.3V_AUX	PO1, PO2, PO3, +12V_AUX, and -12V_AUX
High	High	Off	Off
High	Low	Off	Off
Low	High	On	On
Low	Low	On	Off

Communication interface: I²C communication interface via SM0 (C5) and SM1 (D5). Additional I²C connection at UD0 (A1) and UD1 (B1) is set by internal jumper (can be removed by factory).

Communication Features (see paragraph 4):

- Remote On / Off

- DC-IN status and measured voltage and current
- Global status, Temperatures
- Voltage, current and status of individual output power modules

2 Specifications

2.1 Standard Input Voltage Specification

+28 V DC nominal, 15 V ... 40 V DC input range

UV lockout at 11V

Outfitted with Reverse Polarity Protection

2.2 Output Voltage Specification

Maximum output power: limited to 400 W

VPX standard outputs as per VITA 62:

Channel	Voltage	Current	Power
VS1	+12.00 V	15 A	180 W
VS2	+3.30 V	20 A	66 W
VS3	+5.00 V	40 A	200 W
VAUX1 (+12)	+12 V	1 A	12 W
VAUX2 (-12)	-12 V	1 A	12 W
VAUX3 (3.3)	+3.3 V	4 A	12 W
Total max			400W

Noise and ripple (PARD) as per VITA 62 specification:

+5 V / +3.3 V: 50 mV, see [VITA 46.0] Rule 3-6 / 3-9]

+12 V / -12 V: <120 mV peak-to-peak, measured over a range of 0 to 20 MHz.

Overall Efficiency: -85% ...90% (dependent on output power distribution),
-87% at full load of 400W with power distributed across all outputs.
See Figure 2 for efficiency curves.

Input to Output Insulation: 1500 V

2.3 Technical Specification Table

Form Factor	3U VPX CC
Pitch	4HP / 0.8 inch
Weight	0.60 kg / 1.3 lbs
Storage Temperature	-55 °C to 105 °C
Operating Temperature	-40 °C to 85 °C (Operating Temperature is referenced at wedge-lock. Failure to regulate wedge-lock temperature may result in damage)

Input to Output Insulation	1500 V
Input to Case Ground Isolation	500 V
Output to Case Ground Isolation	500 V
Maximum Output Power	400 W (derate max power from 400W to 200W (linear) for 60 °C to 85 °C operation)
Maximum Input Power	~450 W
Maximum Dissipated Power @ max. Power	~50 W
Minimum Turn ON Voltage	14 V
Minimum Turn OFF Voltage	11 V
Maximum Continuous/Peak Input Voltage	40 V / \pm 250 V (<1 ms spike)
Input Overvoltage Protection:	Outputs disable if input voltage exceeds 42 VDC for > 600 ms (10 second auto-restart)
Temperature Protection Sensing Point (internal)	125 °C (Outputs disable when internal PCB temperature exceeds threshold)
Maximum Internal Working Temperatures	125 °C
Case Ground to Safety Ground Resistance	< 10 m Ω
Maximum Input Line Inductance	10 μ H

Main Power

Maximum Currents 12V / 3V3 / 5V	15 A / 20 A / 40 A
Fixed Switching Frequencies 12V / 3V3 / 5V	300 kHz / 220 kHz / 410 kHz
Peak Efficiencies 12V / 3V3 / 5V	90% / 90% / 90%
Max. Output Ripple and Noise: 12V / 3V3 / 5V (0-20 MHz Bandwidth)	40 mVrms / 10 mVrms / 20 mVrms <120 mVpp / <50 mVpp / <50 mVpp
Line Regulation: 12V / 3V3 / 5V.	<10 mV / <10 mV / <10 mV
V _{in} =V _{in,min} to V _{in,max} , I _o and T _c fixed	< 0.1%
Load Regulation: 12V / 3V3 / 5V	<10 mV / <10 mV / <50 mV
Maximum output voltage (sense lines open)	12.1 V / 3.4 V / 5.2 V
Temperature Protection Sensing Point (identical to case)	85 °C (Latching)
Load Transient Recovery Time (no load to full load change condition)	~1 ms

Auxiliary +/-12V, 3.3V Power

Maximum Current	1.0 A / 1.0 A / 4.0 A
Load Dependent Switching Frequency	600 Hz - 130 kHz

Peak Efficiencies ~80%
 Max. Output Ripple and Noise (0-20 MHz Bandwidth) <120 mVpp / <50 mVpp / <50 mVpp
 Load Transient Recovery Time (no load to full load change condition) ~1 ms

Power Supply Efficiency

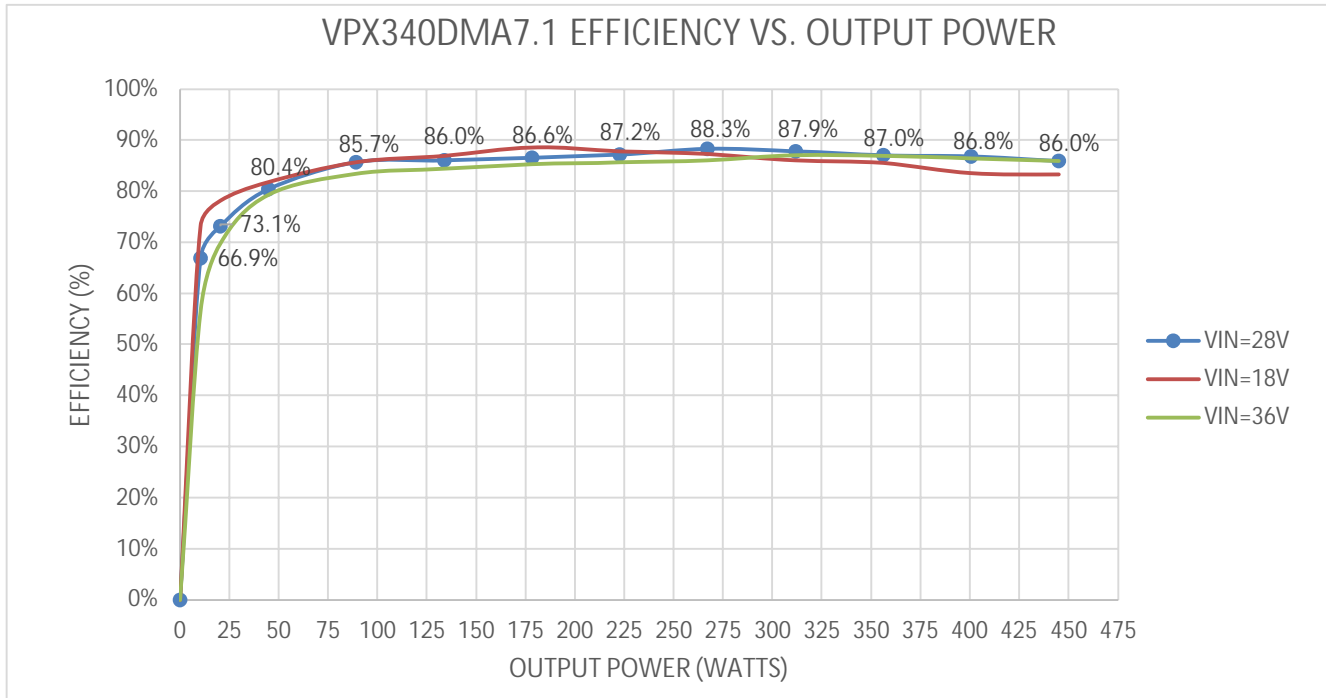

Figure 2: VPX-340DM7.1 Efficiency versus Output Power for VITA 62 nominal input voltage range. VPX340DMA is designed to operate with input voltages between 18V-36V DC and optimized for 28V DC. Efficiency curve was generated from empirical data with power distributed across PO1, PO2, & PO3 outputs.

2.4 MIL STD 810 (Shock / Vibration / Ambient Temperature / Environment)

Ruggedized construction to meet shock and vibration requirements. Compliance tests performed by 3rd party and reports available upon request.

ENVIRONMENT:	TEST REFERENCE / DETAILS	RESULT:
Altitude	MIL STD 810G Method 500 Procedure II	PASS
Shock	Operating Shock Class OS2 as per MIL STD 810G Method 516 Procedure I	PASS
Vibration	MIL STD 810G Method 514.6 Procedure I, and VITA 47 paragraph 4.4.3 / Vibration Class V3	PASS

Storage Temperature: -55 °C to 105 °C

Operating Temperature: -40 °C to 85 °C (derate max power from 400W to 200W (linear) for 60 °C to 85 °C operation)

Standard acrylic conformal coating (e.g. HumiSeal Type 1B31 or similar) to withstand sand, dust and salt atmosphere. Alternate conformal coating with Parylene. Other options are available upon request.

2.5 MIL-STD-461F (EMI) Compliance

Designed & tested in compliance with sections CE102, CS101, CS114, CS115, CS116. Compliance tests performed by 3rd party and reports available upon request.

EMC STANDARD:	TEST CONDITIONS: LINE, LOAD, EXTERNAL FILTER	RESULT:
MIL-STD-461F CE102	Input Voltage = 28V, Output Power = 400W, No external filter needed, 5µH LISN exception (MIL-STD-461F, A.4.3.6)	PASS
MIL-STD-461F CS101	Input Voltage = 28V, Output Power = 40W, No external filter needed, 5µH LISN exception (MIL-STD-461F, A.4.3.6)	PASS
MIL-STD-461F CS114	Input Voltage = 28V, Output Power = 400W, No external filter needed, 5µH LISN exception (MIL-STD-461F, A.4.3.6)	PASS
MIL-STD-461F CS115	Input Voltage = 28V, Output Power = 400W, No external filter needed, 5µH LISN exception (MIL-STD-461F, A.4.3.6)	PASS
MIL-STD-461F CS116	Input Voltage = 28V, Output Power = 400W, No external filter needed, 5µH LISN exception (MIL-STD-461F, A.4.3.6)	PASS

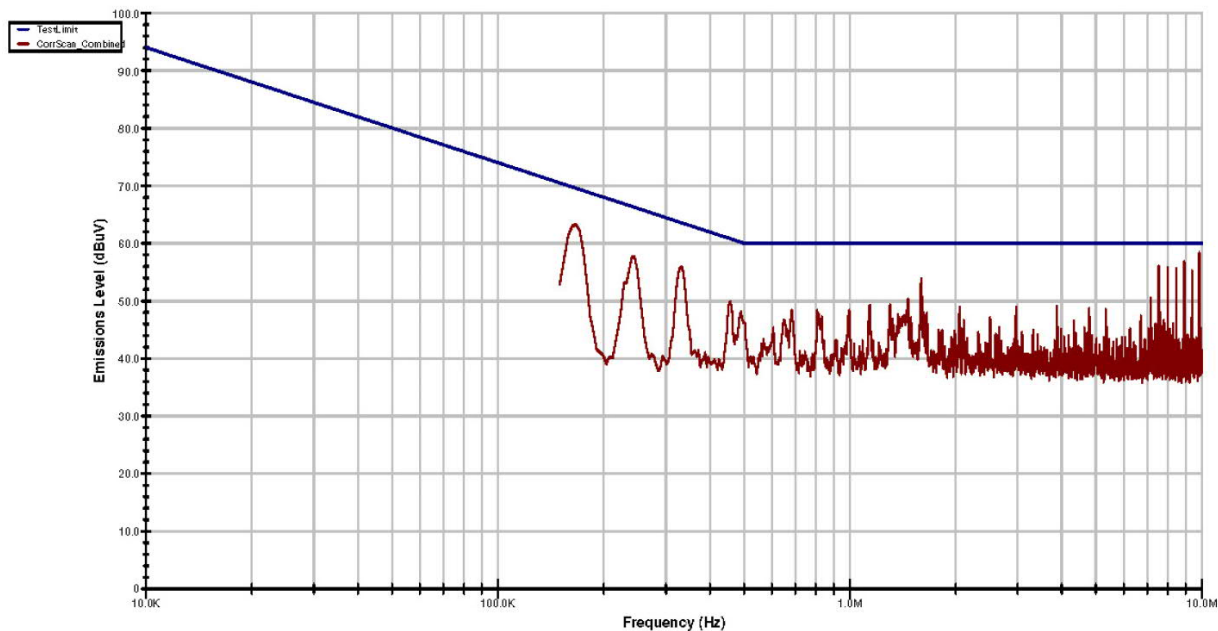

Figure 3: MIL-STD-461 CE102 limit line (blue) and VPX340DMA7.1 CE102 test results (red).

2.6 MIL-STD-704 Compliance

Designed & tested in compliance for normal and abnormal transients and distortion spectrum. External hold-up circuit optional. Compliance tests performed by 3rd party and reports available upon request.

EMC STANDARD:	TEST CONDITIONS: LINE, LOAD, EXTERNAL FILTER	RESULT:
MIL-STD-704F LDC105 Normal Voltage Transients	Input Voltage = 28V, Output Power = 192W, No external filter needed	PASS
MIL-STD-704F LDC302 Abnormal Voltage Transients	Input Voltage = 28V, Output Power = 192W, No external filter needed	PASS
MIL-STD-704F LDC103 Voltage Distortion Spectrum	Input Voltage = 28V, Output Power = 192W, No external filter needed	PASS

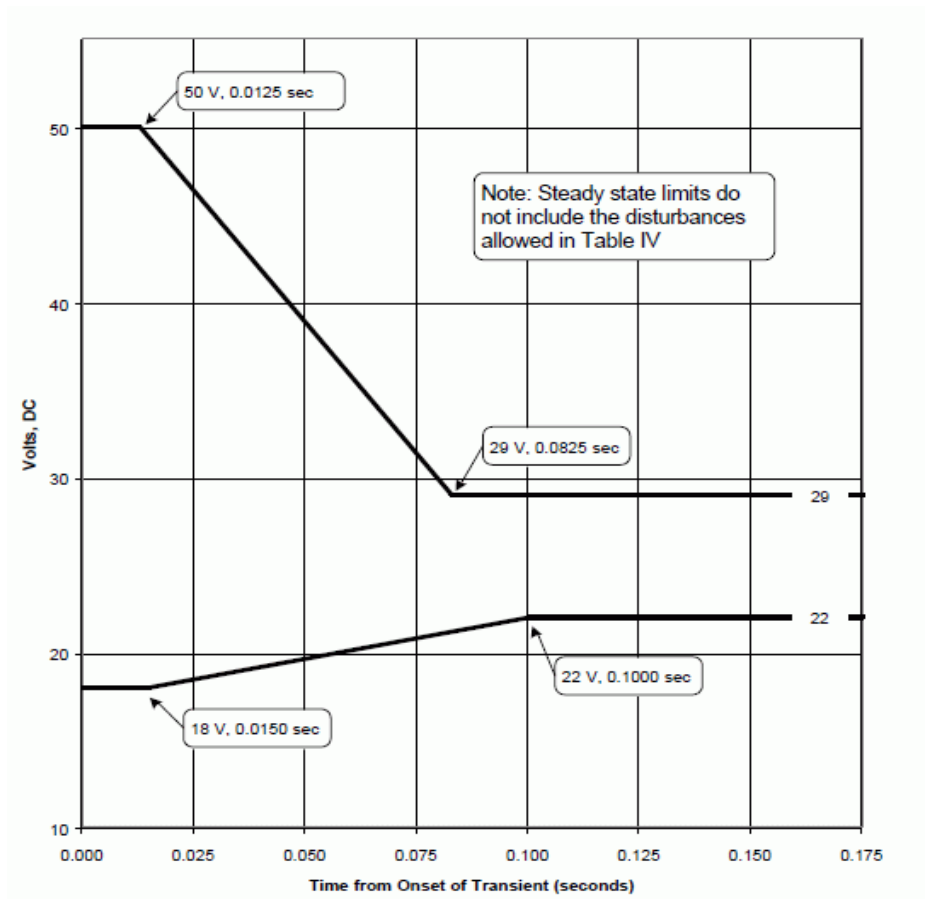

Figure 4: MIL-STD-704F Envelope for normal voltage transients for 28 VDC Systems

2.7 MIL-STD-1275D Compliance

Designed & tested in compliance for ripple, surge, & spikes. Compliance tests performed by 3rd party and reports available upon request.

EMC STANDARD:	TEST CONDITIONS: LINE, LOAD, EXTERNAL FILTER	RESULT:
MIL-STD-1275D 5.3.2.2 Exported Voltage Spikes	Input Voltage = 28V, Output Power = 400W, No external filter needed	PASS
MIL-STD-1275D 5.3.2.3 Imported Voltage Spikes	Input Voltage = 28V, Output Power = 400W, No external filter needed, Normal Mode & Generator Mode	PASS
MIL-STD-1275D 5.3.2.4 Imported Voltage Surges	Input Voltage = 28V, Output Power = 400W, No external filter needed, Normal Mode & Generator Mode	PASS
MIL-STD-1275D 5.3.2.5 Imported Ripple Voltage	Input Voltage = 28V, Output Power = 40W, No external filter needed	PASS

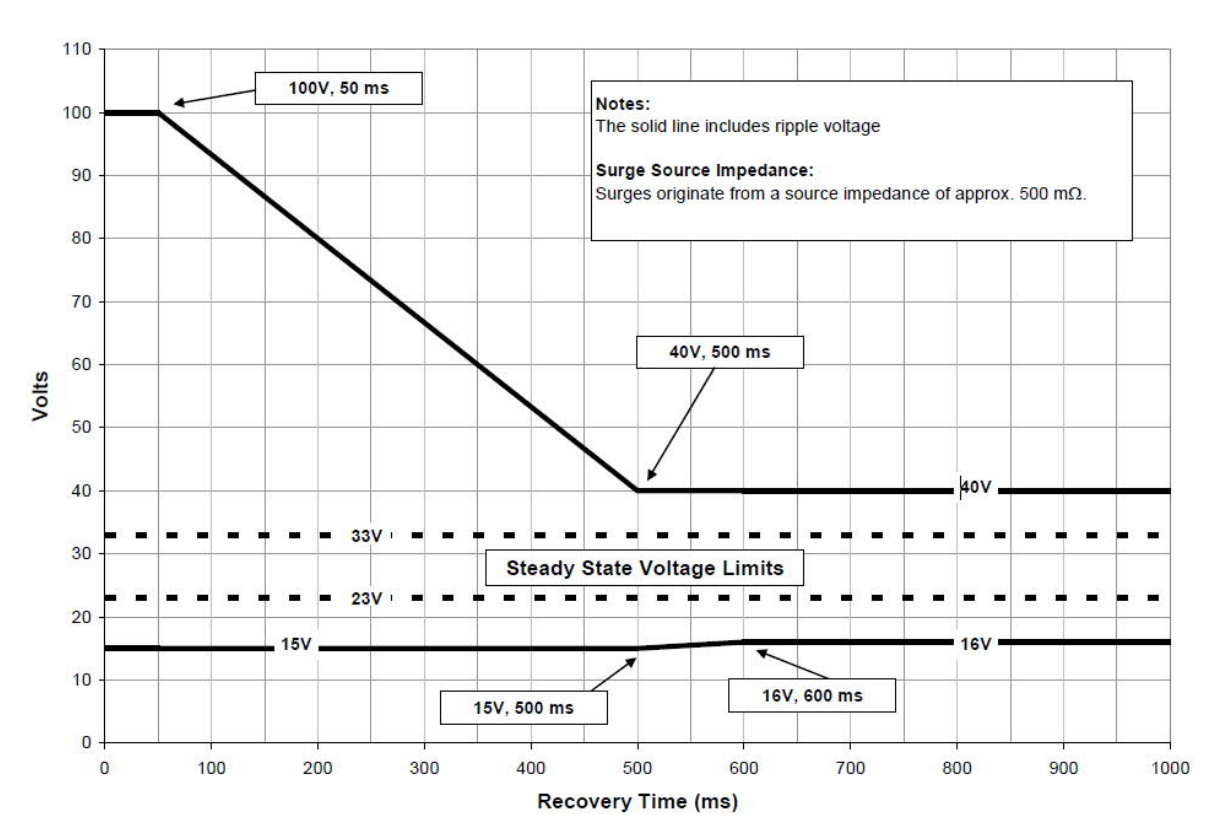

Figure 5: MIL-STD-1275D Envelope of surges in Generator-only Mode for 28 VDC Systems.

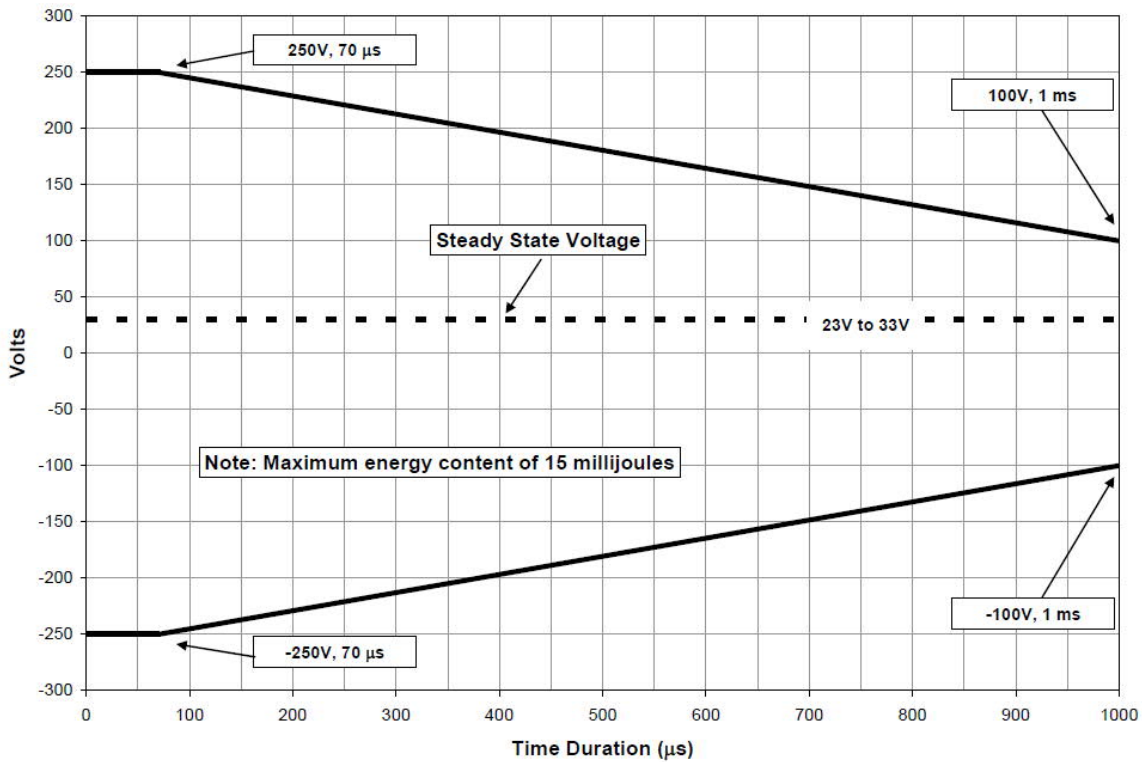
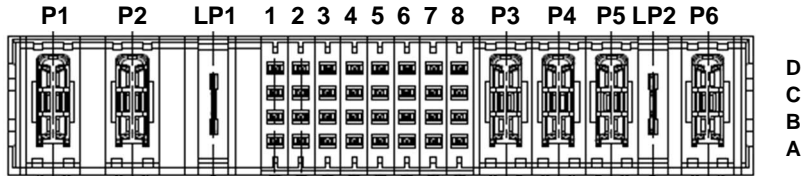

Figure 6: MIL-STD-1275D Envelope of spikes in Generator-only Mode for 28 VDC Systems.



2.8 P0 Connector Pin-Layout (as per VITA62)

P0 (3U)	TE Connectivity	Foxconn
Power Supply	6450849-7	HM811C3-B84F
Backplane	1-6450869-4	HM826B3-B64F



Pin Number	Rated Current (A)	Pin Name
P1	40A	- DC_IN
P2	40A	+ DC_IN
LP1	20A	CHASSIS
A1	<1A	UD1
B1	<1A	UD2
C1	<1A	UD3
D1	<1A	UD4
A2	<1A	VBAT
B2	<1A	FAIL*
C2	<1A	INHIBIT*
D2	<1A	ENABLE*
A3	<1A	UD0
B3	<1.5A	+12V_AUX
C3	<1A	NED
D3	<1A	NED_RETURN
A4	<1.5A	3,3V_AUX
B4	<1.5A	3,3V_AUX
C4	<1.5A	3,3V_AUX
D4	<1.5A	3,3V_AUX
A5	<1A	GA0*
B5	<1A	GA1*
C5	<1A	SM0
D5	<1A	SM1
A6	<1A	SM2
B6	<1A	SM3
C6	<1.5A	-12V_AUX
D6	<1A	SYSRESET*
A7	<1A	PO1_SHARE (VS1)
B7	<1A	PO2_SHARE (VS2)
C7	<1A	PO3_SHARE (VS3)
D7	<1A	SIGNAL_RETURN
A8	<1A	PO1_SENSE (VS1)
B8	<1A	PO2_SENSE (VS2)
C8	<1A	PO3_SENSE (VS3)
D8	<1A	SENSE_RETURN
P3	40A	PO3 (VS3)
P4	40A	POWER_RETURN
P5	40A	POWER_RETURN
LP2	20A	PO2 (VS2)
P6	40A	PO1 (VS1)

2.9 USB Connector & LED Status Indicator

VPX340DMA is equipped with a Micro B USB 2.0 connector. This interface enables communication with a Windows PC running User Software. See section 4.5 of this manual for details on User Software.

VPX340DMA is equipped with a LED Status Indicator: Flashing GREEN LED indicates that the firmware is running. Solid BLUE LED indicates that the VITA 62 ENABLE* Switch is active (i.e. all outputs are energized). Normal operation is a flashing GREEN LED & Solid BLUE LED on (when ENABLE* active). Contact WIENER for support if LED Status indicates otherwise.

3 Mechanical Layout

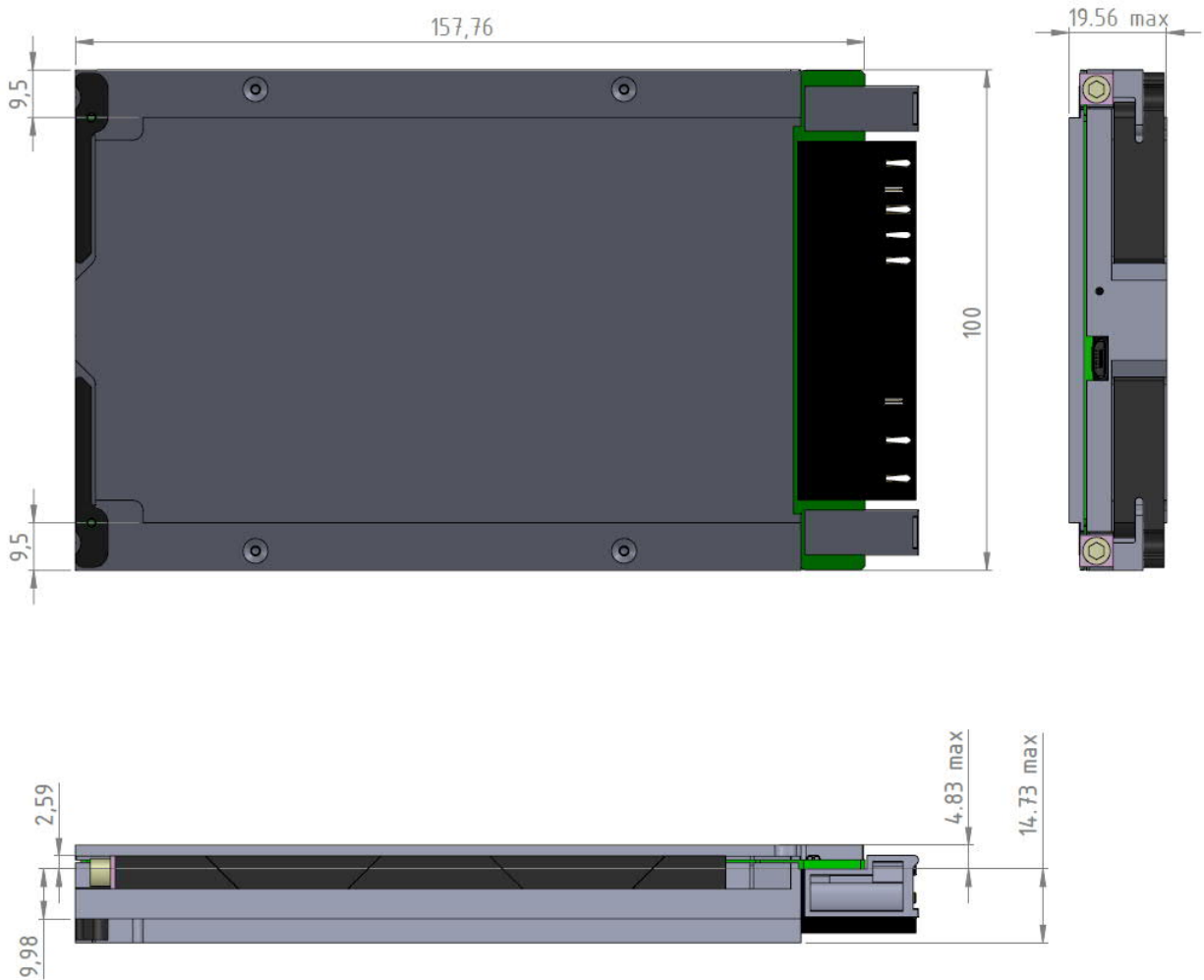

NOTICE: VPX340DMA is a VITA 62 "0.80 PITCH 3U CONDUCTION COOLED PLUG-IN MODULE". See VITA 62 FIGURE A-2 "3U Conduction Cooled Module Layout" for additional mechanical details.

4 I2C Documentation Version 1.2 (A7.x Boards)

4.1 Device Setup

- 7-Bit Addressing
- Slave Mode
- Address Auto Increment

4.2 I2C Device Address Byte

Accessing the device requires an 8-bit Device Address word following a Start condition to enable the device for a Read or Write operation. Since multiple slave devices can reside on the serial bus, each slave device must have its own unique address so the Master can access each device independently. The most significant four bits of the Device Address word is referred to as the device type identifier. The device type identifier '11001' is required in bits seven through three of the Device Address byte. Following the 2-bit Hardware Slave Address Bits GA1* (Pin B5) and GA0* (Pin A5). GA1* and GA0 both have an internal pull-up resistor of 10k to VCC.

A HIGH level on these pins gives a "0" on the GA pin.

A LOW level on these pins gives a "1" on the GA pin.

Device Type Identifier					Hardware Slave Address Bits		Read / Write
Bit 7	Bit 6	Bit 5	Bit 4	Bit 3	Bit 2	Bit 1	Bit 0
1	1	0	0	1	GA1	GA0	R/ \bar{W}

4.3 Device Access

Reading the device requires a write to the desired memory address of the Slave Device followed by a Read. Since ADC Data has 16-bit values, ADC values are split in high and low bytes. The address pointer will automatically increase after one read cycle.

4.3.1 A Typical Slave I2C™ Message: Multiprocessor Command/Status

Note: This example uses 10-Bit Address instead of 7-Bit Address

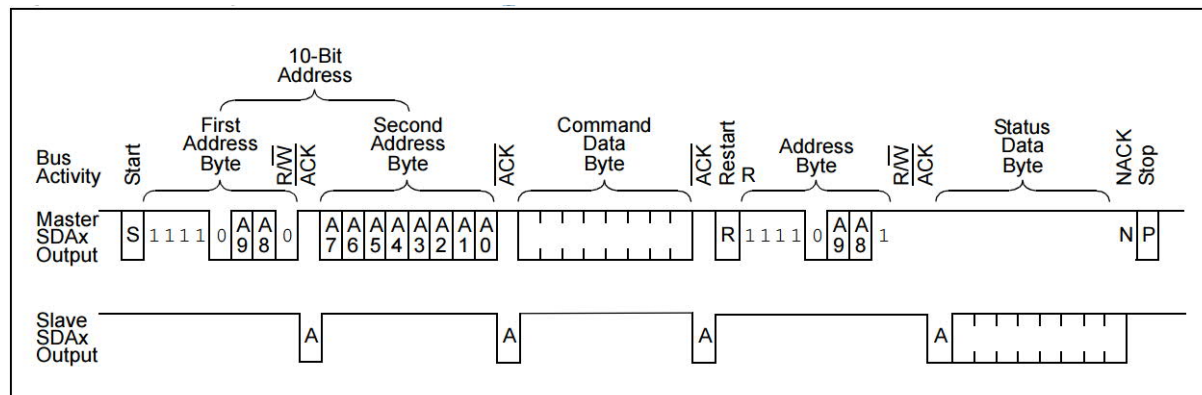

- All status bits are high active.

- Data size per address is 1 Byte
- All Registers are read only
- Module description :
 - o Module0: PO1:12VP (12V Main Power)
 - o Module1: PO3:5V (5V Main Power)
 - o Module2: PO2:3V3 (3.3V Main Power)
 - o Module3: VIN (Input Voltage)
 - o Module4: 12VN AUX (-12V Auxiliary Voltage)
 - o Module5: 3V3 Aux (3.3V Auxiliary Voltage)
 - o Module6: 12VP Aux (+12V Auxiliary Voltage)
- All data is stored in Little Endian order

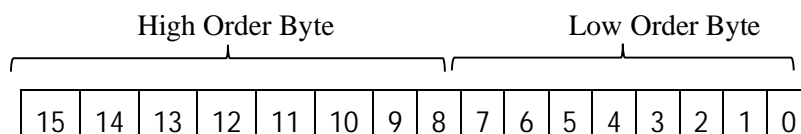

- o 16 Bit DataValue = [[High Byte][Low Byte]]

Command Data Byte	Register Name	Type	Description
0x00	PS Global Status Low Byte (Bit field)	uint8_t (Bit field)	B0: PO On
0x01	PS Global Status High Byte (Bit field)		B1: AUX On B2: Global Failure B3-B7: Reserved B8-B15: Reserved
0x02	Reserved		
0x03	Reserved		
0x04	Module 0 Status Low Byte (Bit field)	uint8_t (Bit field)	B0: Is On
0x05	Module 0 Status High Byte (Bit field)		B1: Overvoltage B2: Undervoltage B3: Overcurrent B4: Overtemperature B5-B15: Reserved
0x06	Module 0 Output Voltage Low Byte	int16_t	Calculation in [V]: $U0 = \text{DataValue} / (2^{11})$
0x07	Module 0 Output Voltage High Byte		
0x08	Module 0 Output Current Low Byte	int16_t	Calculation in [A]: $I0 = \text{DataValue} / (2^8)$
0x09	Module 0 Output Current High Byte		

0x0A	Module 0 Temperature Low Byte	int16_t	T0 is 16bit signed integer in degree
0x0B	Module 0 Temperature High Byte		
0x0C	Module 1 Status Low Byte (Bit field)	uint8_t (Bit field)	B0: Is On B1: Overvoltage B2: Undervoltage B3: Overcurrent B4: Overtemperature B5-B15: Reserved
0x0D	Module 1 Status High Byte (Bit field)		
0x0E	Module 1 Output Voltage Low Byte	int16_t	Calculation in [V]: $U1 = \text{DataValue} / (2^{12})$
0x0F	Module 1 Output Voltage High Byte		
0x10	Module 1 Output Current Low Byte	int16_t	Calculation in [A]: $I1 = \text{DataValue} / (2^8)$
0x11	Module 1 Output Current High Byte		
0x12	Module 1 Temperature Low Byte	int16_t	T1 is 16bit signed integer in degree
0x13	Module 1 Temperature High Byte		
0x14	Module 2 Status Low Byte (Bit field)	uint8_t (Bit field)	B0: Is On B1: Overvoltage B2: Undervoltage B3: Overcurrent B4: Overtemperature B5-B15: Reserved
0x15	Module 2 Status High Byte (Bit field)		
0x16	Module 2 Output Voltage Low Byte	int16_t	Calculation in [V]: $U2 = \text{DataValue} / (2^{12})$
0x17	Module 2 Output Voltage High Byte		
0x18	Module 2 Output Current Low Byte	int16_t	Calculation in [A]: $I2 = \text{DataValue} / (2^9)$
0x19	Module 2 Output Current High Byte		
0x1A	Module 2 Temperature Low Byte	int16_t	Reserved
0x1B	Module 2 Temperature High Byte		
0x1C	Module 3 Status Low Byte (Bit field)	uint8_t (Bit field)	B0: Is On B1: Overvoltage B2: Undervoltage B3: Overcurrent B4: Overtemperature B5-B15: Reserved
0x1D	Module 3 Status High Byte (Bit field)		
0x1E	Module 3 Output Voltage Low Byte	int16_t	Calculation in [V]: $U3 = \text{DataValue} / (2^8)$
0x1F	Module 3 Output Voltage High Byte		

0x20	Module 3 Output Current Low Byte	int16_t	Calculation in [A]: $I3 = \text{DataValue} / (2^9)$
0x21	Module 3 Output Current High Byte		
0x22	Module 3 Temperature Low Byte	int16_t	Reserved
0x23	Module 3 Temperature High Byte		
0x24	Module 4 Status Low Byte (Bit field)	uint8_t (Bit field)	B0: Is On B1: Overvoltage B2: Undervoltage B3: Overcurrent B4: Overtemperature B5-B15: Reserved
0x25	Module 4 Status High Byte (Bit field)		
0x26	Module 4 Output Voltage Low Byte	int16_t	Calculation in [V]: $U4 = \text{DataValue} / (2^{10})$
0x27	Module 4 Output Voltage High Byte		
0x28	Module 4 Output Current Low Byte	int16_t	Calculation in [A]: $I4 = \text{DataValue} / (2^{12})$
0x29	Module 4 Output Current High Byte		
0x2A	Module 4 Temperature Low Byte	int16_t	Reserved
0x2B	Module 4 Temperature High Byte		
0x2C	Module 5 Status Low Byte (Bit field)	uint8_t (Bit field)	B0: Is On B1: Overvoltage B2: Undervoltage B3: Overcurrent B4: Overtemperature B5-B15: Reserved
0x2D	Module 5 Status High Byte (Bit field)		
0x2E	Module 5 Output Voltage Low Byte	int16_t	Calculation in [V]: $U5 = \text{DataValue} / (2^{12})$
0x2F	Module 5 Output Voltage High Byte		
0x30	Module 5 Output Current Low Byte	int16_t	Calculation in [A]: $I5 = \text{DataValue} / (2^{11})$
0x31	Module 5 Output Current High Byte		
0x32	Module 5 Temperature Low Byte	int16_t	Reserved
0x33	Module 5 Temperature High Byte		
0x34	Module 6 Status Low Byte (Bit field)	uint8_t (Bit field)	B0: Is On B1: Overvoltage B2: Undervoltage B3: Overcurrent B4: Overtemperature B5-B15: Reserved
0x35	Module 6 Status High Byte (Bit field)		

0x36	Module 6 Output Voltage Low Byte	int16_t	Calculation in [V]: $U_6 = \text{DataValue} / (2^{11})$
0x37	Module 6 Output Voltage High Byte		
0x38	Module 6 Output Current Low Byte	int16_t	Calculation in [A]: $I_6 = \text{DataValue} / (2^{12})$
0x39	Module 6 Output Current High Byte		
0x3A	Module 6 Temperature Low Byte	int16_t	Reserved
0x3B	Module 6 Temperature High Byte		

4.4 Timing

4.4.1 I²C™ BUS START/STOP BITS TIMING CHARACTERISTICS (SLAVE MODE)

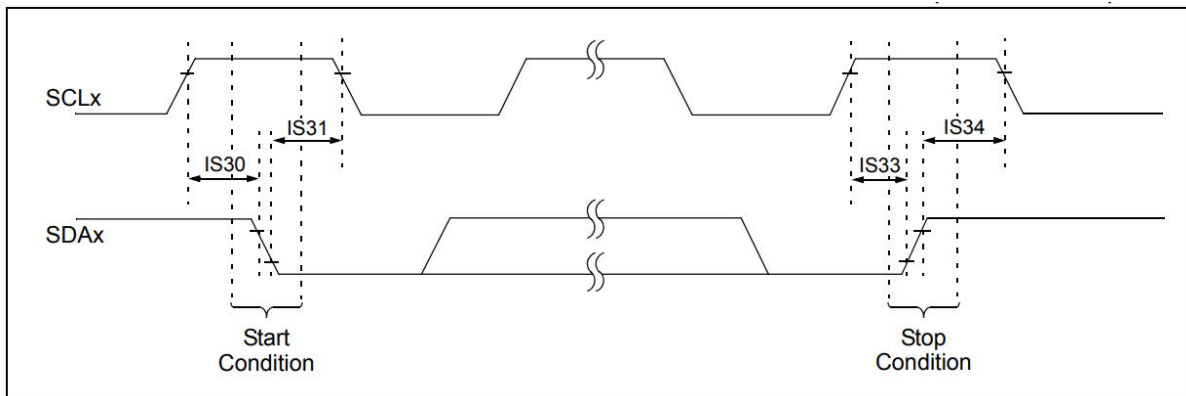

4.4.2 I²C™ BUS DATA TIMING CHARACTERISTICS (SLAVE MODE)

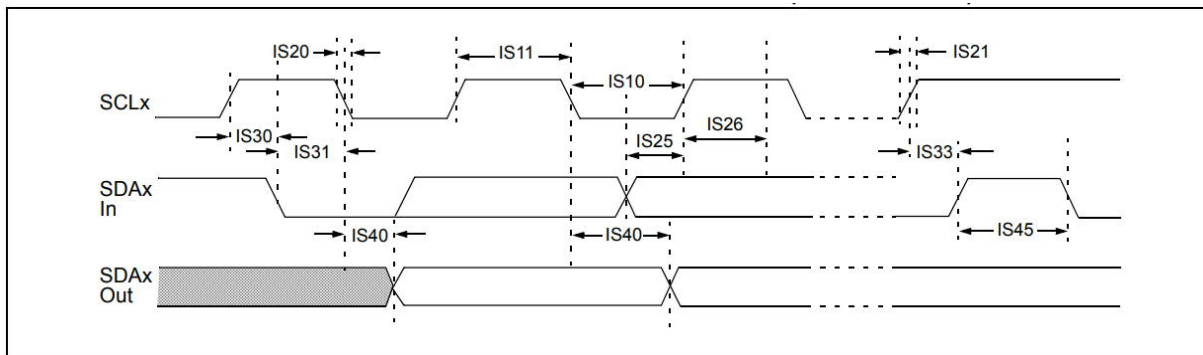

4.4.3 I2C™ BUS DATA TIMING REQUIREMENTS (SLAVE MODE)

These parameters are characterized, but not tested in manufacturing.

AC CHARACTERISTICS		Standard Operating Conditions: 3.0V to 3.6V (unless otherwise stated) Operating temperature: -40°C ≤ TA ≤ +85°C for Industrial -40°C ≤ TA ≤ +125°C for Extended					
Param No.	Symbol	Characteristic	Min	Max	Units	Conditions	
IS10	TLO:SCL	Clock Low Time	100 kHz mode	4.7	-	μs	
			400 kHz mode	1.3	-	μs	
IS11	THI:SCL	Clock High Time	100 kHz mode	4.0	-	μs	
			400 kHz mode	0.6	-	μs	
IS20	TF:SCL	SDA and SCL Fall Time	100 kHz mode	-	300	ns	CB is specified to be from 10 to 400pF
			400 kHz mode	20 + 0.1 CB	300	ns	
IS21	TR:SCL	SDA and SCL Rise Time	100 kHz mode	-	1000	ns	CB is specified to be from 10 to 400pF
			400 kHz mode	20 + 0.1 CB	300	ns	
IS25	TSU:DAT	Data Input Setup Time	100 kHz mode	250	-	ns	
			400 kHz mode	100	-	ns	
IS26	THD:DAT	Data Input Hold Time	100 kHz mode	0	-	ns	
			400 kHz mode	0	0.9	μs	
IS30	TSU:STA	Start Condition Setup Time	100 kHz mode	4.7	-	μs	Only relevant for Repeated Start condition
			400 kHz mode	0.6	-	μs	
IS31	THD:STA	Start Condition Hold Time	100 kHz mode	4.0	-	μs	After this period, the first clock pulse is generated
			400 kHz mode	0.6	-	μs	
IS33	TSU:STO	Stop Condition Setup Time	100 kHz mode	4.7	-	μs	
			400 kHz mode	0.6	-	μs	
IS34	THD:STO	Stop Condition Hold Time	100 kHz mode	4	-	μs	
			400 kHz mode	0.6	-	μs	
IS40	TAA:SCL	Output Valid From Clock	100 kHz mode	0	3500	ns	
			400 kHz mode	0	1000	ns	
IS45	TBF:SDA	Bus Free Time	100 kHz mode	4.7	-	μs	Time the bus must be free before a new transmission can start
			400 kHz mode	1.3	-	μs	

IS50	CB	Bus Capacitive Loading		-	400	pF	
IS51	TPGD	Pulse Gobbler Delay		65	390	ns	The typical value for this parameter is 130 ns.

4.5 User Software

MS Windows program with GUI to monitor and control VPX340DMA power supply via USB or I2C Note: USB device driver or I2C interface (e.g. Microchip ADM00559) are required.

Features include:

- Global status
- Remote On / Off
- DC-IN status and measured voltage and current
- 2 internal Temperatures
- Voltage, current and status of individual output power modules (all channels)
- Calibration / setup and diagnostics

Download VPX Tool 2.0.xxxx from <http://file.wiener-d.com/software/VPX/>

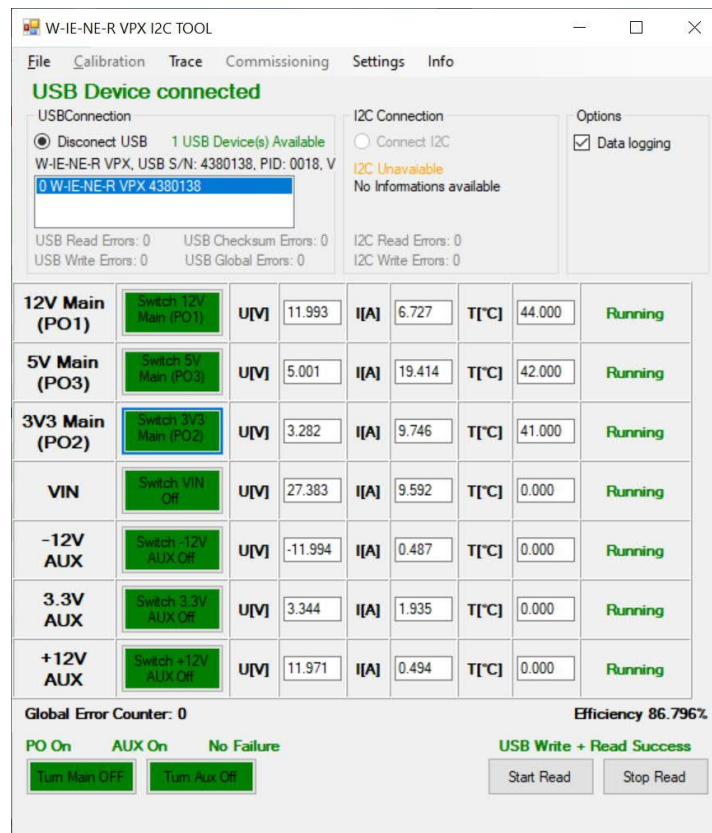

Module	Switch	Unit	V [V]	I [A]	T [°C]	Temp [°C]	Status
12V Main (PO1)	Switch 12V Main (PO1)	U[V]	11.993	6.727	T[°C]	44.000	Running
5V Main (PO3)	Switch 5V Main (PO3)	U[V]	5.001	19.414	T[°C]	42.000	Running
3V3 Main (PO2)	Switch 3V3 Main (PO2)	U[V]	3.282	9.746	T[°C]	41.000	Running
VIN	Switch VIN Off	U[V]	27.383	9.592	T[°C]	0.000	Running
-12V AUX	Switch -12V AUX Off	U[V]	-11.994	0.487	T[°C]	0.000	Running
3.3V AUX	Switch 3.3V AUX Off	U[V]	3.344	1.935	T[°C]	0.000	Running
+12V AUX	Switch +12V AUX Off	U[V]	11.971	0.494	T[°C]	0.000	Running