

Data sheet | Item number: 756-3202/120-100

Connecting cable; 12-pole; Length: 10 m

www.wago.com/756-3202/120-100

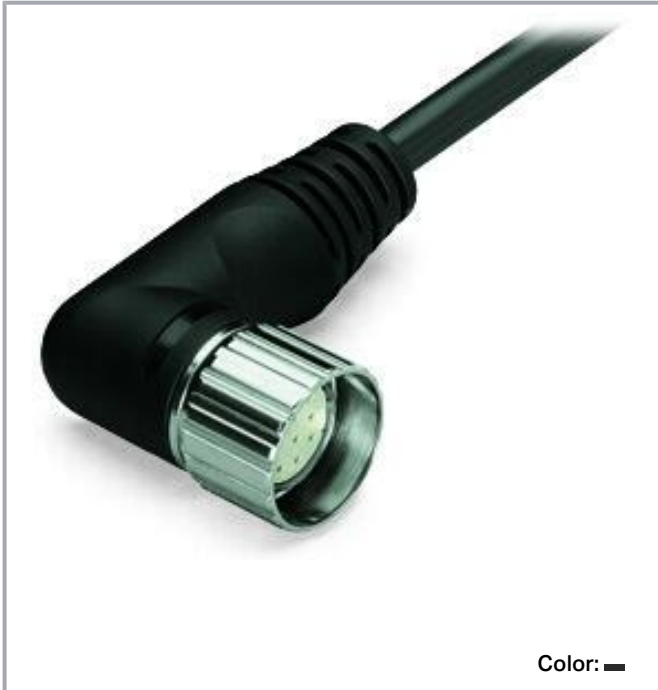

Color: ■

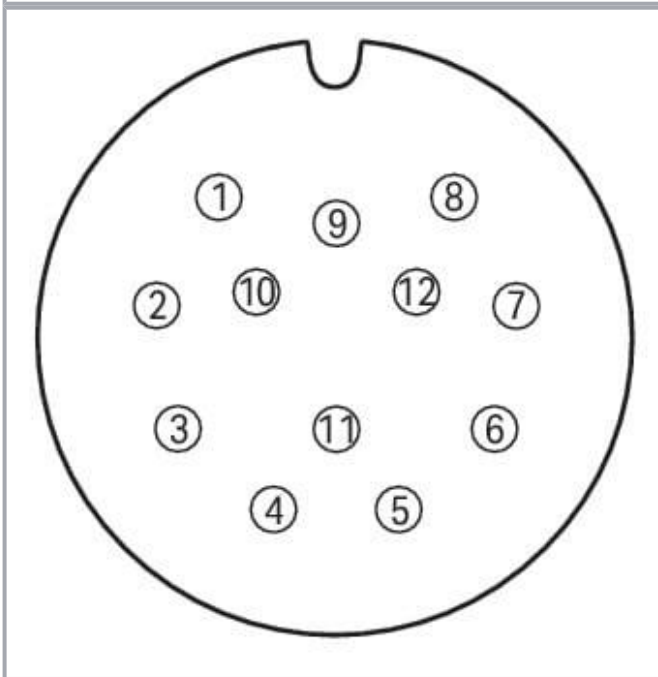
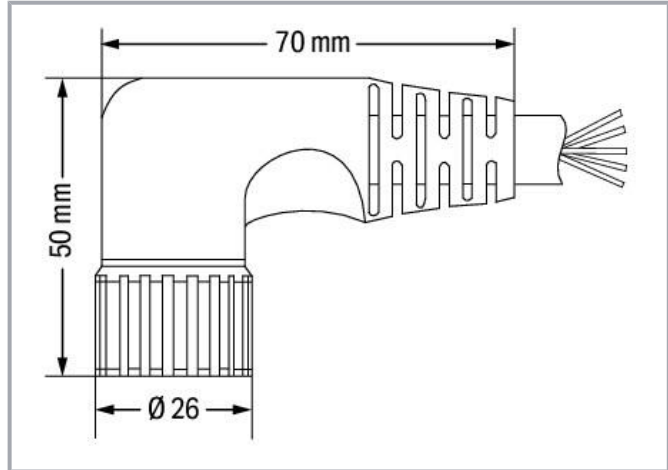

Pin 9, 11, 12: 1.00 mm²;
Pin 1 - 8: 0.34 mm²

- | | |
|----------|--------------------|
| 1 white | 9 blue |
| 2 green | 10 commoned with 9 |
| 3 yellow | 11 brown |
| 4 gray | 12 green/yellow |
| 5 pink | |
| 6 red | |
| 7 black | |
| 8 violet | |

Subject to changes. Please also observe the further product documentation!

WAGO GmbH & Co. KG

Hansastr. 27

32423 Minden

Phone: +49571 887-0 | Fax: +49571 887-169

Email: info.de@wago.com | Web: www.wago.com

Do you have any questions about our products?

We are always happy to take your call at +49 (571) 887-44222.



Data

Technical data

Connection type	M23 socket - free end
Pole number	12
Cable connection direction to mating direction	90 °
Cable length	10 m
Operating voltage	≤ 300 V
Operating current	8 A
Rated surge voltage	≥ 2.0 kV rms

Mechanical Data

Bending cycles	2 Mio.
Drag chain capability	yes
Sheathed cable diameter	9 ... 9.6 mm
Weight	1081 g
Color	black

Environmental requirements

Ambient (operating) temperature (dynamic)	-25 ... +80 °C
Ambient (operating) temperature (static)	-40 ... +80 °C
Protection type	IP67

Commercial data

Product Group	23 (I/O passive and accessories)
eCl@ss 10.0	27-06-03-11
eCl@ss 9.0	27-06-03-11
ETIM 8.0	EC001855
ETIM 7.0	EC001855
PU (SPU)	1 pcs
Packaging type	box
Country of origin	DE
GTIN	4044918569019
Customs tariff number	85444290900

Subject to changes. Please also observe the further product documentation!

WAGO GmbH & Co. KG
 Hansastr. 27
 32423 Minden
 Phone: +49571 887-0 | Fax: +49571 887-169
 Email: info.de@wago.com | Web: www.wago.com

Do you have any questions about our products?
 We are always happy to take your call at +49 (571) 887-44222.



Environmental Product Compliance

RoHS Compliance Status

Compliant, No Exemption

Downloads

Documentation

System Description

Sensor/Actuator Boxes – General Product Information

pdf
438.6 kB

[Download](#)

CAD/CAE-Data

CAE data

WSCAD Universe 756-3202/120-100

[URL](#)

[Download](#)

WSCAD Universe 756-3202/120-100

[URL](#)

[Download](#)

Environmental Product Compliance

Compliance Search

Environmental Product Compliance 756-3202/120-100

[URL](#)

[Download](#)

Connecting cable; 12-pole; Length: 10 m

Installation Notes

Subject to changes. Please also observe the further product documentation!

WAGO GmbH & Co. KG

Hansastr. 27

32423 Minden

Phone: +49571 887-0 | Fax: +49571 887-169

Email: info.de@wago.com | Web: www.wago.com

Do you have any questions about our products?

We are always happy to take your call at +49 (571) 887-44222.