

REVISIONS				
REV.	ECO. NO	DESCRIPTION	DATE	BY
D	3744	ADD REF CONTACT GAP, UPDATE SPEC FORMAT	9/28/2017	JT

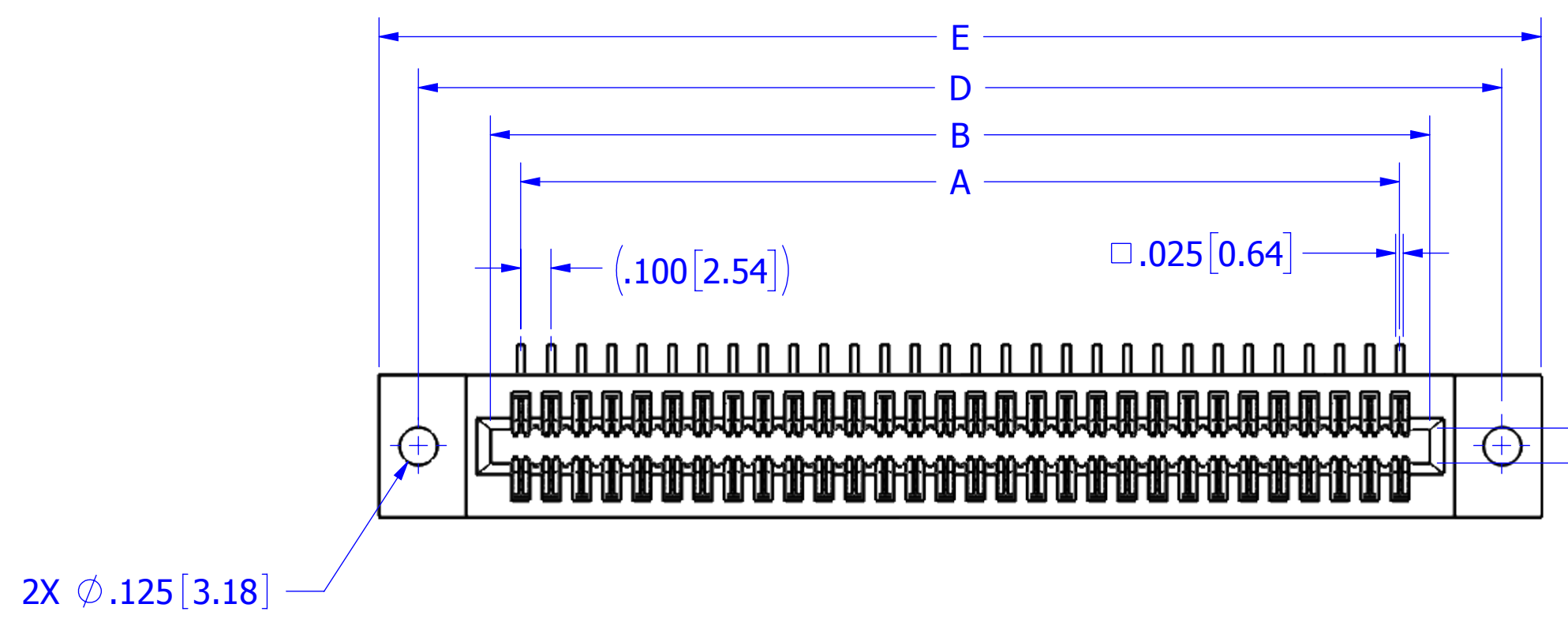

(.100[2.54]/.115[2.92] FOR S273)  
 (.135[3.43] FOR S664)  
 SEE NOTE 13

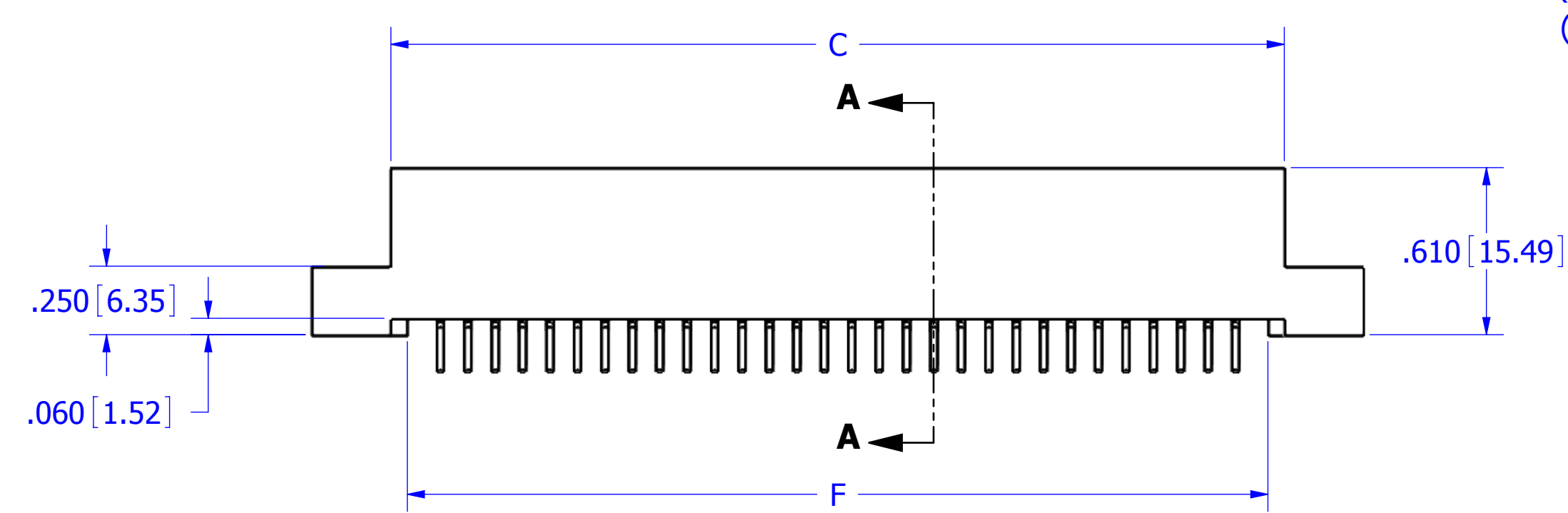

--- C --- DTAD - S  
 --- C --- DTBD - S  
 --- C --- DTMD - S

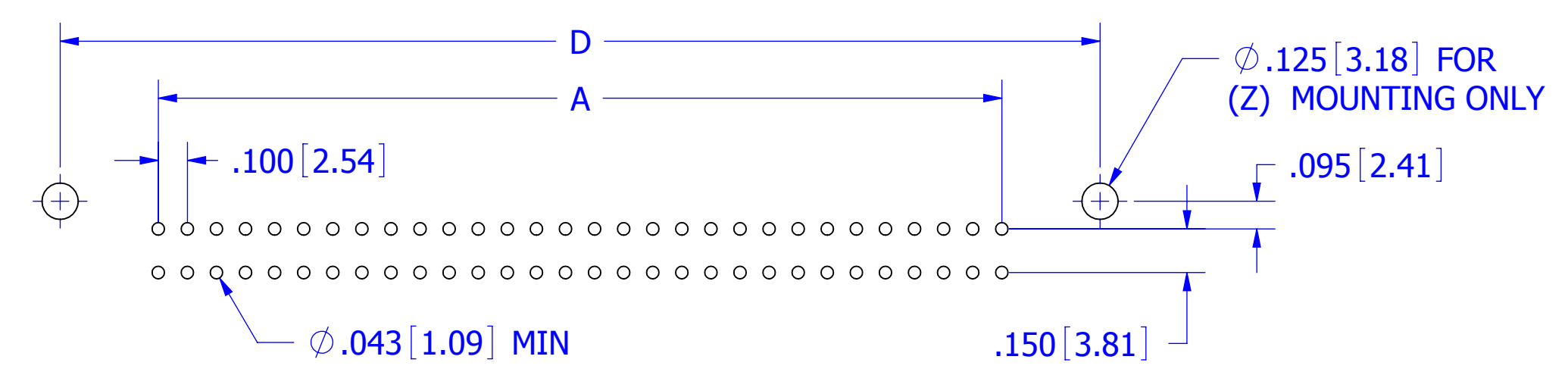
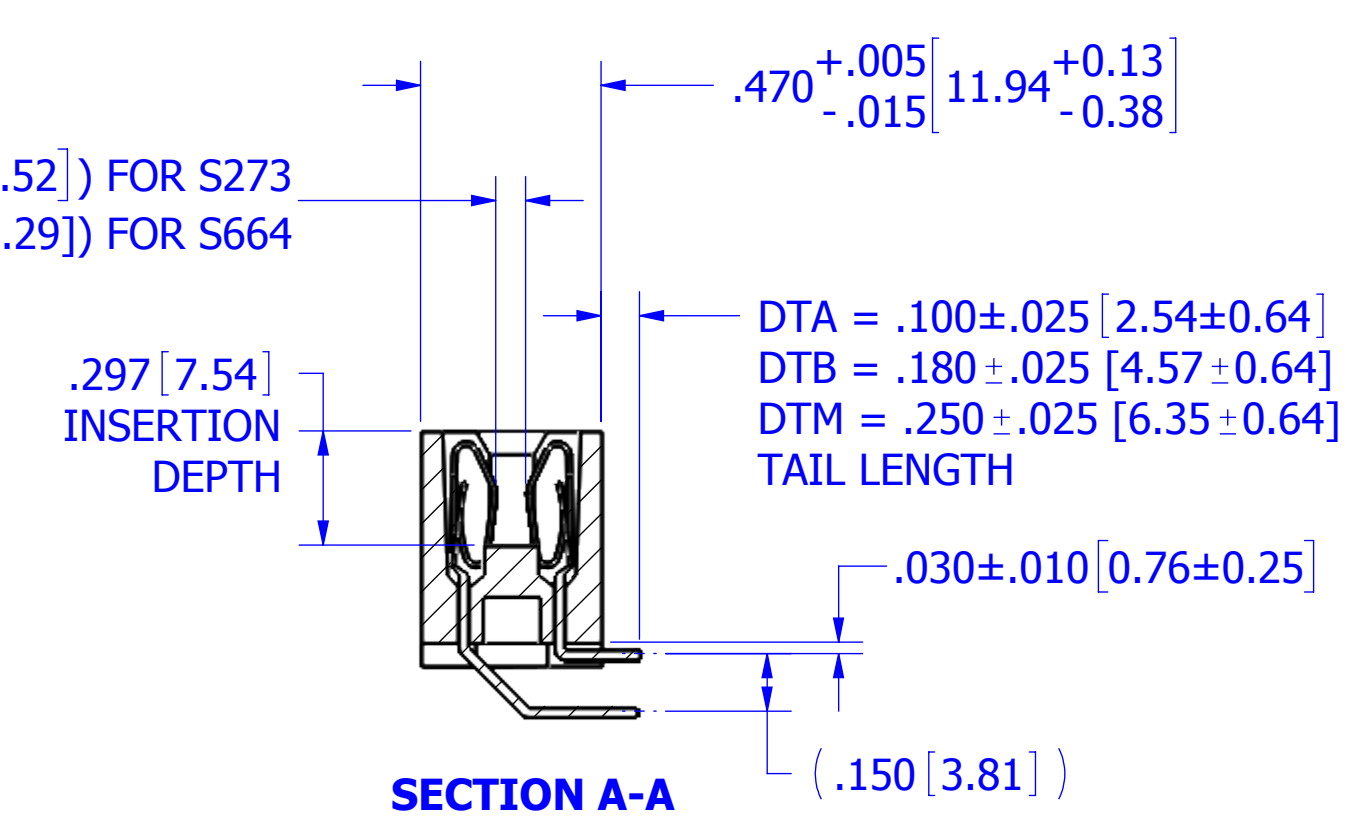

- NOTES:
1. INSULATOR MATERIAL: SEE PART NUMBER CODING
  2. CONTACT MATERIAL: SEE PART NUMBER CODING
  3. PLATING: SEE PART NUMBER CODING
  4. OPERATING TEMPERATURE: SEE PART NUMBER CODING
  5. PROCESSING TEMP: SEE PART NUMBER CODING
  6. UL FLAMMABILITY RATING: 94V-0
  7. OPERATING VOLTAGE: 700 VAC
  8. CURRENT RATING: 3 AMP
  9. CONTACT RESISTANCE: 30 MILLI OHMS MAX
  10. INSULATION RESISTANCE: 5000 MEGA OHMS
  11. DURABILITY: 500 CYCLES MINIMUM
  12. CONNECTOR IDENTIFICATION: THE PART SHALL BE MARKED WITH A PART NUMBER AND LOT CODE
  13. BOARD THICKNESS ACCOMMODATED: SEE PART NUMBER CODING
  14. INSERTION FORCE: S273 = 16 OZ MAX PER CONTACT PAIR WHEN USING A .093[2.36] TEST BLADE.  
S664 = 16 OZ MAX PER CONTACT PAIR WHEN USING A .125[3.18] TEST BLADE.  
INTERNAL INSPECTION TO BE PER SULLIN'S WORK INSTRUCTION W17.3-01.
  15. WITHDRAWAL FORCE: S273 = 1 ONCE MINIMUM PER CONTACT PAIR USING .093[2.36] TEST BLADE.  
S664 = 1 ONCE MINIMUM PER CONTACT PAIR USING .125[3.18] TEST BLADE.
  16. MODIFICATION: S273 = HIGH PROFILE CONNECTOR FOR .093 ± .008[2.36 ± 0.20] PCB.  
S664 = HIGH PROFILE CONNECTOR FOR .125 ± .008[3.18 ± 0.20] PCB.

**CUSTOMER COPY**



UNLESS OTHERWISE SPECIFIED: DIMENSIONS ARE IN INCHES [MM]	DRAWN	DATE	NAME	
		06/09/06	MV	
TOLERANCES: ANGULAR: ± 1° DECIMALS .XX = ± .02 [.5] .XXX = ± .005 [.13] .XXXX = ± .0005 [.013]	<small>THE INFORMATION HEREIN CONTAINS PROPRIETARY INFORMATION OF SULLINS ELECTRONICS AND IS NOT TO BE REPRODUCED, USED OR DISCLOSED TO OTHERS FOR ANY PURPOSE EXCEPT AS SPECIFICALLY AUTHORIZED IN WRITING BY AN OFFICER OF SULLINS ELECTRONICS.</small>			<b>TITLE</b> EDGECARD, .100 CC, .093 & .125 PCB
	<b>PART NUMBER</b> _ _ C _ _ DTA(DTB, DTM) _ - S273, S664			
	SIZE	CAGE CODE	DWG. NO.	
	C	54453	C10748	
	SCALE: 2:1	SHEET 1 OF 3		

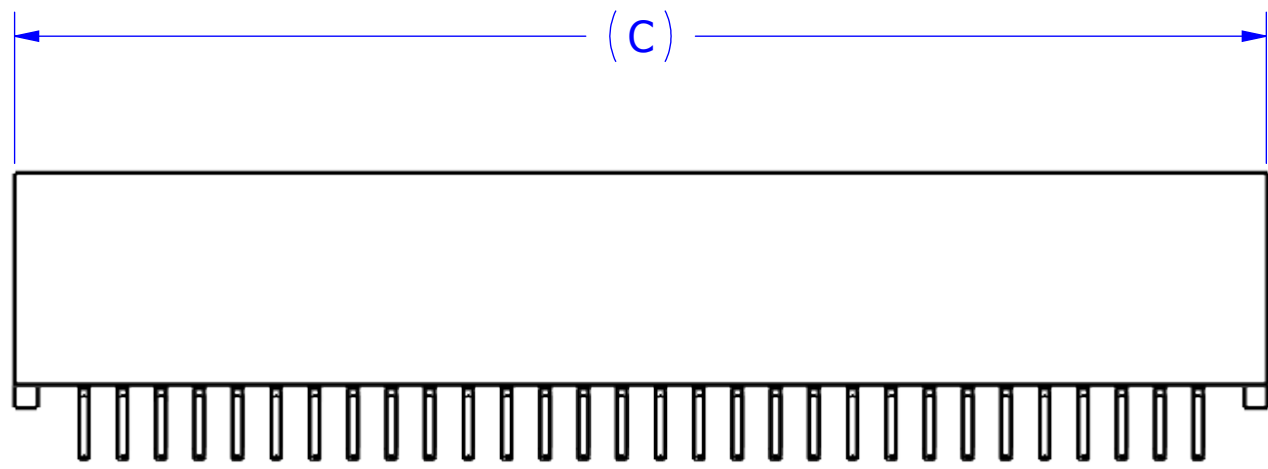
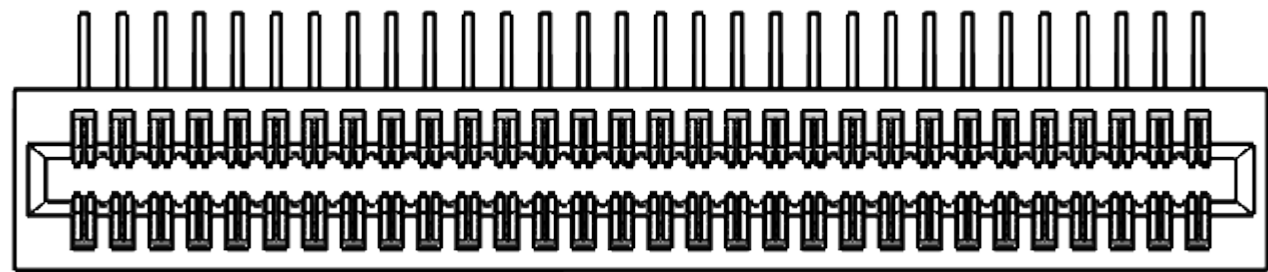

--- C --- DTAN - S ---  
 --- C --- DTBN - S ---  
 --- C --- DTMN - S ---

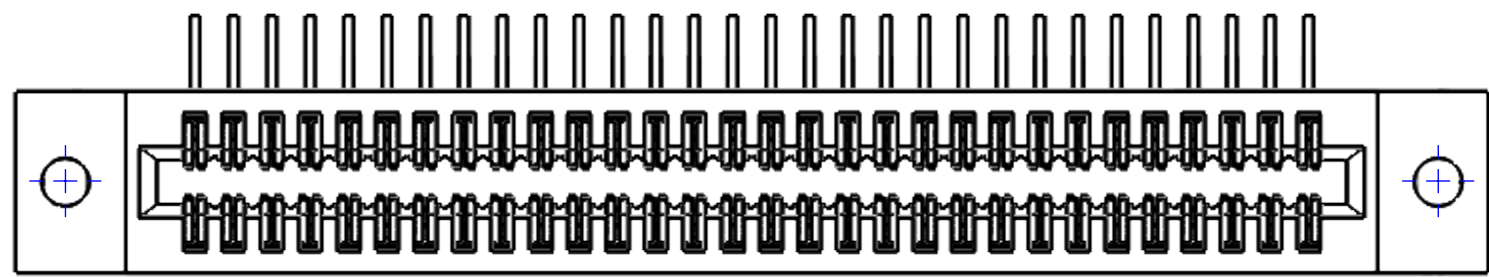

2X #4-40  
 THREADED  
 INSERTS

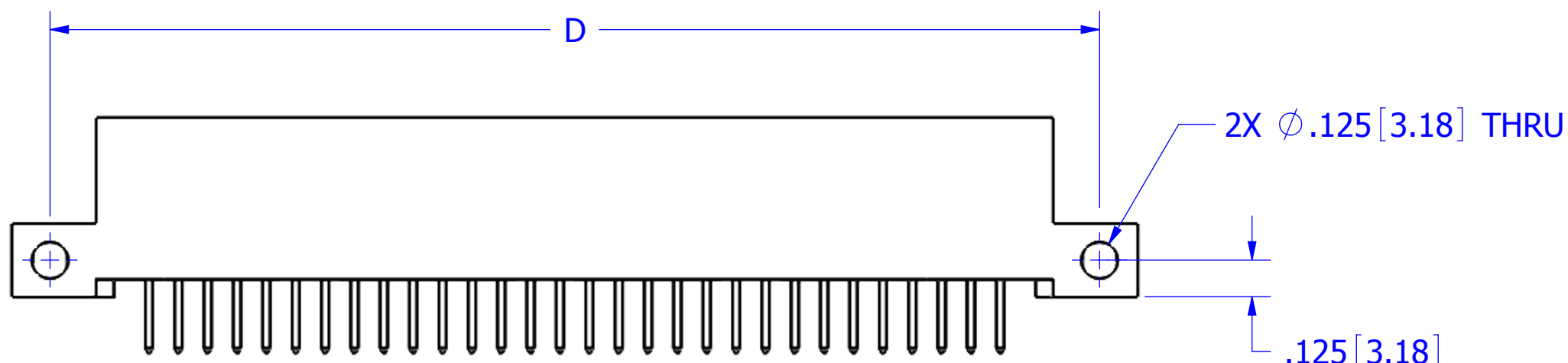
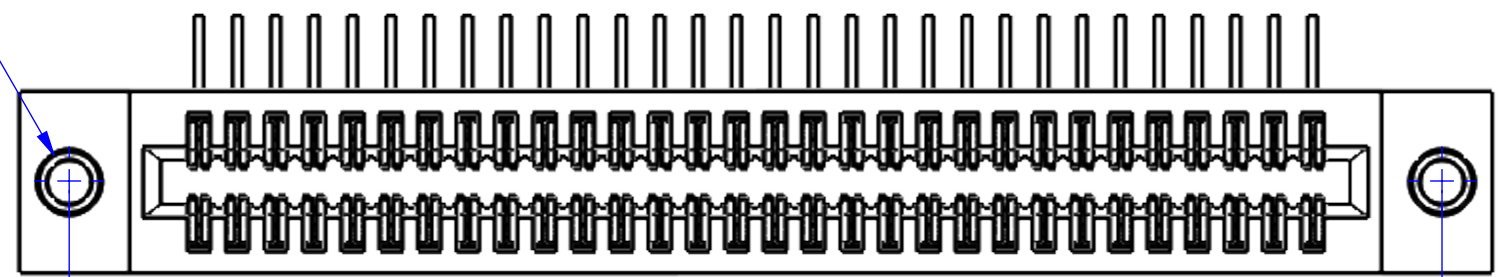

--- C --- DTAZ - S ---  
 --- C --- DTBZ - S ---  
 --- C --- DTMZ - S ---

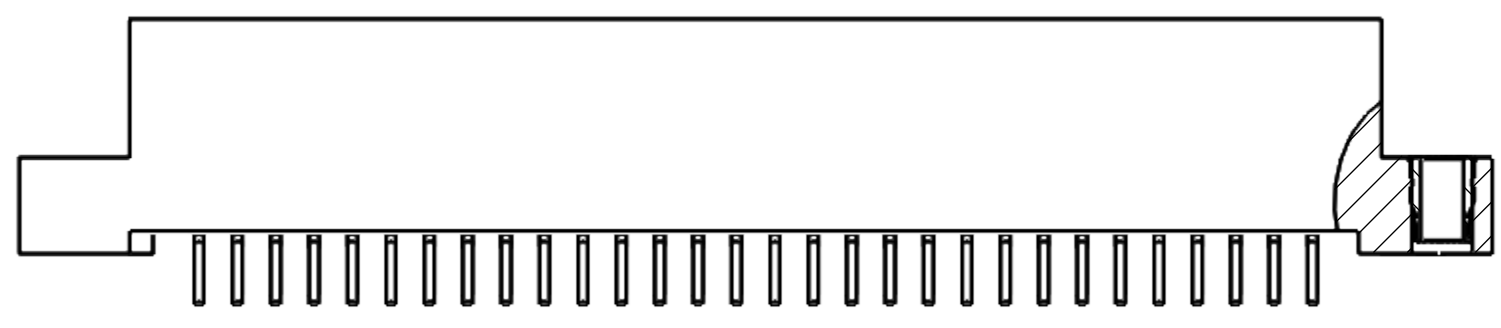

--- C --- DTAT - S ---  
 --- C --- DTBT - S ---  
 --- C --- DTM T - S ---

# CUSTOMER COPY



UNLESS OTHERWISE SPECIFIED:  
 DIMENSIONS ARE IN INCHES [MM]

TOLERANCES:  
 ANGULAR:  $\pm 1^\circ$   
 DECIMALS  
 .XX =  $\pm .02$  [.5]  
 .XXX =  $\pm .005$  [.13]  
 .XXXX =  $\pm .0005$  [.013]

DRAWN	DATE	NAME
	06/09/06	MV
<small>THE INFORMATION HEREIN CONTAINS PROPRIETARY INFORMATION OF SULLINS ELECTRONICS AND IS NOT TO BE REPRODUCED, USED OR DISCLOSED TO OTHERS FOR ANY PURPOSE EXCEPT AS SPECIFICALLY AUTHORIZED IN WRITING BY AN OFFICER OF SULLINS ELECTRONICS.</small>		

<b>SULLINS</b> CONNECTOR SOLUTIONS			
TITLE EDGE CARD, .100 CC, .093 & .125 PCB			
PART NUMBER C DTA(DTB, DTM) - S273, S664			
SIZE	CAGE CODE	DWG. NO.	REV
C	54453	C10748	D
SCALE: 2:1			SHEET 2 OF 3



PART NUMBER	NO. OF POS.	DIMENSIONS											
		A±.008[0.20]		B±.008[0.20]		C±.015[0.38]		D±.010[0.25]		E±.020[0.51]		F±.015[0.38]	
		IN	MM	IN	MM	IN	MM	IN	MM	IN	MM	IN	MM
C06D - S	6	0.500	12.70	0.700	17.78	0.860	21.84	1.175	29.85	1.435	36.45	0.750	19.05
C07D - S	7	0.600	15.24	0.800	20.32	0.960	24.38	1.275	32.39	1.535	38.99	0.850	21.59
C08D - S	8	0.700	17.78	0.900	22.86	1.060	26.92	1.375	34.93	1.635	41.53	0.950	24.13
C10D - S	10	0.900	22.86	1.100	27.94	1.260	32.00	1.575	40.01	1.835	46.61	1.150	29.21
C12D - S	12	1.100	27.94	1.300	33.02	1.460	37.08	1.775	45.09	2.035	51.69	1.350	34.29
C15D - S	15	1.400	35.56	1.600	40.64	1.760	44.70	2.075	52.71	2.335	59.31	1.650	41.91
C17D - S	17	1.600	40.64	1.800	45.72	1.960	49.78	2.275	57.79	2.535	64.39	1.850	46.99
C18D - S	18	1.700	43.18	1.900	48.26	2.060	52.32	2.375	60.33	2.635	66.93	1.950	49.53
C20D - S	20	1.900	48.26	2.100	53.34	2.260	57.40	2.575	65.41	2.835	72.01	2.150	54.61
C22D - S	22	2.100	53.34	2.300	58.42	2.460	62.48	2.775	70.49	3.035	77.09	2.350	59.69
C24D - S	24	2.300	58.42	2.500	63.50	2.660	67.56	2.975	75.57	3.235	82.17	2.550	64.77
C25D - S	25	2.400	60.96	2.600	66.04	2.760	70.10	3.075	78.11	3.335	84.71	2.650	67.31
C28D - S	28	2.700	68.58	2.900	73.66	3.060	77.72	3.375	85.73	3.635	92.33	2.950	74.93
C30D - S	30	2.900	73.66	3.100	78.74	3.260	82.80	3.575	90.81	3.835	97.41	3.150	80.01
C31D - S	31	3.000	76.20	3.200	81.28	3.360	85.34	3.675	93.35	3.935	99.95	3.250	82.55
C35D - S	35	3.400	86.36	3.600	91.44	3.760	95.50	4.075	103.51	4.335	110.11	3.650	92.71
C36D - S	36	3.500	88.90	3.700	93.98	3.860	98.04	4.175	106.05	4.435	112.65	3.750	95.25
C40D - S	40	3.900	99.06	4.100	104.14	4.260	108.20	4.575	116.21	4.835	122.81	4.150	105.41
C43D - S	43	4.200	106.68	4.400	111.76	4.560	115.82	4.875	123.83	5.135	130.43	4.450	113.03
C44D - S	44	4.300	109.22	4.500	114.30	4.660	118.36	4.975	126.37	5.235	132.97	4.550	115.57
C49D - S	49	4.800	121.92	5.000	127.00	5.160	131.06	5.475	139.07	5.735	145.67	5.050	128.27
C50D - S	50	4.900	124.46	5.100	129.54	5.260	133.60	5.575	141.61	5.835	148.21	5.150	130.81
C55D - S	55	5.400	137.16	5.600	142.24	5.760	146.30	6.075	154.31	6.335	160.91	5.650	143.51
C60D - S	60	5.900	149.86	6.100	154.94	6.260	159.00	6.575	167.01	6.835	173.61	6.150	156.21
C61D - S	61	6.000	152.40	6.200	157.48	6.360	161.54	6.675	169.55	6.935	176.15	6.250	158.75
C65D - S	65	6.400	162.56	6.600	167.64	6.760	171.70	7.075	179.71	7.335	186.31	6.650	168.91
C70D - S	70	6.900	175.26	7.100	180.34	7.260	184.40	7.575	192.41	7.835	199.01	7.150	181.61

**PART NUMBER CODING**

**C** **D** **S**

**MATERIALS (INSULATOR / CONTACT)**

- E = BLUE PBT/PHOSPHOR BRONZE**  
OPERATING TEMP: -65°C TO +125°C  
PROCESSING TEMP: WAVE/MANUAL SOLDERING ONLY
- R = GREEN PPS/PHOSPHOR BRONZE**  
OPERATING TEMP: -65°C TO +125°C  
PROCESSING TEMP: 260°C MAX FOR 20 SECS
- G = BLACK PA9T/PHOSPHOR BRONZE**  
OPERATING TEMP: -65°C TO +125°C  
PROCESSING TEMP: 260°C MAX FOR 20 SECS
- H = BLUE PBT/BERYLLIUM COPPER**  
OPERATING TEMP: -65°C TO +125°C  
PROCESSING TEMP: WAVE/MANUAL SOLDERING ONLY
- A = GREEN PPS/BERYLLIUM COPPER**  
OPERATING TEMP: -65°C TO +150°C  
PROCESSING TEMP: 260°C MAX FOR 20 SECS
- J = BLACK PA9T/BERYLLIUM COPPER**  
OPERATING TEMP: -65°C TO +150°C  
PROCESSING TEMP: 260°C MAX FOR 20 SECS  
(CONSULT FACTORY FOR OTHER MATERIALS)

**MODIFICATION CODE**

- S273 = FOR .093±.008[2.36±0.20] THICK MATING PCB
- S664 = FOR .125±.008[3.18±0.20] THICK MATING PCB

**MOUNTING STYLE**

- N = NO MOUNTING EARS (PAGE 2)
- D = FLUSH MOUNTING (PAGE 1)
- T = FLUSH MOUNTING WITH # 4-40 THREADED INSERT (PAGE 2)
- Z = FLUSH MOUNTING WITH SIDE HOLES (PAGE 2)

**TERMINATION TYPE**

- TA = .100 [2.50] TAIL LENGTH
- TB = .180 [4.57] TAIL LENGTH
- TM = .250 [6.35] TAIL LENGTH  
(SEE SHEET 1, SECTION A-A)

**NUMBER OF POSITIONS (CONTACTS PER ROW)**

**PLATING**

ALL PLATINGS ARE LEAD FREE AND HAVE .000050" NICKEL UNDERPLATE

- |  |                          |
|--|--------------------------|
| CONTACT SURFACE  | TERMINATION              |
| G = .000010" GOLD  | .000005" GOLD            |
| Y = .000030" GOLD  | .000005" GOLD            |
| B = .000010" GOLD  | .000100" PURE TIN, MATTE |
| C = .000030" GOLD  | .000100" PURE TIN, MATTE |
| **E = .000100" PURE TIN, MATTE, OVERALL                    |                          |
| S = .000010" GOLD OVERALL                                  | .000010" GOLD OVERALL    |
| M = .000030" GOLD  |                          |
| ** OVERALL TIN ONLY AVAILABLE ON MATERIAL CODES E, R AND G |                          |

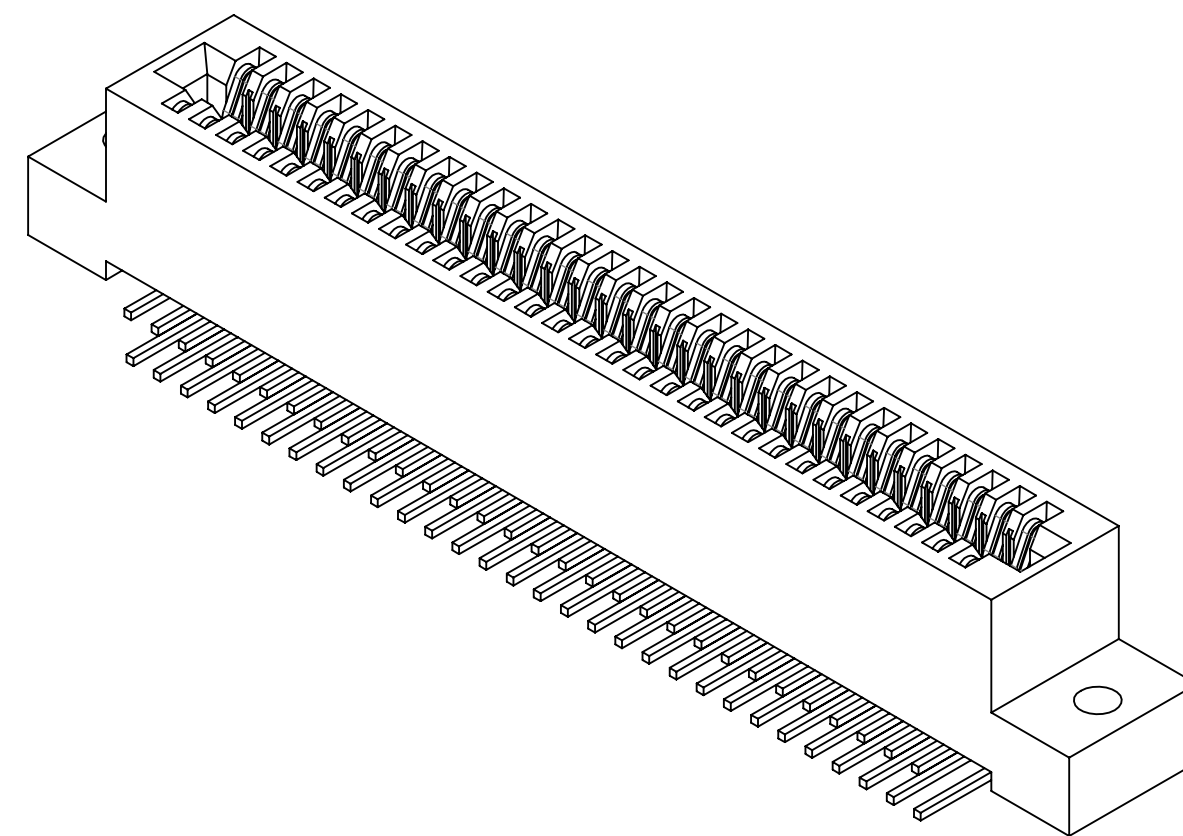

**CUSTOMER COPY**

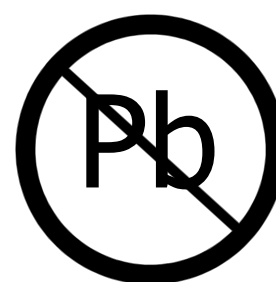

RoHS COMPLIANT

UNLESS OTHERWISE SPECIFIED: DIMENSIONS ARE IN INCHES [MM]		DRAWN	DATE	NAME	
			06/09/06	MV	
TOLERANCES: ANGULAR: ± 1° DECIMALS .XX = ± .02 [.5] .XXX = ± .005 [.13] .XXXX = ± .0005 [.013]					THE INFORMATION HEREIN CONTAINS PROPRIETARY INFORMATION OF SULLINS ELECTRONICS AND IS NOT TO BE REPRODUCED, USED OR DISCLOSED TO OTHERS FOR ANY PURPOSE EXCEPT AS SPECIFICALLY AUTHORIZED IN WRITING BY AN OFFICER OF SULLINS ELECTRONICS.
<b>EDGE CARD, .100 CC, .093 &amp; .125 PCB</b> <b>PART NUMBER</b> C DTA(DTB, DTM) - S273, S664					
SIZE	CAGE CODE	DWG. NO.	REV		
C	54453	C10748	D		
SCALE: 2:1			SHEET 3 OF 3		