

REVISIONS					
REV	ECO	DESCRIPTION	DATE	BY	APPR
A1	-	RELEASE DRAWING	24AUG/19	PETER	TOMMY

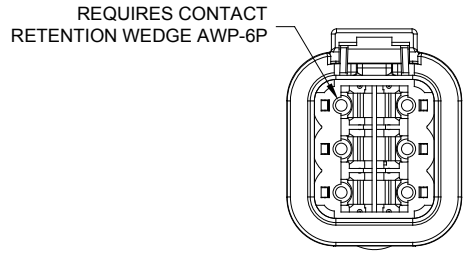

NOTES: UNLESS OTHERWISE SPECIFIED

- MATERIAL:  
HOUSING: THERMOPLASTIC  
SEAL: SILICONE RUBBER
- MODIFICATIONS: REDUCED DIAMETER WIRE SEAL
- SPECIFICATIONS:
  - CURRENT RATING: 25 AMPS
  - OPERATING TEMPERATURE: -55°C TO +125°C
  - DIELECTRIC WITHSTANDING VOLTAGE: LESS THAN 2 MILLIAMPS CURRENT LEAKAGE @ 1500 VOLTS AC.
  - INSULATION RESISTANCE: 1000 MEGOHMS MIN @ 25°C.
  - MOISTURE RESISTANCE: IP67 ( MATED CONDITION )
  - MATING CYCLE DURABILITY: 100 CYCLES
  - RoHS COMPLIANT
- MATING PART: ATP06-6S\* PLUG.  
(\* = MODIFICATIONS AND COLORS )
- ALL DIMENSIONS ARE FOR REFERENCE USE ONLY.

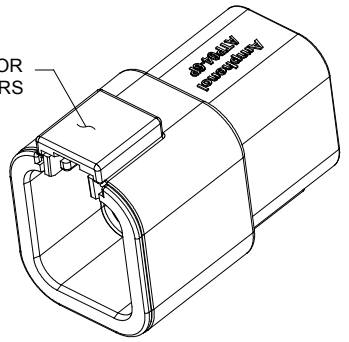
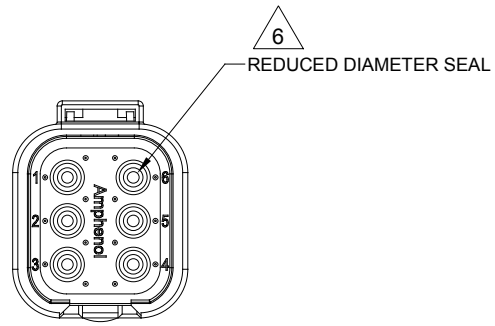
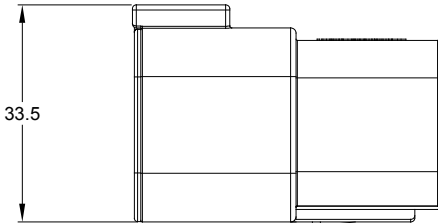
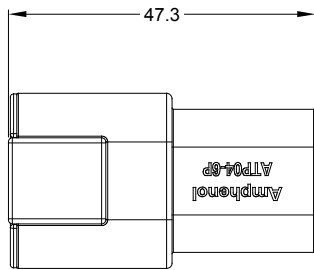
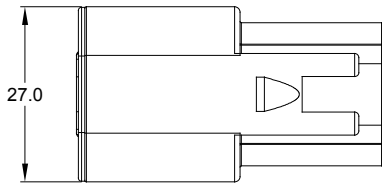

PART NUMBER CHART	
COLOR	PART NUMBER
GREY	ATP04-6P-RD01
BLACK	ATP04-6P-RD01BK

STANDARD MOLDED COLOR IS GREY. ADDITIONAL COLOR ( BLACK ) IS AVAILABLE VIA SPECIAL ORDER.

6 CONTACT SIZE AND REAR SEAL WIRE RANGE:

CONTACT SIZE	MIN. INSUL O.D.	MAX. INSUL O.D.	TYPICAL WIRE RANGE
12	2.46 mm (.097 in)	4.01 mm (.158 in)	12 - 14 AWG





SEE PART NUMBER CHART		PART NUMBER		DESCRIPTION		ITEM
QUANTITY	MATERIALS LIST					
UNLESS OTHERWISE SPECIFIED		SIGNATURES		DATE		
1) All dimensions are in metric (mm).		DRAWN:	PETER YANG	24AUG/19		
2) Tolerances are as follows:		CHECKED:	ORION LI	24/JUN/19		
1 PL DEC ±0.30		ENGINEER:				
2 PL DEC ±0.15		APPROVAL:		TOMMY XIE 24AUG/19		
3 PL DEC ±0.08		CUSTOMER:				
3) Note reference =		THIS DRAWING IS SUPPLIED FOR INFORMATION ONLY. DESIGN FEATURES, SPECIFICATIONS AND PERFORMANCE DATA SHOWN HEREON ARE THE PROPERTY OF THE AMPHENOL CORPORATION. NO RIGHTS OF REPRODUCTION ARE IMPLIED. ALL DIMENSIONS ARE SUBJECT TO NORMAL MANUFACTURING VARIATIONS.				
MATERIAL SPECIFICATIONS:		CUSTOMER:		SIZE		REVISION
PROCESS SPECIFICATIONS:		CUSTOMER:		TYPE		
NEXT ASSY:		CUSTOMER:		DWG NO:		
				ATP04-6P-RD01XX		A1
		SCALE		NONE		
				SHEET 1 OF 1		



TITLE: RECEPTACLE, 6 PIN, REDUCED DIAMETER SEAL, ATP SERIES  
DWG NO.: ATP04-6P-RD01XX  
REV: A1  
SH: 1  
OF: 1

# ATP Series™ - Contact Size 12 Options



Machined Contacts, Sockets & Pins				
Part Number	Description	Size	AWG	Type
AT60-204-12141-10	Male Contact - Pin, Nickel-plated	12	10-12	Machined
AT62-203-12141-10	Female Contact - Socket, Nickel-plated	12	10-12	Machined
AT60-220-1231	Male Contact - Pin, Gold-plated	12	12-14	Machined
AT62-210-1231	Female Contact - Socket, Gold-plated	12	12-14	Machined
AT60-204-12141	Male Contact - Pin, Nickel-plated	12	12-14	Machined
AT62-203-12141	Female Contact - Socket, Nickel-plated	12	12-14	Machined

DiagnosticGrade™ Machined Contacts, Sockets & Pins				
• Smaller AWG for Diagnostic Applications • Gold-plated • Increased Mating Cycles • Cost-effective				
Part Number	Description	Size	AWG	Type
65-54749	Male Contact - DiagnosticGrade™, Pin, Gold-plated	12	20	Machined
AT62-210-1231-1820	Female Contact - DiagnosticGrade™, Socket, Gold-plated	12	20	Machined

Tooling - Machined Contacts		
Part	Part Number	Description
	CA-5D12	Universal Hand Crimp Tool, Size 12/16/20 (Machined contacts only)
	CA-5E12	Pneumatic Crimp Tool, Size 12/16/20 (Machined contacts only)
	M300-25A	Hand Crimp Tool used with Crimp Locator MFX-3966, Size 12, 10AWG (Machined contacts only)
	MFX-3966	Contact Locator used with Hand Crimp Tool M300-25A, Size 12, 10AWG (Machined contacts only)

Contact Removal Tools		
Part	Part Number	Description
	ATRT-100	Used for removal of contacts for A Series™ products
	AT11-337-1205	Contact Removal Tool, Plastic, Size 12
	A114017	Sealing Plug, Size 12, White

Stamped & Formed Contacts, Sockets & Pins				
Part Number	Description	Size	AWG	Type
AT60-12-0244	Male Contact - Pin, Gold-plated	12	10-12	Stamped & Formed
AT62-12-0244	Female Contact - Socket, Gold-plated	12	10-12	Stamped & Formed
AT60-12-0222	Male Contact - Pin, Nickel-plated	12	10-12	Stamped & Formed
AT62-12-0222	Female Contact - Socket, Nickel-plated	12	10-12	Stamped & Formed
AT60-12-0144	Male Contact - Pin, Gold-plated	12	12-14	Stamped & Formed
AT62-12-0144	Female Contact - Socket, Gold-plated	12	12-14	Stamped & Formed
AT60-12-0166	Male Contact - Pin, Nickel-plated	12	12-14	Stamped & Formed
AT62-12-0166	Female Contact - Socket, Nickel-plated	12	12-14	Stamped & Formed

Tooling - Stamped & Formed Contacts		
Part	Part Number	Description
	MFX-3973	Crimp Die - Size 12 (S&F contacts only)
	MFX-3985	Crimp Die - Size 12 (S&F contacts only) 10-12AWG -02XX Series
	ATT-12-00	Hand Crimp Tool - Size 12, 12AWG (S&F contacts only)
	ATT-12-01	Hand Crimp Tool - Size 12, 10AWG (S&F contacts only)