

## COOL POWER TECHNOLOGIES

### Thirty-Second-Brick Isolated DC/DC Converter

#### Features

- DOSA standard 32<sup>nd</sup> brick footprint
- 0.92" X 0.76" x 0.35" tall (0.396" (10mm) SMT)
- Wide input voltage range: 18 – 36Vin
- Output: 5 V at 6 A, 30W max.
- ROHS 3 Directive 2015/863/EU compliant
- No minimum load/capacitance required
- On-board input differential "PI" LC-filter
- Basic Insulation w/1500VDC I/O isolation
- Withstands 50 V input transients
- Fixed-frequency operation
- Full protection (OTP, OCP, OVP, UVLO – auto-restart)
- Remote ON/OFF - positive or negative enable logic options
- Remote sense
- Output voltage trim range:  $\pm 10\%$  (industry-standard trim equations)
- Weight: 0.2 oz [5.67 g]
- Meets UL94, V-0 flammability rating
- Compliant to REACH (EC) No 1907/2006, 205 SVHC update
- Complies with UL/CSA60950-1, TUV per IEC/EN60950-1, 2<sup>nd</sup> edition
- Designed to meet Class B conducted emissions per FCC and EN55032 when used with external filter (see EMC Compliance section for recommended filter.)

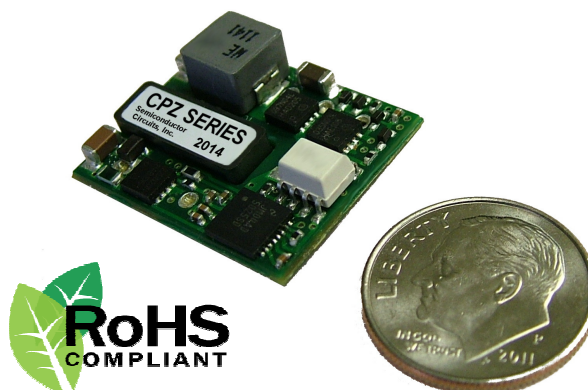

#### Description

The "Cool Power Technologies" CPZ6A24 DC-DC converter is an open frame isolated 32<sup>nd</sup> brick DC-DC module that conforms to DOSA standard 32<sup>nd</sup> brick specifications. The converter operates over an input voltage range of 18 to 36 VDC, and provides a tightly regulated output voltage with an output current rating of 6 A. The output is fully isolated from the input and the converter meets Basic Insulation requirements with 1500VDC I/O isolation rating. The standard feature set includes remote On/Off (positive or negative enable), input undervoltage lockout, output overvoltage protection, overcurrent and short circuit protections, output voltage trim, remote sense and overtemperature shutdown with hysteresis. The high efficiency of the CPZ6A24 allows operation over a wide ambient temperature range with minimal derating.



TABLE OF CONTENTS

SECTION	PAGE
FEATURES & DESCRIPTION	1
APPLICATION DIAGRAM	2
ELECTRICAL SPECIFICATIONS	3
CHARACTERISTIC PERFORMANCE CURVES	6
CHARACTERISTIC WAVEFORMS	7
APPLICATION NOTES	9
<ul style="list-style-type: none"> <li>• RIPPLE MEASUREMENTS TEST SET-UP</li> </ul>	9
<ul style="list-style-type: none"> <li>• OUTPUT VOLTAGE TRIM EQUATIONS</li> </ul>	10
<ul style="list-style-type: none"> <li>• THERMAL DERATING</li> </ul>	11
<ul style="list-style-type: none"> <li>• EMC COMPLIANCE</li> </ul>	13
MECHANICAL OUTLINE & PCB FOOTPRINT	14
ORDERING INFORMATION	16

APPLICATION DIAGRAM

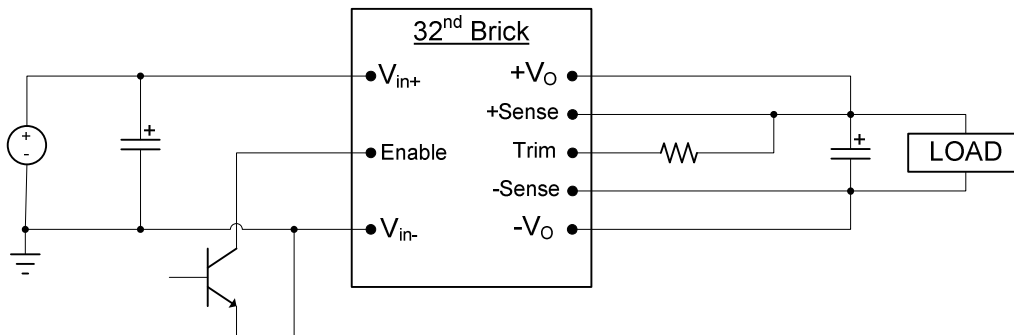

ELECTRICAL SPECIFICATIONS

18–36Vin, 5V/6Aout

Conditions:  $T_A = 25\text{ }^\circ\text{C}$ , Airflow = 300 LFM,  $V_{in} = 24\text{ VDC}$ ,  $C_{in} = 33\text{ }\mu\text{F}$ , unless otherwise specified.

Input Characteristics					
Parameter	Conditions	Min	Typ	Max	Unit
Operating Input Voltage Range		18	24	36	VDC
Input Under-Voltage Lock-out Turn-on Threshold Turn-off Threshold		17.4 15.2	17.7 15.8	18.0 16.3	VDC
Input Voltage Transient	100ms max.			50	VDC
Maximum Input Current	$V_{IN} = 18\text{VDC}; I_{out} = 6\text{A}$			2	A
Input Standby Current	Converter Disabled		2	5	mA
Input No-Load Current	Converter Enabled		60	80	mA
Short Circuit Input Current			10	20	mA <sub>RMS</sub>
Input Reflected Ripple Current	5Hz to 50MHz See Fig 17 for setup		5	10	mA <sub>PK-PK</sub>
Input Voltage Ripple Rejection	120Hz		50		dB
Inrush Current	All	-		0.05	A <sup>2</sup> -S
Output Characteristics					
Parameter	Conditions	Min	Typ	Max	Unit
Output Voltage Set point	Sense pins connected to output pins	4.925	5.00	5.075	VDC
Output Current		0		6	A
Output Current Limit Inception		6.5	7.5	10	A
Peak Short-Circuit Current	10mΩ Short		12	18	A
RMS Short-Circuit Current	10mΩ Short		1.6	2	A <sub>RMS</sub>
External Load Capacitance	Full resistive load			3300	μF
Output Ripple and Noise 20 MHz bandwidth	1 μF Ceramic + 100μF Ceramic See Fig 18 for setup		15	40	mV <sub>PK-PK</sub>
	1 μF Ceramic + 10μF Tantalum See Fig 19 for setup		50	100	mV <sub>PK-PK</sub>
Output Regulation Line: Load: Overall Output Regulation:	Over line, load & temp.	4.85	±0.04 ±0.02	±0.1 ±0.1 5.15	%Vo %Vo V



ELECTRICAL SPECIFICATIONS (continued)

18–36Vin, 5V/6Aout

Conditions:  $T_A = 25^\circ\text{C}$ , Airflow = 300 LFM, Vin = 24 VDC, Cin = 33  $\mu\text{F}$ , unless otherwise specified.

Efficiency					
Parameter	Conditions	Min	Typ	Max	Unit
Full Load	Vin = 24V	88	89		%
60% Load		88	89		%
Dynamic Response					
Parameter	Conditions	Min	Typ	Max	Unit
Load Change 25%-50% or 50%–75% of Iout Max, di/dt = 0.1 A/ $\mu\text{s}$	Cout = 1 $\mu\text{F}$ ceramic + 10 $\mu\text{F}$ tantalum See Fig 19		80	120	mV
Settling Time to 1% of Vout			50		$\mu\text{S}$
Load Change 25%-75% or 75%–25% of Iout Max, di/dt = 0.2 A/ $\mu\text{s}$	Cout = 1 $\mu\text{F}$ ceramic + 2000 $\mu\text{F}$ Oscon		20	50	mV
Settling Time to 1% of Vout			50		$\mu\text{S}$
Isolation Specifications					
Isolation Capacitance			1000		pF
Isolation Resistance		10			M $\Omega$
Isolation Voltage – Input to Output		1500			V <sub>DC</sub>
Reliability					
Per Telcordia SR-332, Issue 2: Method I, Case 3 (I <sub>o</sub> =80% of I <sub>o_max</sub> , T <sub>A</sub> =40°C, airflow = 200 lfm, 90% confidence)	MTFB		3,323,923		Hours
	FITs (failures in 10 <sup>9</sup> hours)		301		/10 <sup>9</sup> Hours



ELECTRICAL SPECIFICATIONS (continued)

18–36Vin, 5V/6Aout

Conditions: Ta = 25 °C, Airflow = 300 LFM, Vin = 24 VDC, Cin=33 µF, unless otherwise specified.

Absolute Maximum Ratings					
Parameter	Conditions	Min	Typ	Max	Unit
Input Voltage	Continuous Operation	0		36	VDC
Operating Ambient Temperature	w/derating	-40		+85	°C
Operating Temperature	T <sub>ref</sub> , see Thermal Derating section	-40		+123	°C
Storage Temperature		-55		+125	°C
Feature Characteristics					
Parameter	Conditions	Min	Typ	Max	Unit
Switching Frequency			550		kHz
Output Voltage Trim Range		-10		+10	%
Remote Sense Compensation				+10	%
Output Over-voltage Protection	Non-latching	120	130	140	%
Over-temperature Protection	Avg. PCB temp, non-latching		125		°C
Peak Backdrive Output Current (during startup into prebiased output)	Sinking current from external voltage source equal to V <sub>OUT</sub> – 0.6V and connected to the output via 1Ω resistor. C <sub>OUT</sub> =220µF, Aluminum		350	500	mA
Backdrive Output Current in OFF state	Converter disabled		0	5	mA
Power On to Output Turn-ON Time	V <sub>OUT</sub> = 0.9*V <sub>OUT_NOM</sub>		12	24	mS
Enable to Output Turn-ON Time	V <sub>OUT</sub> = 0.9*V <sub>OUT_NOM</sub>		12	24	mS
Output Enable ON/OFF					
Negative Enable					
Converter ON		-0.5		0.8	VDC
Converter OFF		2.4		20	VDC
Positive Enable					
Converter ON		2.4		20	VDC
Converter OFF		-0.5		0.8	VDC
Enable Pin Current Source/Sink			0.25	1	mA
Output Voltage Overshoot @ Startup			0	2	%Vo
Auto-Restart Period	(OVP, OCP)		100		mS

CHARACTERISTIC CURVES:

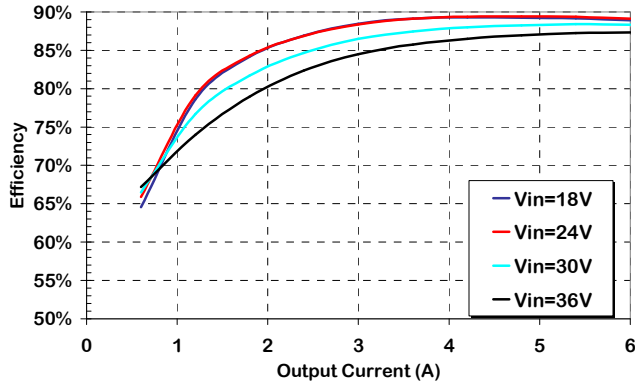

Figure 1. Efficiency vs Output Current, 300lfm airflow, 25°C ambient.

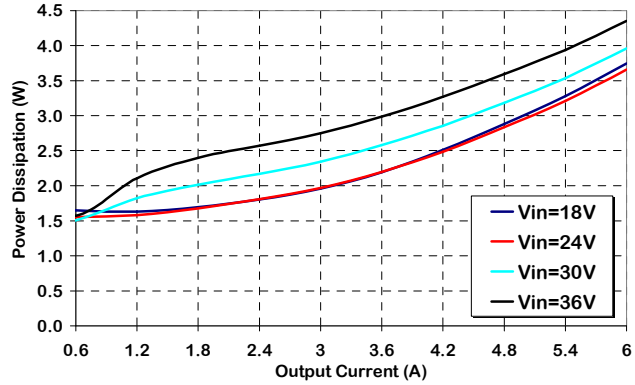

Figure 2. Power Dissipation vs. Load Current, 300lfm airflow, 25°C ambient.

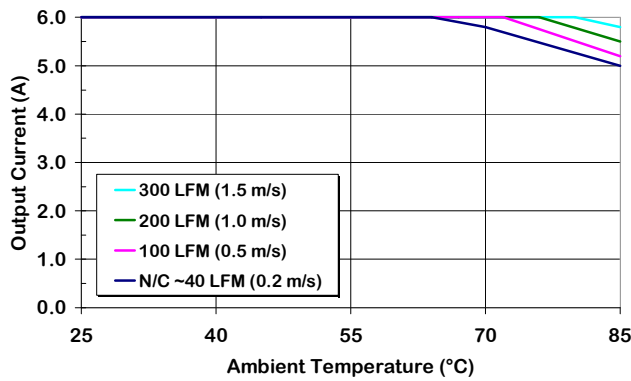

Figure 3. Output Current Derating vs Ambient Temperature & Airflow (converter mounted vertically with air flowing from pin 3 to pin 1, Vin = 24 V.)

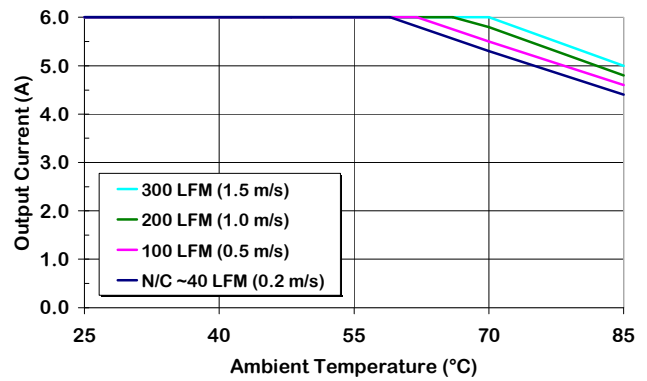

Figure 4. Output Current Derating vs Ambient Temperature & Airflow (converter mounted vertically with air flowing from pin 3 to pin 1, Vin = 18 V.)

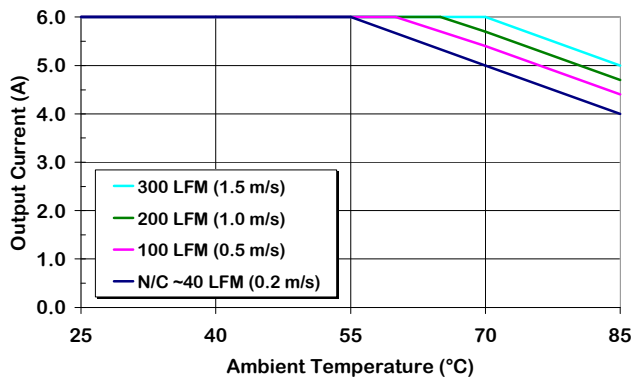

Figure 5. Output Current Derating vs Ambient Temperature & Airflow (converter mounted vertically with air flowing from 3 to 1 Vin = 36 V.)

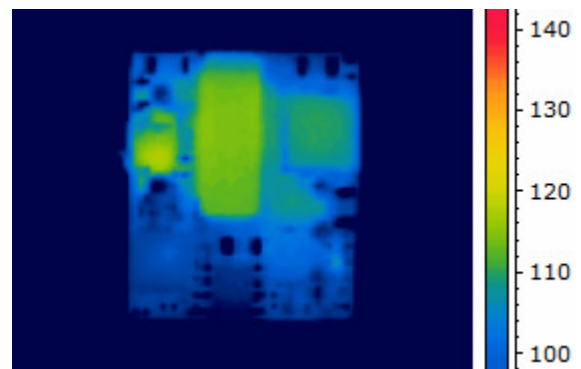

Figure 6. Thermal Image of CPZ6A24 (6A output, 70C Ambient, 200lfm airflow, Vin = 24V, T<sub>max</sub> = 118°C)

CHARACTERISTIC WAVEFORMS:

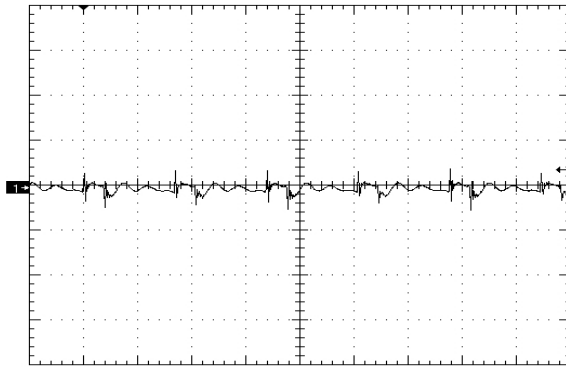

Figure 7. Output Voltage Ripple (20mV/div), time scale - 1uS/div. Vin=Vin\_nom, full load Cout=1uF ceramic + 100uF Ceramic (see Fig 2)

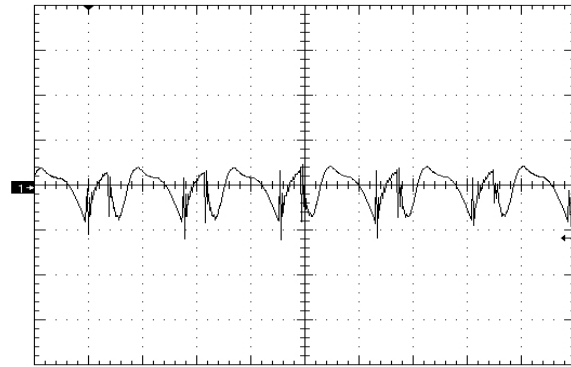

Figure 8. . Output Voltage Ripple (20mV/div), time scale - 1uS/div. Vin=Vin\_nom, full load Cout=1uF ceramic + 10uF Tantalum (see Fig 3)

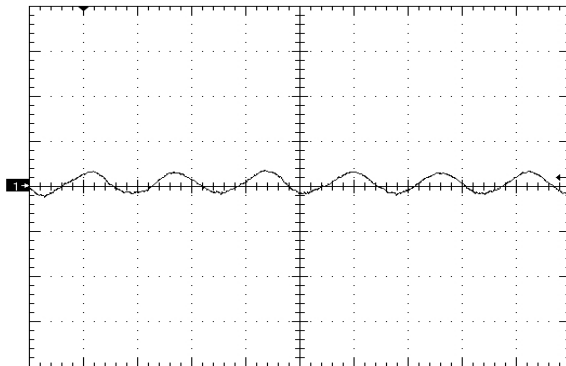

Figure 9. Input Reflected Ripple Current (5mA/div) time scale - 1uS/div. Vin=Vin\_nom, full resistive load (see Fig 1)

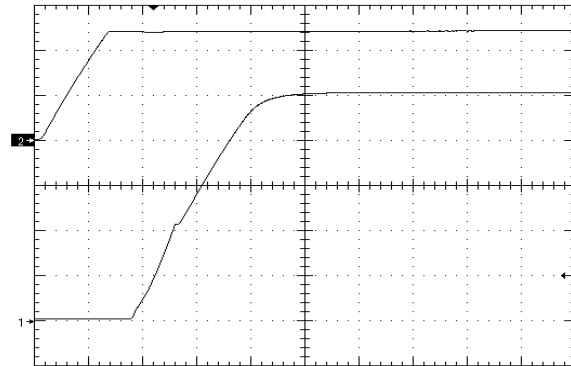

Figure 10. Startup Waveform via Input Voltage, time scale 4mS/div. Vin=Vin\_nom, lout=no load Cout=2000uF, Ch1=Vout (1V/div), Ch2=Vin (20V/div)

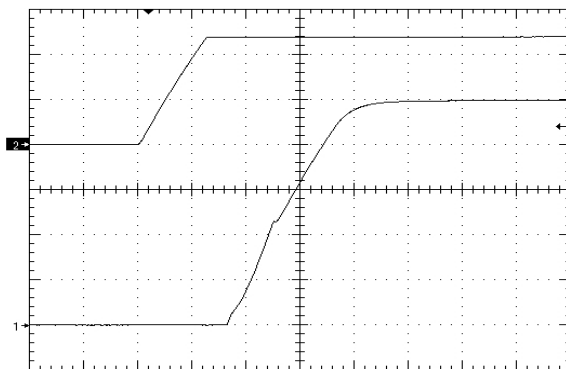

Figure 11. Startup Waveform via Input Voltage, time scale 4mS/div. Vin=Vin\_nom, full res. load + Cout=2200uF, Ch1=Vout (1V/div), Ch2=Vin (20V/div)

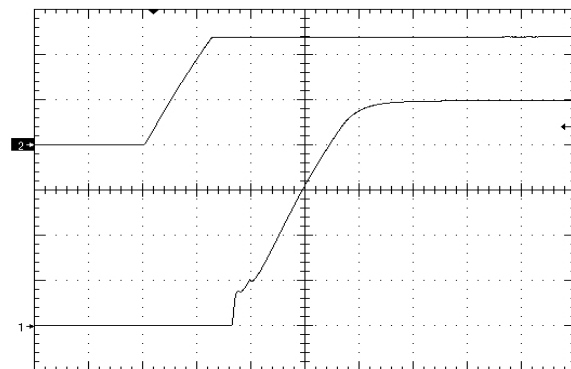

Figure 12. Startup Waveform via Input Voltage, time scale 4mS/div. Vin=Vin\_nom, full res. load + Cout=0uF, Ch1=Vout (1V/div), Ch2=Vin (20V/div)

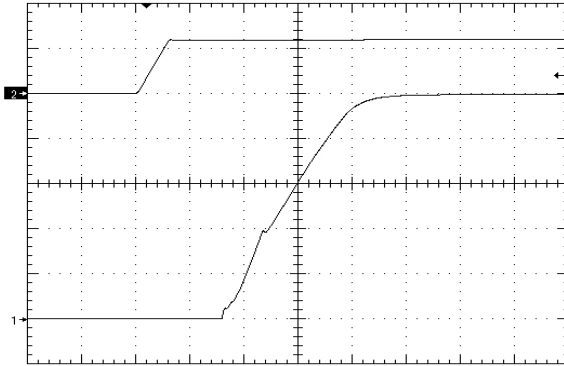

Figure 13. Startup Waveform via Input Voltage, time scale 4mS/div.  $V_{in}=24V$ , full res. load  $C_{out}=0$ , Ch1=Vout (1V/div), Ch2=Vin (20V/div)

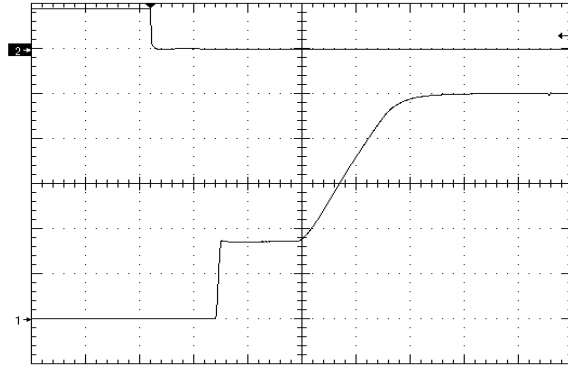

Figure 14. Startup Waveform via Enable Pin, time scale 4mS/div.  $V_{in}=V_{in\_nom}$   $I_{out}=no$  load  $C_{out}=0$ , Ch1=Vout (1V/div), Ch2=enable (5V/div)

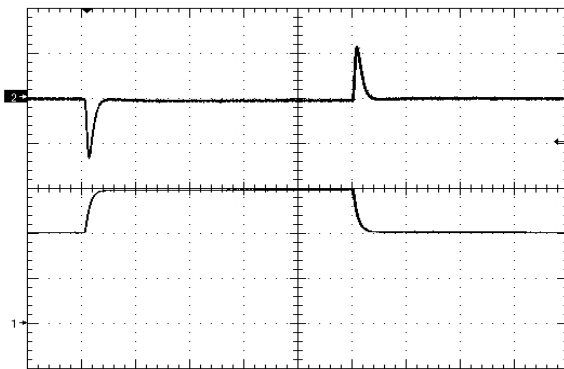

Figure 15. Load Transient Response (50mV/div),  $di/dt=0.1A/\mu S$ , 50% - 75% - 50% of full load,  $C_{out}=Fig3$  time scale: 200µS/div. Ch1=Vout, Ch2=Iout (1A/div)

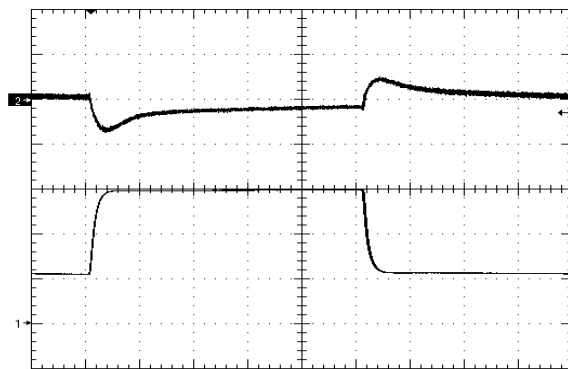

Figure 16. Load Load Transient Response 20mV/div),  $di/dt=0.2A/\mu S$ , 25% - 75% - 25% of full load +2000µF low ESR Oscon, time scale: 200µS/div. Ch1=Vout, Ch2=Iout (1A/div)





## Application Notes

### INPUT REFLECTED RIPPLE TEST SETUP:

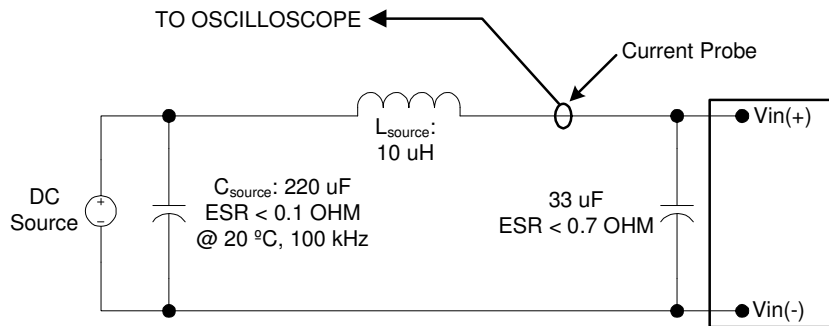

Note: Measure input reflected-ripple current with a simulated source inductance ( $L_{test}$ ) of 10  $\mu\text{H}$ . Capacitor  $C_s$  offsets possible source impedance.

Figure 17. Input Reflected-ripple Current Test Setup.

### OUTPUT RIPPLE TEST SETUP:

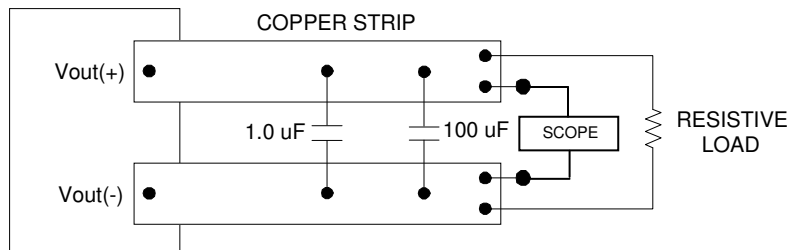

Use a 1.0 $\mu\text{F}$  X7R ceramic capacitor and 100 $\mu\text{F}$  X5R ceramic capacitor. Scope measurement made using a BNC socket. Position the load 3 in. [76mm] from module.

Figure 18. Peak-to-Peak Output Noise Measurement Test Setup.

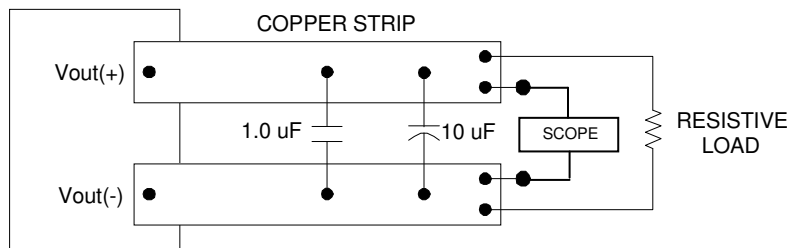

Use a 1.0 $\mu\text{F}$  X7R ceramic capacitor and 10 $\mu\text{F}$  @20V low ESR tantalum capacitor. Scope measurement made using a BNC socket. Position the load 3 in. [76mm] from module.

Figure 19. Peak-to-Peak Output Noise Measurement Test Setup (alternate.)

### Application Notes (cont)

#### OUTPUT VOLTAGE TRIM:

Output voltage adjustment is accomplished by connecting an external resistor between the Trim Pin and either the +Vout (or +Sense) or -Vout (or -Sense) Pins.

#### TRIM UP EQUATION:

$$R_{trim\_up} = \left[ \frac{5.1 \times V_{o\_nom} \times (100 + \Delta\%)}{1.225 \times \Delta\%} - \frac{510}{\Delta\%} - 10.2 \right] \times k\Omega$$

Where  $R_{trim\_up}$  is the resistance value in k-ohms and  $\Delta\%$  is the percent change in the output voltage.

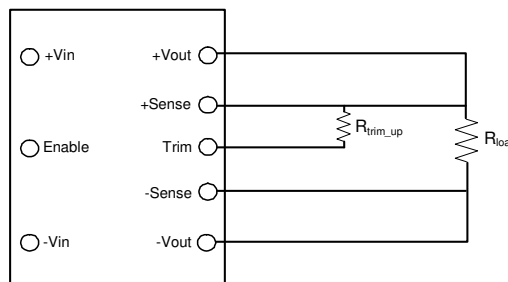

Figure 20. Trim UP circuit configuration

#### TRIM-DOWN EQUATION:

$$R_{trim\_down} = \left( \frac{510}{\Delta\%} - 10.2 \right) \times k\Omega$$

Where  $R_{trim\_down}$  is the resistance value in k ohms and  $\Delta\%$  is the percent change in the output voltage.

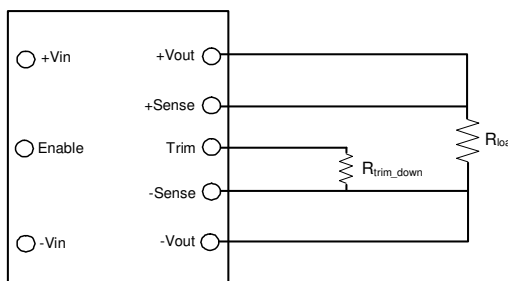
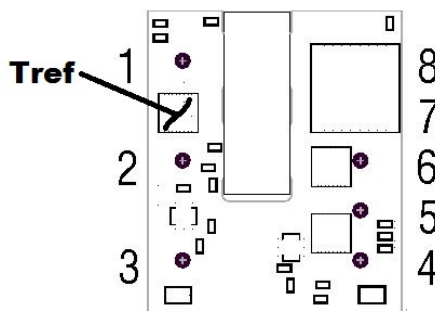

Figure 21. Trim DOWN circuit configuration

## Application Notes (cont)

### Thermal Derating

- It is preferable that the DC-DC module have an unobstructed flow of air across it for best thermal performance. Components taller than ~ 2mm in front of the module can deflect airflow and possibly create hotspots.
- Significant cooling is achieved through conductive flow from the modules I/O pins to the host PCB. Sufficiently large traces connecting the dc-dc converter to the source and load will help ensure thermal derating performance will meet or exceed the derating curves published in this datasheet.
- If the module is expected to be operated near the load limits defined in the derating curves, in-system verification of module derating performance should be performed to ensure long-term system reliability. Peak temperatures are to be measured using infrared thermography or by gluing a fine gauge (AWG #40) thermocouple at the  $T_{ref}$  location(s) shown below. Temperature at the specified location(s) is not to exceed 123°C in order to meet derating guidelines.



### Input Undervoltage Lockout

- The converter is disabled until the input voltage has exceeded the UVLO turn-on threshold. Once the input voltage exceeds this level (see Input Under-Voltage Lock-out in Electrical Specifications table) the module will commence soft-start. Hysteresis of 1-2 volts minimizes the likelihood of pulling the input voltage below the turn-off threshold during startup which could create an undesirable on/off cycling condition. The converter will continue to operate until the input voltage subsequently falls below the UVLO turn-off threshold.

### Enable Pin Function

- The module has a remote enable function that allows it to be turned on or off remotely. The Enable pin is referenced to the negative input pin (-Vin) of the converter. Modules can be ordered with either negative or positive enable.
- The negative enable option the module will not turn on unless the enable pin is connected to -Vin. The positive enable option allows the converter to turn on as soon as voltage sufficient to exceed the UVLO of the converter has been applied to the input terminals. In this case the module is turned off by connecting the Enable pin to -Vin. On/off thresholds are located in the Electrical Specifications table.

## Application Notes (cont)

### Output Overvoltage Protection

- The module has an independent feedback loop that will disable the output of the converter if a voltage greater than about 125% of the nominal set point is detected. When this threshold is reached, the converter will shut down and remain off for the amount of time specified by the Auto-Restart Period. The converter will attempt a restart once this period of time has elapsed.

### Output Overtemperature Protection

- To provide protection under certain fault conditions, the unit is equipped with a thermal shutdown circuit. The unit will shutdown if the average PCB temperature exceeds approx. 135°C, but the thermal shutdown is not intended as a guarantee that the unit will survive temperatures beyond its rating. The module will automatically restart once it has cooled below the shutdown temperature minus hysteresis (typically 20 deg C.)

### SMT Version Layout Considerations (if applicable)

- Copper traces with sufficient cross-section must be provided for all output & input pins. SMT pads tied to internal power/ground planes must have multiple vias around each SMT pad to couple expected current loads from module pins into internal traces/planes. One 0.024" (0.6mm) diameter via for each 4A of expected source or load current must be provided as close to the termination as possible, preferably in the direction of current flow from SMT pad to load. Vias must be at least 0.024" (0.6 mm) away from the SMT pad to prevent solder from flowing into the vias.
- SMT pads on the host card are to be 0.080" (2.03 mm) diameter. Solder paste screen opening should be 0.075" (1.9 mm) diameter and the screen should be 0.006" (0.15 mm) thick (other thicknesses are possible; 0.006" provides a good compromise between solder volume and coplanarity compensation.)

### Paralleling Converters

- Modules may be paralleled but it is recommended that the total power draw not exceed the output power rating of a single module. External sharing controllers are recommended for reliability and to ensure equal distribution of the load to the converters. In lower current applications, ORing diodes can be used to prevent converter interactions and improve current sharing.



**EMC COMPLIANCE:**

To meet Class B compliance for EN55032 (CISPR 32) or FCC part 15 sub part j, the following input filter is required:

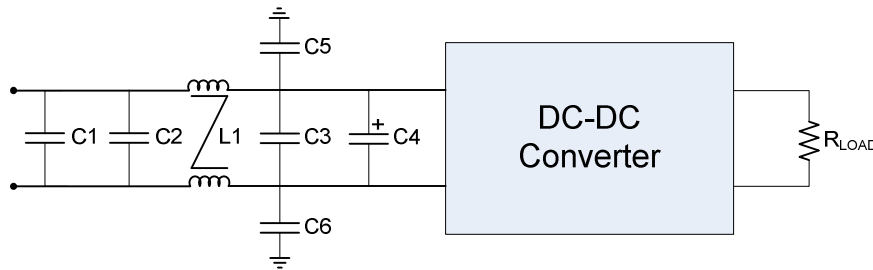

Figure 22. EMI Filter

L1 =	1.32 mH Common Mode Inductor (Pulse P0422NL)
C1,C2,C3 =	2.2uF ceramic
C4 =	100uF electrolytic
C5,C6 =	10nF (@2kV if output is ref. to gnd.)

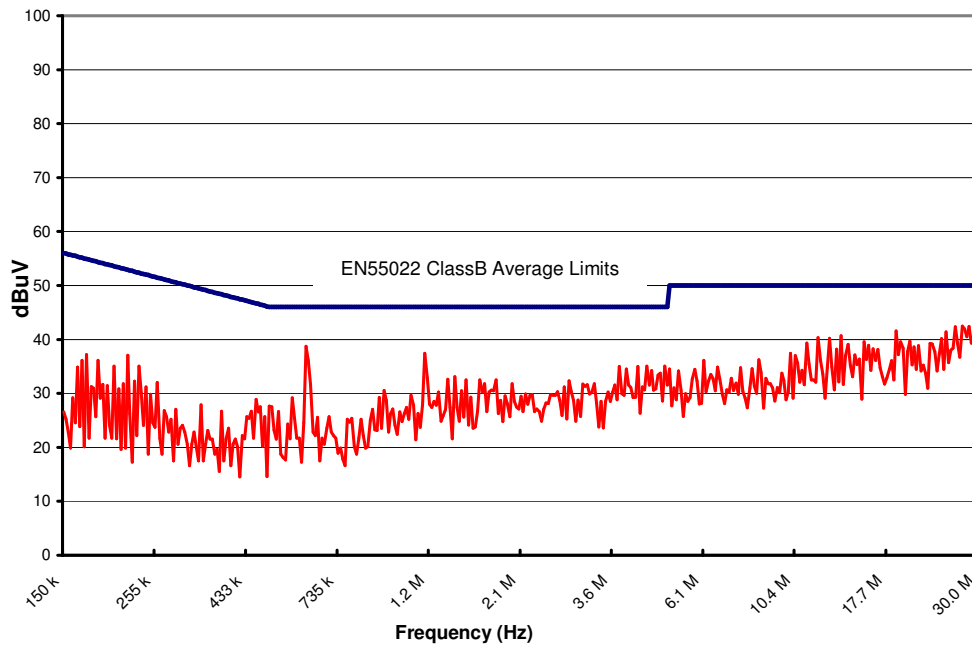
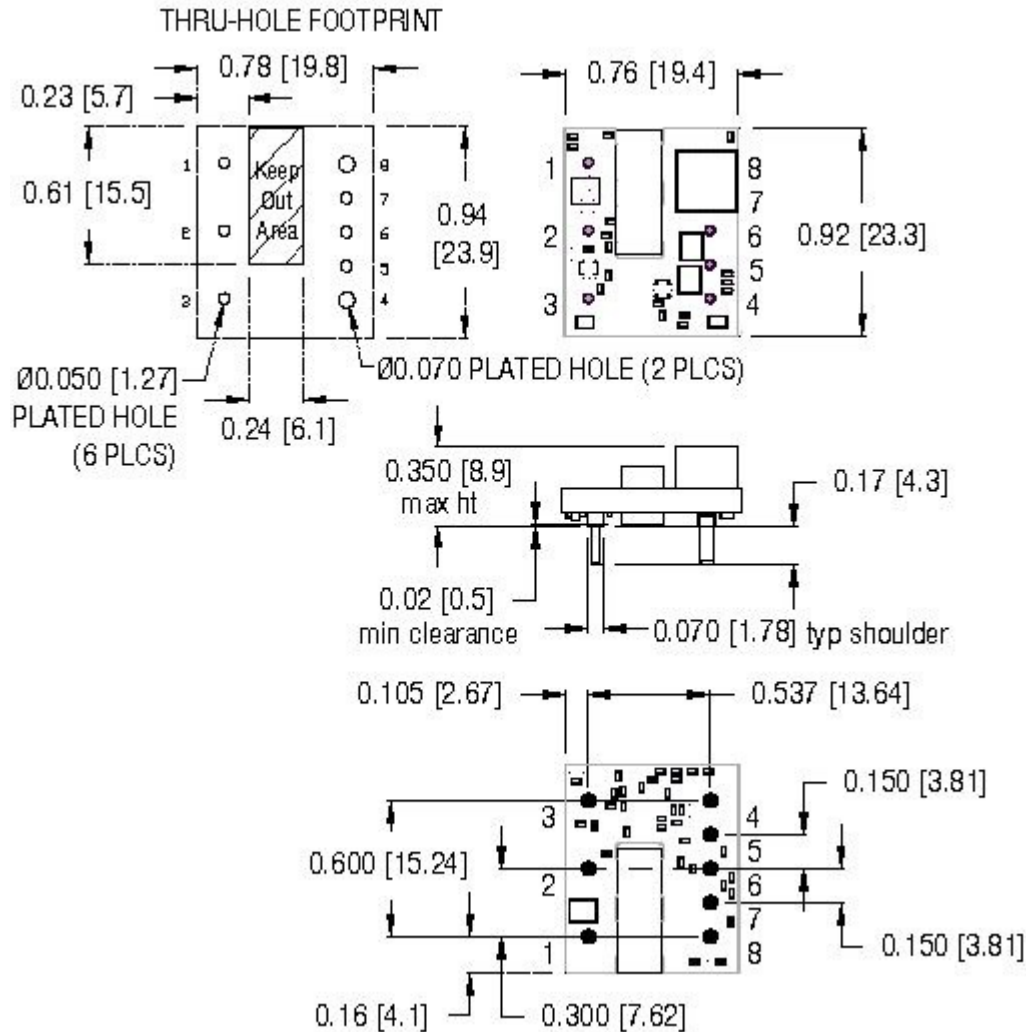

Figure 23. CPZ6A24 Conducted Emissions using above specified input filter.  
 Vin = 48V, Full Resistive Load

MODULE PIN ASSIGNMENT:

PIN #	DESIGNATION	NOTES
1	V <sub>IN</sub> (+)	1) All dimensions in inches [mm] Tolerances: .xx ± 0.02 [.x ± .5] .xxx ± 0.010 [.xx ± .25]
2	On/Off	
3	V <sub>IN</sub> (-)	2) TH pins 1-3 & 5-7 are Ø 0.040" [1.02] with Ø 0.070" [1.77] standoff shoulders.
4	V <sub>OUT</sub> (-)	3) TH output pins 4 & 8 are Ø 0.062" [1.57] with 0.090" [2.29] standoff shoulder.
5	Sense (-)	4) SMT pins are 0.060" diameter round cylinders
6	Trim	5) Keep Out Area – no copper traces or vias should be placed in this area.
7	Sense (+)	6) All pins are gold plated with nickel under plating (ROHS).
8	V <sub>OUT</sub> (+)	7) Weight: 5.67 g (0.2 oz.)
		8) Workmanship: Meets or exceeds IPC-A-610 Class II

MECHANICAL OUTLINE – THROUGH-HOLE:





<b>Ordering Information:</b>					
<b>Product Identifier</b>	<b>Output Current</b>	<b>Output Voltage</b>	<b>Input Voltage</b>	<b>Enable logic option</b>	<b>Additional features</b>
CPZ	6	A	24	N or P	S
"Cool Power" 32 <sup>nd</sup> Brick	6A	5V	18 – 36V	N = Negative P = Positive	S = Surface Mount

Rev 1.02, 29-October-20

