

MOSFET – N-Channel, POWERTRENCH

150 V, 167 A, 5.9 mΩ

FDH055N15A

Description

This N-Channel MOSFET is produced using ON Semiconductor's advanced POWERTRENCH® process that has been tailored to minimize the on-state resistance while maintaining superior switching performance.

Features

- $R_{DS(on)} = 4.8 \text{ m}\Omega$ (Typ.) @ $V_{GS} = 10 \text{ V}$, $I_D = 120 \text{ A}$
- Fast Switching Speed
- Low Gate Charge
- High Performance Trench Technology for Extremely Low $R_{DS(on)}$
- High Power and Current Handling Capability
- This Device is Pb-Free and is RoHS Compliant

Applications

- Synchronous Rectification for ATX / Server / Telecom PSU
- Battery Protection Circuit
- Motor Drives and Uninterruptible Power Supplies
- Micro Solar Inverter



ON Semiconductor®

www.onsemi.com

V_{DS}	$R_{DS(on)} \text{ MAX}$	$I_D \text{ MAX}$
150 V	5.9 mΩ @ 10 V	167 A

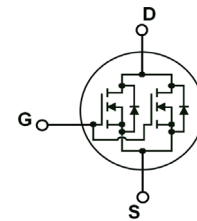

N-CHANNEL MOSFET

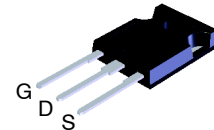

TO-247-3LD
CASE 340CK

MARKING DIAGRAM

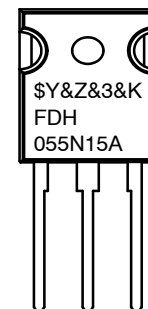

\$Y	= ON Semiconductor Logo
&Z	= Assembly Plant Code
&3	= Numeric Date Code
&K	= Lot Code
FDH055N15A	= Specific Device Code

ORDERING INFORMATION

See detailed ordering and shipping information on page 2 of this data sheet.

FDH055N15A

ABSOLUTE MAXIMUM RATINGS (T_C = 25°C unless otherwise noted)

Symbol	Parameter		FDH055N15A	Unit
V _{DSS}	Drain to Source Voltage		150	V
V _{GSS}	Gate to Source Voltage	- DC	±20	V
		- AC (f > 1 Hz)	±30	
I _D	Drain Current	- Continuous (T _C = 25°C, Silicon Limited)	167 (Note 1)	A
		- Continuous (T _C = 100°C, Silicon Limited)	118	
		- Continuous (T _C = 25°C, Package Limited)	156	
I _{DM}	Drain Current	- Pulsed (Note 2)	668	A
E _{AS}	Single Pulsed Avalanche Energy (Note 3)		835	mJ
dv/dt	Peak Diode Recovery dv/dt (Note 4)		6.0	V/ns
P _D	Power Dissipation	(T _C = 25°C)	429	W
		- Derate above 25°C	2.86	W/°C
T _J , T _{STG}	Operating and Storage Temperature Range		-55 to + 175	°C
T _L	Maximum Lead Temperature for Soldering, 1/8" from Case for 5 Second		300	°C

Stresses exceeding those listed in the Maximum Ratings table may damage the device. If any of these limits are exceeded, device functionality should not be assumed, damage may occur and reliability may be affected.

1. Calculated continuous current based on maximum allowable junction temperature, Package limitation current is 156 A.
2. Repetitive Rating: Pulse width limited by maximum junction temperature.
3. Starting T_J = 25°C, L = 3 mH, I_{AS} = 23.6 A
4. I_{SD} ≤ 120 A, di/dt ≤ 200 A/s, V_{DD} ≤ BV_{DSS}, Starting T_J = 25 °C.

THERMAL CHARACTERISTICS

Symbol	Parameter	FDH055N15A	Unit
R _{θJC}	Thermal Resistance, Junction to Case, Max.	0.35	°C/W
R _{θJA}	Thermal Resistance, Junction to Ambient, Max.	40	

PACKAGE MARKING AND ORDERING INFORMATION

Part Number	Top Mark	Package	Package Method	Reel Size	Tape Width	Quantity
FDH055N15A	FDH055N15A	TO-247-3LD	Tube	N/A	N/A	30 Units

FDH055N15A

ELECTRICAL CHARACTERISTICS (T_C = 25°C unless otherwise noted)

Symbol	Parameter	Test Condition	Min.	Typ.	Max.	Unit
--------	-----------	----------------	------	------	------	------

OFF CHARACTERISTICS

BV _{DSS}	Drain to Source Breakdown Voltage	I _D = 250 μA, V _{GS} = 0 V	150	–	–	V
ΔBV _{DSS} / ΔT _J	Breakdown Voltage Temperature Coefficient	I _D = 250 μA, Referenced to 25°C	–	0.1	–	V/°C
I _{DSS}	Zero Gate Voltage Drain Current	V _{DS} = 120 V, V _{GS} = 0 V	–	–	1	μA
		V _{DS} = 120 V, T _C = 150°C	–	–	500	
I _{GSS}	Gate to Body Leakage Current	V _{GS} = ±20 V, V _{DS} = 0 V	–	–	±100	nA

ON CHARACTERISTICS

V _{GS(th)}	Gate Threshold Voltage	V _{GS} = V _{DS} , I _D = 250 μA	2.0	–	4.0	V
R _{DS(on)}	Static Drain to Source On Resistance	V _{GS} = 10 V, I _D = 120 A	–	4.8	5.9	mΩ
g _{FS}	Forward Transconductance	V _{DS} = 10 V, I _D = 120 A	–	219	–	S

DYNAMIC CHARACTERISTICS

C _{iss}	Input Capacitance	V _{DS} = 75 V, V _{GS} = 0 V, f = 1 MHz	–	7100	9445	pF
C _{oss}	Output Capacitance		–	664	885	pF
C _{rss}	Reverse Transfer Capacitance		–	23	35	pF
C _{oss(er)}	Energy Related Output Capacitance	V _{DS} = 75 V, V _{GS} = 0 V	–	1159	–	pF
Q _{g(tot)}	Total Gate Charge at 10 V	V _{DS} = 75 V, I _D = 120 A, V _{GS} = 10 V (Note 5)	–	92	–	nC
Q _{gs}	Gate to Source Gate Charge		–	31	–	nC
Q _{gs2}	Gate Charge Threshold to Plateau		–	15	–	nC
Q _{gd}	Gate to Drain “Miller” Charge		–	16	–	nC
ESR	Equivalent Series Resistance(G–S)	f = 1 MHz	–	1.2	–	Ω

SWITCHING CHARACTERISTICS

t _{d(on)}	Turn-On Delay Time	V _{DD} = 75 V, I _D = 120 A, V _{GS} = 10 V, R _G = 4.7 Ω (Note 5)	–	35	80	ns
t _r	Turn-On Rise Time		–	67	144	ns
t _{d(off)}	Turn-Off Delay Time		–	71	152	ns
t _f	Turn-Off Fall Time		–	21	52	ns

DRAIN-SOURCE DIODE CHARACTERISTICS

I _S	Maximum Continuous Drain to Source Diode Forward Current		–	–	167 (Note 1)	A
I _{SM}	Maximum Pulsed Drain to Source Diode Forward Current		–	–	668	A
V _{SD}	Drain to Source Diode Forward Voltage	V _{GS} = 0 V, I _{SD} = 120 A	–	–	1.25	V
t _{rr}	Reverse Recovery Time	V _{GS} = 0 V, I _{SD} = 120 A, V _{DS} = 75 V, dI _F /dt = 100 A/μs	–	105	–	ns
Q _{rr}	Reverse Recovery Charge		–	342	–	nC
Q _{rr}	Reverse Recovery Charge	V _{GS} = 0 V, I _{SD} = 30 A, V _{DS} = 75 V, dI _F /dt = 100 A/μs	–	348	–	nC

Product parametric performance is indicated in the Electrical Characteristics for the listed test conditions, unless otherwise noted. Product performance may not be indicated by the Electrical Characteristics if operated under different conditions.

5. Essentially Independent of Operating Temperature Typical Characteristics.

TYPICAL CHARACTERISTICS

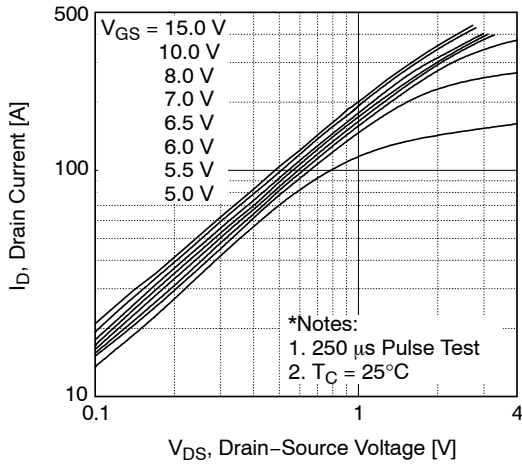

Figure 1. On-Region Characteristics

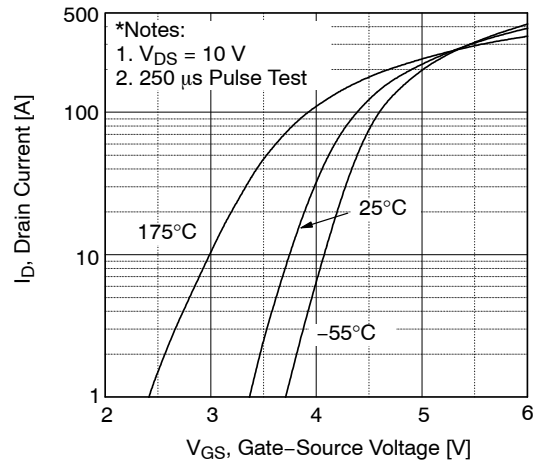

Figure 2. Transfer Characteristics

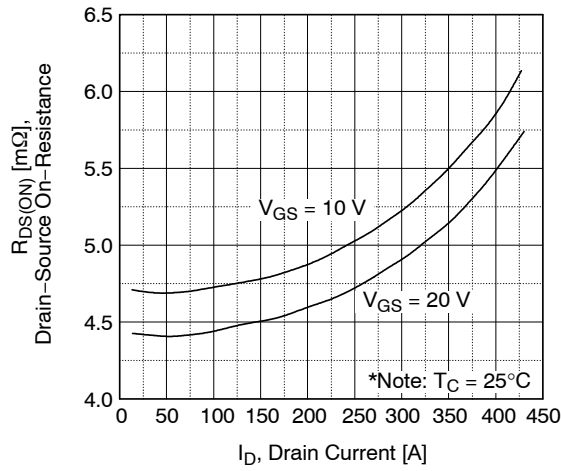

Figure 3. On-Resistance Variation vs. Drain Current and Gate Voltage

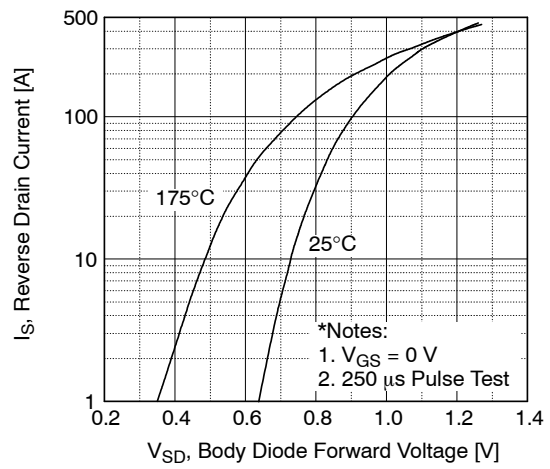

Figure 4. Body Diode Forward Voltage Variation vs. Source Current and Temperature

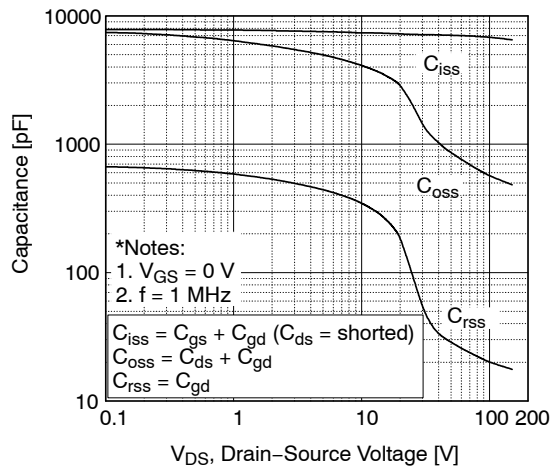

Figure 5. Capacitance Characteristics

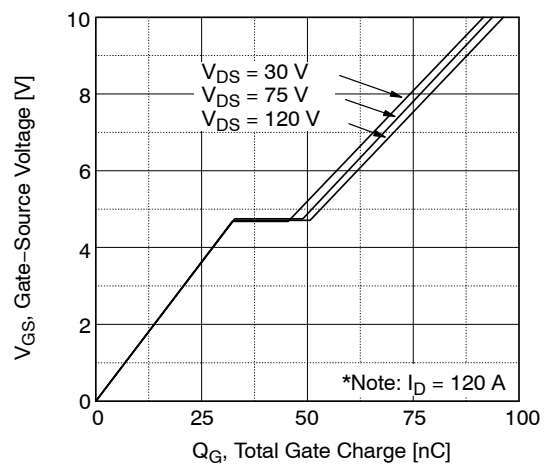

Figure 6. Gate Charge Characteristics

TYPICAL CHARACTERISTICS (continued)

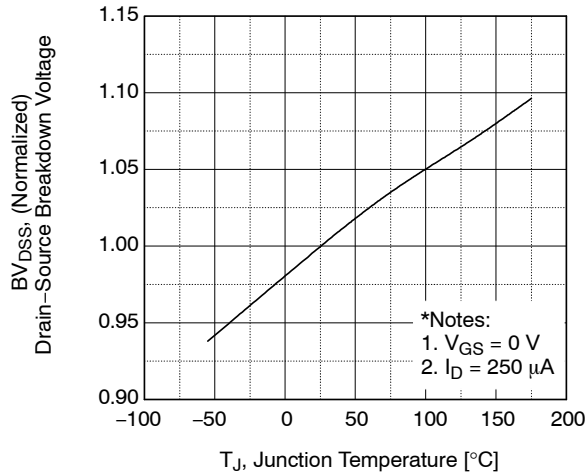

Figure 7. Breakdown Voltage Variation vs. Temperature

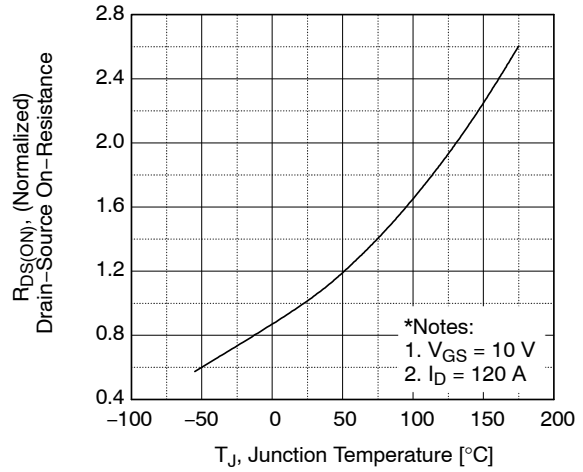

Figure 8. On-Resistance Variation vs. Temperature

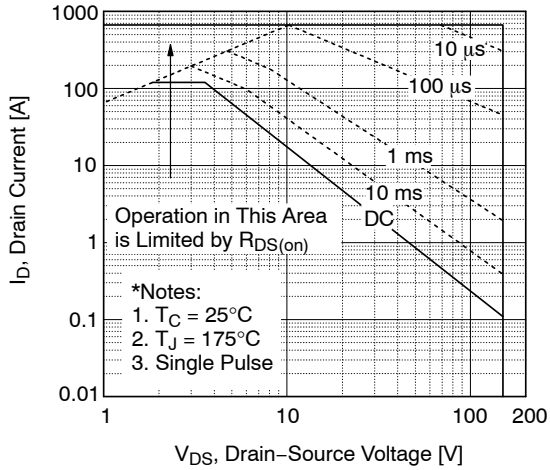

Figure 9. Maximum Safe Operating Area

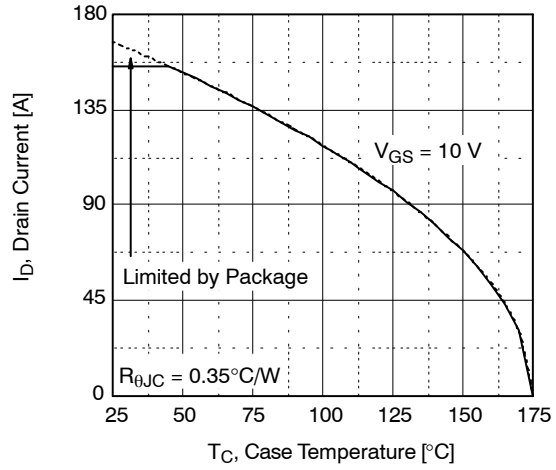

Figure 10. Maximum Drain Current vs. Case Temperature

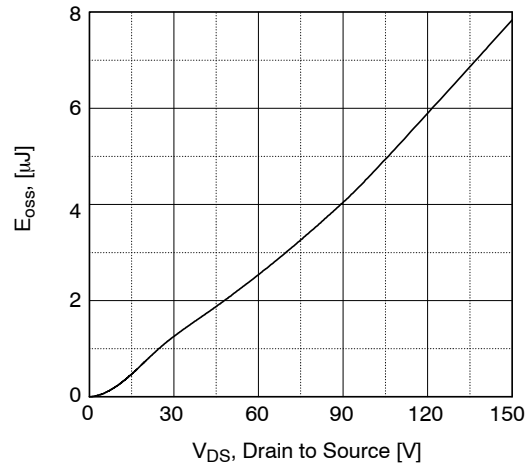

Figure 11. E_{oss} vs. Drain to Source Voltage

FDH055N15A

TYPICAL CHARACTERISTICS (continued)

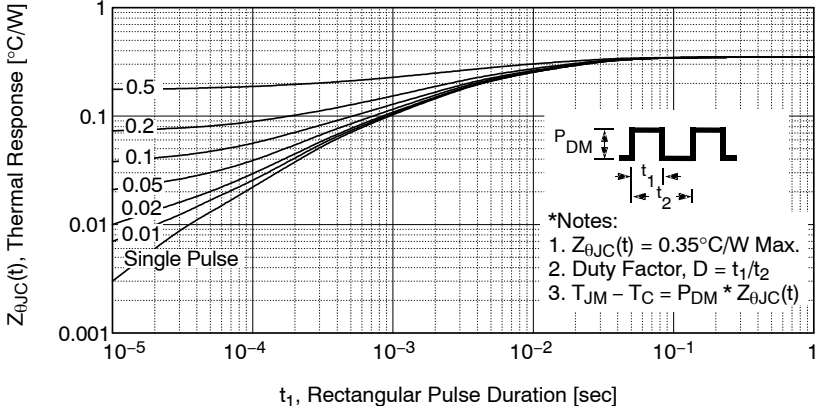

Figure 12. Transient Thermal Response Curve

FDH055N15A

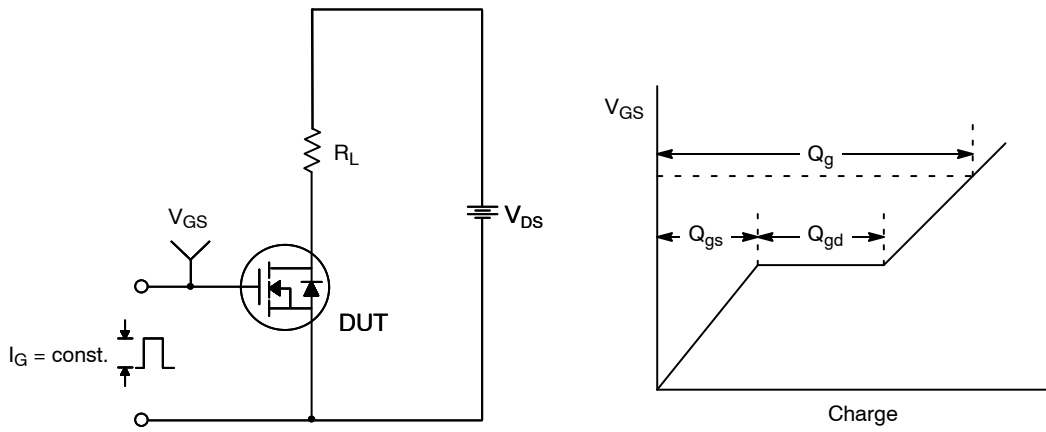

Figure 13. Gate Charge Test Circuit & Waveform

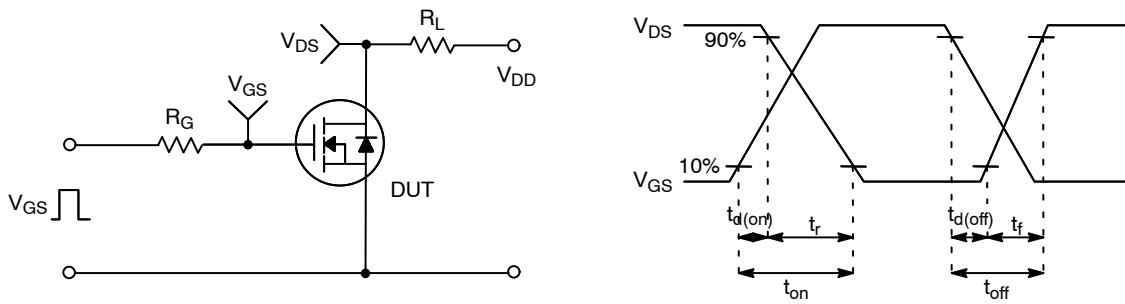

Figure 14. Resistive Switching Test Circuit & Waveforms

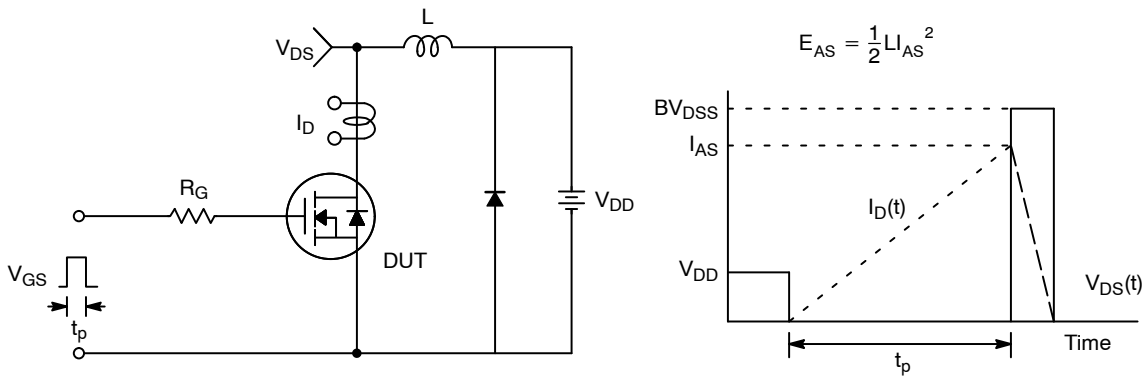

Figure 15. Unclamped Inductive Switching Test Circuit & Waveforms

FDH055N15A

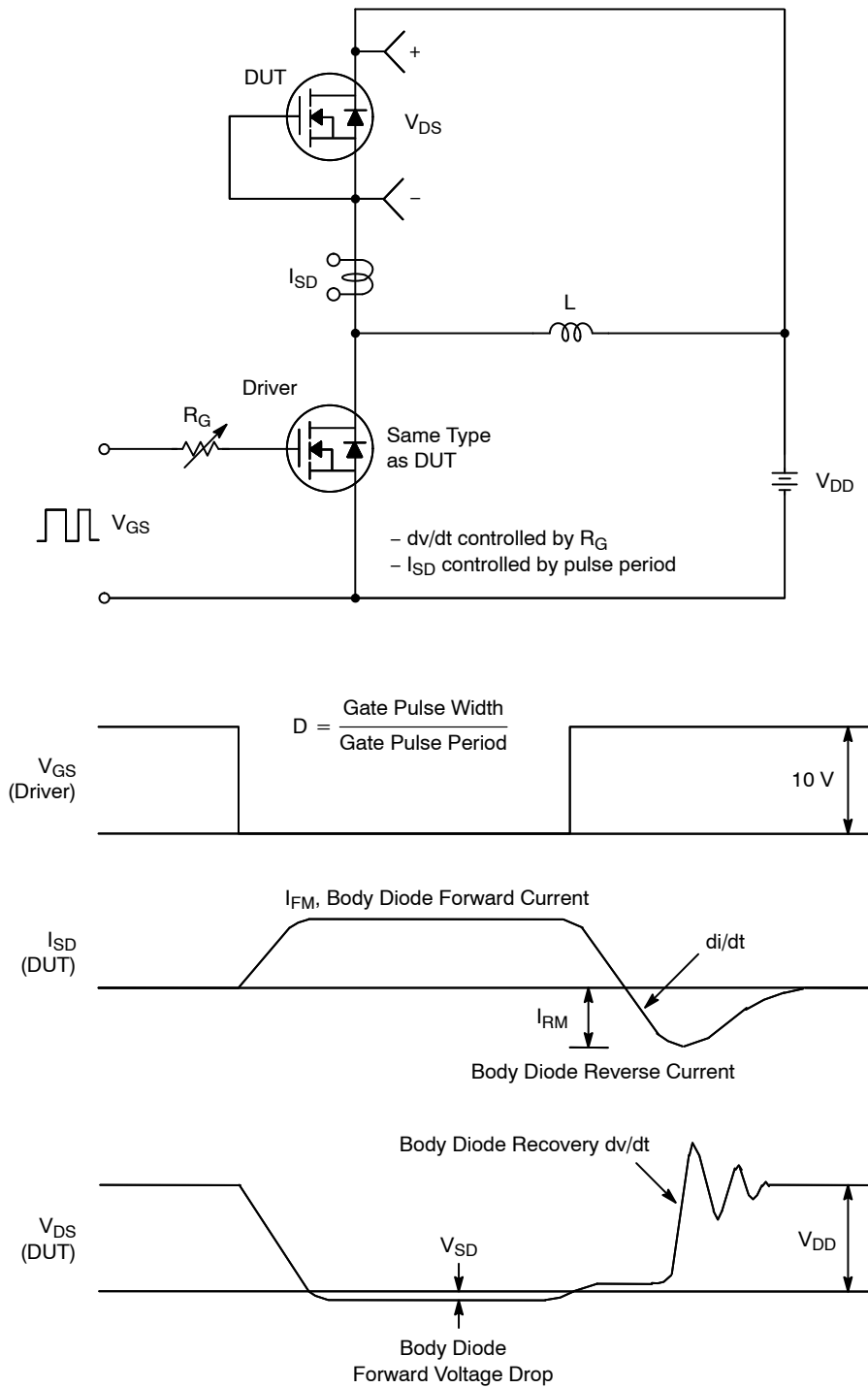

Figure 16. Peak Diode Recovery dv/dt Test Circuit & Waveforms

TO-247-3LD SHORT LEAD
CASE 340CK
ISSUE A

DATE 31 JAN 2019



NOTES: UNLESS OTHERWISE SPECIFIED.

- A. DIMENSIONS ARE EXCLUSIVE OF BURRS, MOLD FLASH, AND TIE BAR EXTRUSIONS.
- B. ALL DIMENSIONS ARE IN MILLIMETERS.
- C. DRAWING CONFORMS TO ASME Y14.5 - 2009.
- D. DIMENSION A1 TO BE MEASURED IN THE REGION DEFINED BY L1.
- E. LEAD FINISH IS UNCONTROLLED IN THE REGION DEFINED BY L1.

GENERIC MARKING DIAGRAM*



XXXX = Specific Device Code
 A = Assembly Location
 Y = Year
 WW = Work Week
 ZZ = Assembly Lot Code

*This information is generic. Please refer to device data sheet for actual part marking. Pb-Free indicator, "G" or microdot "•", may or may not be present. Some products may not follow the Generic Marking.

DIM	MILLIMETERS		
	MIN	NOM	MAX
A	4.58	4.70	4.82
A1	2.20	2.40	2.60
A2	1.40	1.50	1.60
b	1.17	1.26	1.35
b2	1.53	1.65	1.77
b4	2.42	2.54	2.66
c	0.51	0.61	0.71
D	20.32	20.57	20.82
D1	13.08	~	~
D2	0.51	0.93	1.35
E	15.37	15.62	15.87
E1	12.81	~	~
E2	4.96	5.08	5.20
e	~	5.56	~
L	15.75	16.00	16.25
L1	3.69	3.81	3.93
ØP	3.51	3.58	3.65
ØP1	6.60	6.80	7.00
Q	5.34	5.46	5.58
S	5.34	5.46	5.58

DOCUMENT NUMBER:	98AON13851G	Electronic versions are uncontrolled except when accessed directly from the Document Repository. Printed versions are uncontrolled except when stamped "CONTROLLED COPY" in red.
DESCRIPTION:	TO-247-3LD SHORT LEAD	PAGE 1 OF 1

ON Semiconductor and are trademarks of Semiconductor Components Industries, LLC dba ON Semiconductor or its subsidiaries in the United States and/or other countries. ON Semiconductor reserves the right to make changes without further notice to any products herein. ON Semiconductor makes no warranty, representation or guarantee regarding the suitability of its products for any particular purpose, nor does ON Semiconductor assume any liability arising out of the application or use of any product or circuit, and specifically disclaims any and all liability, including without limitation special, consequential or incidental damages. ON Semiconductor does not convey any license under its patent rights nor the rights of others.

onsemi, **Onsemi**, and other names, marks, and brands are registered and/or common law trademarks of Semiconductor Components Industries, LLC dba "**onsemi**" or its affiliates and/or subsidiaries in the United States and/or other countries. **onsemi** owns the rights to a number of patents, trademarks, copyrights, trade secrets, and other intellectual property. A listing of **onsemi**'s product/patent coverage may be accessed at www.onsemi.com/site/pdf/Patent-Marking.pdf. **onsemi** reserves the right to make changes at any time to any products or information herein, without notice. The information herein is provided "as-is" and **onsemi** makes no warranty, representation or guarantee regarding the accuracy of the information, product features, availability, functionality, or suitability of its products for any particular purpose, nor does **onsemi** assume any liability arising out of the application or use of any product or circuit, and specifically disclaims any and all liability, including without limitation special, consequential or incidental damages. Buyer is responsible for its products and applications using **onsemi** products, including compliance with all laws, regulations and safety requirements or standards, regardless of any support or applications information provided by **onsemi**. "Typical" parameters which may be provided in **onsemi** data sheets and/or specifications can and do vary in different applications and actual performance may vary over time. All operating parameters, including "Typicals" must be validated for each customer application by customer's technical experts. **onsemi** does not convey any license under any of its intellectual property rights nor the rights of others. **onsemi** products are not designed, intended, or authorized for use as a critical component in life support systems or any FDA Class 3 medical devices or medical devices with a same or similar classification in a foreign jurisdiction or any devices intended for implantation in the human body. Should Buyer purchase or use **onsemi** products for any such unintended or unauthorized application, Buyer shall indemnify and hold **onsemi** and its officers, employees, subsidiaries, affiliates, and distributors harmless against all claims, costs, damages, and expenses, and reasonable attorney fees arising out of, directly or indirectly, any claim of personal injury or death associated with such unintended or unauthorized use, even if such claim alleges that **onsemi** was negligent regarding the design or manufacture of the part. **onsemi** is an Equal Opportunity/Affirmative Action Employer. This literature is subject to all applicable copyright laws and is not for resale in any manner.

ADDITIONAL INFORMATION

TECHNICAL PUBLICATIONS:

Technical Library: www.onsemi.com/design/resources/technical-documentation
onsemi Website: www.onsemi.com

ONLINE SUPPORT: www.onsemi.com/support

For additional information, please contact your local Sales Representative at www.onsemi.com/support/sales