

SUMMARY



Image is for illustrative purpose only

Wires

Low voltage 7

Series	2B
Termination type	Female solder
IP rating	68 when mated
AWG wire size	28.00 - 20.00
Cable Ø	0.00 - 0.00 mm
Status	active
Matching parts	FGG.2B.307.CLAD52

Download

[Request a quote](#)

[Catalog](#)

TECHNICAL DETAILS

Mechanics

Shell Style/Model	HC*: Fixed receptacle, nut fixing, watertight or vacuum-tight (watertight when mated, back panel mounting)
Keying	1 key (alpha=0, plug: male contacts, receptacle: female contacts)
Housing Material	Brass (chrome plated [SAE AMS 2460]) shell and collet nut, nickel plated [SAE AMS QQ N 290] brass latch sleeve and mid pieces
Variant	P : Watertight unmated
Weight	37.08 g

Performance

Configuration	2B.307 : 7 Low Voltage
Insulator	L: PEEK (UL 94 / V-0/1.5)
Rated Current	11 Amps

Specifications

Contact Type:	Solder
Contact Dia.:	1.3 mm (0.051in)
Bucket Dia.:	1 mm (0.039in)
Max. Solid Conductor:	0.5 mm ² (AWG 20)
Max. Stranded Conductor:	0.5 mm ² (AWG 20)

LEMO products and services are provided "as is". LEMO makes no warranties or representations with regard to LEMO product & services or use of them, express, implied or statutory, including for accuracy, completeness, or security. The user is fully responsible for his products and applications using LEMO components.

R (max): 3.6 mOhm
 Vtest (contact-shell): 1600 V (AC), 2250 V (DC)
 Vtest (contact-contact): 1750 V (AC), 2500 V (DC)

Others

Endurance (Shell): 5000
 Temp (min / max): -20°C / +80°C
 Humidity (max): <=95% [at 60 deg C / 140 F]
 Vibration: 15 g [10 Hz - 2000 Hz]
 Shock Resistance: 100 g [6 ms]
 Climatical Category: 20/80/21
 Shielding (min): 75 dB (10 MHz)
 Shielding (min): 40 dB (1 GHz)
 Salt Spray Corrosion: >1000 hr
 Pressure: 40 bars

DRAWINGS

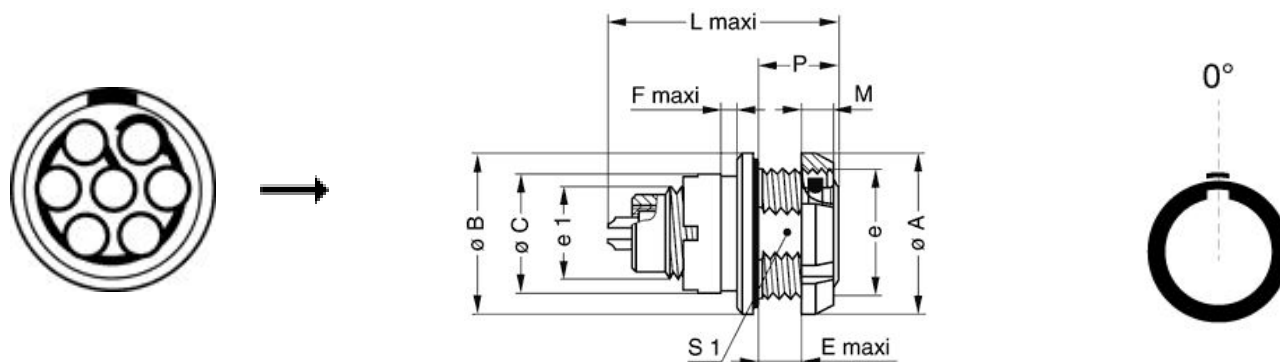

Dimensions

	A	B	C	E	F	L	M	P	S1	e	e1
mm.	24	24	17.5	6.7	1.5	35.6	3.5	11.3	17	M19x1.0	M14x1.0
in.	0,94	0,94	0,69	0,26	0,06	1,40	0,14	0,44	0,67		













RECOMMENDED BY LEMO

LEMO products and services are provided "as is". LEMO makes no warranties or representations with regard to LEMO product & services or use of them, express, implied or statutory, including for accuracy, completeness, or security. The user is fully responsible for his products and applications using LEMO components.

Tools

Spanner wrench: [Socket for torque wrench DCM.2S.M19.6](#)

Cables

CMN.07.T20.062PGZE		Grey	
CMN.07.T20.062PNZE			
CMN.07.T20.062QGZE	TPR (medical)	Grey	
CMN.07.T26.037QGZE	TPR (medical)	Grey	
CMN.07.T28.044PGZE		Grey	
CMN.07.T28.044PNZE			
270250	PVC	Grey	
370500	PVC	Grey	
70140	PVC	Grey	
7041	PVC	Grey	
7050	PVC	Black	
717920	PVC	Grey	
CTR.75.030.121875G	PVC	Grey	

LEMO products and services are provided "as is". LEMO makes no warranties or representations with regard to LEMO product & services or use of them, express, implied or statutory, including for accuracy, completeness, or security. The user is fully responsible for his products and applications using LEMO components.