

Evaluation kit for EiceDRIVER™ 2EDN7524G dual-channel low-side non-isolated gate driver IC KIT_DRIVER_2EDN7524G

[Vincent Chi Zhang \(IFAT PMM ACDC AE\)](#)
[Menditti Matrisciano Carmen \(IFAT PMM ACDC AE\)](#)
[Florian Zechner \(IFAT PMM ACDC AE\)](#)



General description

Introduction

This evaluation kit provides a test platform for Infineon's dual-channel non-isolated gate driver IC EiceDRIVER™ 2EDN7524G in WSON 8pin package.

The complete driving circuitry is integrated into the board to allow a simple and practical step-by-step discovery of the 2EDN7524G characteristic and to evaluate the influence of the surrounding driving circuitry on the signal delivered to the load. The dual-channel driver is intended to feed two low-side MOSFETs in TO-220 package, which can be allocated on the board. For this purpose a CoolMOS™ or OptiMOS™ power MOSFET solution from Infineon can be selected.

The evaluation kit requires an external function generator and a DC power supply to provide the input signals to the 2EDN7524G. As shown in the quick start guide, the easiest and immediate way-to-use the board is with zero-power applied to the MOSFETs. In that operating condition, the 2EDN7524G load is equivalent to a pure RC filter. Testing with different MOSFETs is a suggested option to evaluate and understand the impact of the MOSFETs input capacitance on the driving timing behavior.

Additionally, the possibility to power-up the MOSFETs and then, trigger the switch of the devices, is purposely provided through banana connectors. An external circuitry must be properly built in that case to provide the bulk voltage and limit the current. Furthermore, pads for a possible connection to a daughter card are included.

Summary of features:

- › Complete and easy-to-use solution platform integrating Infineon's 2EDN7524G EiceDRIVER™ gate driver IC and CoolMOS™ or OptiMOS™ power MOSFETs
- › Possible to evaluate the influence of the gate load (R_g or C_{gs}) on the driving behavior of the 2EDN7524G
- › Easy to replace and test different power MOSFETs in TO-220 package

Kit schematic

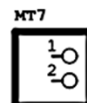
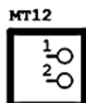
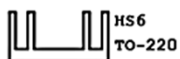
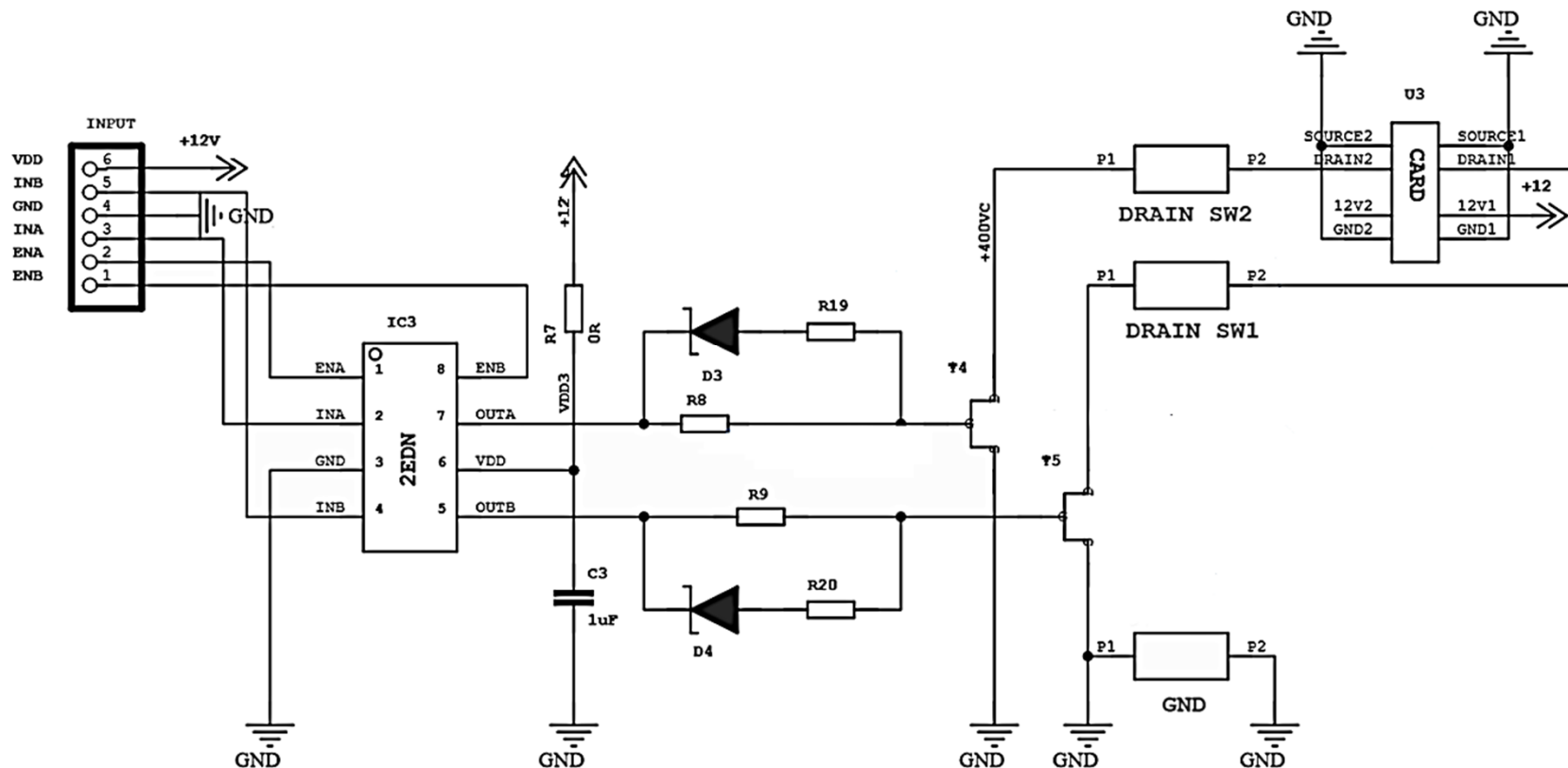

Steps for kit assembly

The following components need to be added to the kit:

- > Distance bolts
- > Source resistors
- > Sink resistors
- > Sink diodes
- > TO-220 sockets
- > TO-220 MOSFETS

Step 1
Distance bolts mounting

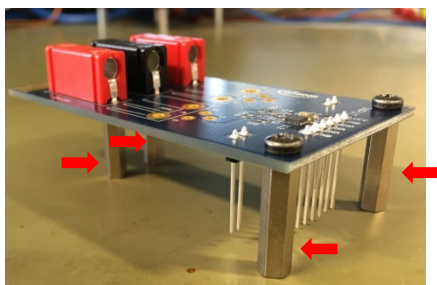

Step 4
TO-220 sockets soldering

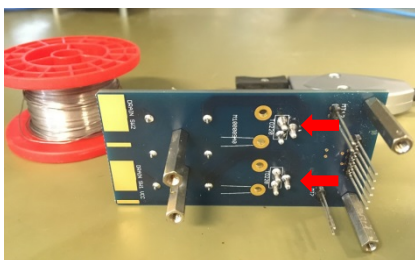

Step 2
Source resistor soldering



Step 5
MOSFETs placement into the sockets

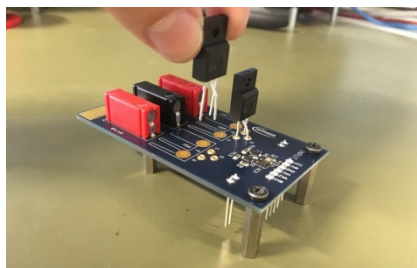

Step 3
Sink resistors and sink diodes soldering

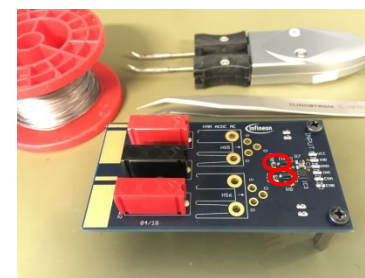

Step 6
Heatsink mounting

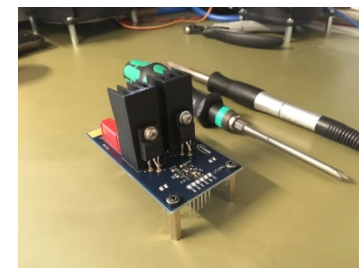

- > For detailed information on how to fully assemble the kit, download the [Quick Start Guide here](#)

Cross reference

Sales_product_name	Gate Driver	Channel	Isolation	Package
KIT_DRIVER_1EDN7511B	1EDN7511B	1	Non-isolated	SOT-23 6pin
KIT_DRIVER_1EDN7512B	1EDN7512B	1	Non-isolated	SOT-23 5pin
KIT_DRIVER_1EDN7512G	1EDN7512G	1	Non-isolated	WSO6 6pin
KIT_DRIVER_1EDN7550B	1EDN7550B /1EDN8550B	1	Non-isolated	SOT-23 6pin
KIT_DRIVER_2EDN7524F	2EDN7524F	2	Non-isolated	DSO 8pin
KIT_DRIVER_2EDN7524R	2EDN7524R	2	Non-isolated	TSSOP 8pin
KIT_DRIVER_2EDN7524G	2EDN7524G	2	Non-isolated	WSO8 8pin
KIT_DRIVER_2EDF7275F	2EDF7275F	2	Functional isolation	NB-DSO-16 150mil
KIT_DRIVER_2EDS8265H	2EDS8265H	2	Reinforced isolation	WB-DSO-16 300mil



Technical Material

- > Application Notes
- > Simulation Models
- > Datasheets
- > PCB Design Data

> www.infineon.com/kit-driver-2edn7524g

Evaluation Boards

- > Evaluation Boards
- > Demoboards
- > Reference Designs

> www.infineon.com/evaluationboards

Videos

- > Technical Videos
- > Product Information Videos

> www.infineon.com/mediacenter

Support Online tools and services



- 1 **Subscribe to Newsletter**
- 2 **Where to Buy**
- 3 **Tools, Finders and Selectors**
- 4 **Support**

- **Products**
 - Applications
 - Tools
 - Support** (4)
 - Technology
- **Power**
 - Automotive System IC
 - ESD & EMI
 - Microcontroller
 - RF & Wireless Control
 - Security IC
 - Sensor
 - Smart Card IC
 - Interface
 - Transistor & Diode
- **Power Overview**
 - Power MOSFET
 - IGBT
 - Smart Low-Side & High-Side Switches
 - Linear Voltage Regulator
 - DC-DC Converter
 - LED Driver | Lighting ICs
 - Silicon Carbide (SiC)
 - High Power Thyristors & Diodes
 - Motor Control & Gate Driver
 - AC-DC Supply

News & Tweets



Part of your life. Part of tomorrow.

