

Features

- Phase Noise: -88/-113dBc/Hz @ 10/100kHz
- Wide Tuning Range
- Low Current Consumption: 120 mA
- Excellent Temperature Stability
- Proven Microphonic Performance
- +5 V Bias
- Lead-Free 5 mm 32-Lead Package
- Halogen-Free “Green” Mold Compound
- RoHS* Compliant and 260°C Reflow Compatible

Description

The MAOC-111100 is a voltage controlled oscillator for frequency generation. No external matching components are required. This VCO is easily integrated into a phase lock loop using the divide-by-two output. The extremely low phase noise makes this part ideal for many radio applications including high capacity digital radios.

The MAOC-111100 primary applications are Point-to-Point Radio, Point-to-Multipoint Radio, Communications Systems, and Low Phase Noise applications.

The 5 mm package has a lead-free finish that is RoHS compliant and compatible with a 260°C reflow temperature. The package features low lead inductance and an excellent thermal path.

Ordering Information¹

Part Number	Package
MAOC-111100-TR0500	500 part Reel
MAOC-111100-TR1000	1000 part Reel
MAOC-111100-001SMB	Sample Board

1. Reference Application Note M513 for reel size information.

* Restrictions on Hazardous Substances,
European Union Directive 2011/65/EU.

Block Diagram

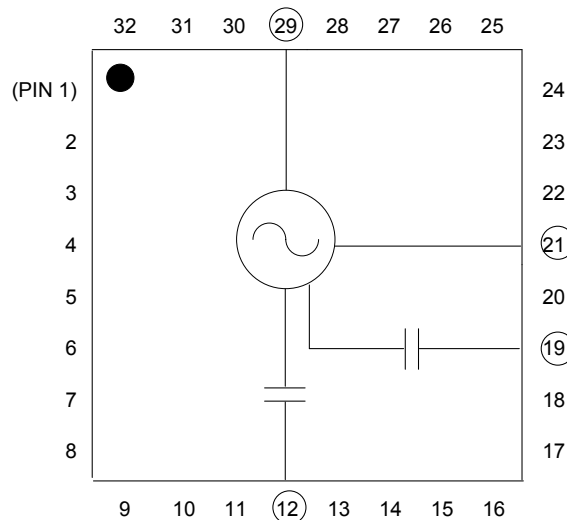

Pin Configuration²

Pin	Function
1 - 11	N/C
12	RF/2
13 - 18	N/C
19	RF
20	N/C
21	V _{CC}
22 - 28	N/C
29	V _{TUNE}
30 - 32	N/C
33 ³	GND

2. MACOM recommends connecting unused package pins to ground.
3. The exposed pad centered on the package bottom must be connected to RF, DC and thermal ground.

Broadband Voltage Controlled Oscillator 10.8 - 11.415 GHz

Rev. V1

Electrical Specifications: $T_A = +25^\circ\text{C}$, $V_{CC} = 5.0\text{ V}^4$, $Z_0 = 50\ \Omega$

Parameter	Test Conditions	Units	Min.	Typ.	Max.
Output Power	RF Port, 10.8 - 11.415 GHz RF/2 Port, 5.4 - 5.7075 GHz	dBm	5 -1	11 4	—
SSB Phase Noise	RF Port, 10 kHz Offset, 10.8 - 11.415 GHz RF Port, 100 kHz Offset, 10.8 - 11.415 GHz	dBc/Hz	—	-88 -113	— -108
Harmonics/Subharmonics $V_{CC} = V_{TUNE} = 5\text{ V}$	RF Port, $\frac{1}{2} F_0$ RF Port, $2 F_0$	dBc	—	-35 -39	—
Pulling (Sensitivity to Match) $V_{CC} = V_{TUNE} = 5\text{ V}$	RF Port, VSWR = 1.95:1 to 2.25:1	MHz pk-pk	—	10	—
Pushing (Sensitivity to Supply Voltage)	RF Port, $V_{TUNE} = 5\text{ V}$ RF/2 Port, $V_{TUNE} = 5\text{ V}$	MHz/V	—	20 10	—
Frequency Drift Rate (Sensitivity to Temperature)	RF Port, 10.8 - 11.415 GHz RF/2 Port, 5.4 - 5.7075 GHz	MHz/ $^\circ\text{C}$	—	1.2 0.6	—
Output Return Loss	RF Port, 10.8 - 11.415 GHz RF/2 Port, 5.4 - 5.7075 GHz	dB	—	6 25	—
Tuning Sensitivity @ RF Port	$V_{TUNE} = 5\text{ V}$	GHz/V	—	0.13	—
Supply Current	I_{CC}	mA	—	120	150
Tune Voltage	V_{TUNE}	V	1.5	—	12.5
Tuning Current Leakage	$V_{TUNE} = 13\text{ V}$	μA	—	5	—

4. VCO can operate over the 4.75 V to 5.25 V supply voltage range.

Absolute Maximum Ratings ^{5,6,7}

Parameter	Absolute Maximum
Voltage	5.5 Vdc
V_{TUNE}	0 to 15 Vdc
Storage Temperature	-55 $^\circ\text{C}$ to +150 $^\circ\text{C}$
Operating Temperature	-40 $^\circ\text{C}$ to +85 $^\circ\text{C}$
Junction Temperature ⁸	+150 $^\circ\text{C}$

- Exceeding any one or combination of these limits may cause permanent damage to this device.
- MACOM does not recommend sustained operation near these survivability limits.
- Operating at nominal conditions with $T_J \leq +150^\circ\text{C}$ will ensure MTBF > 1×10^6 hours.
- Junction Temperature (T_J) = $T_C + \Theta_{jc} * (V * I)$
Typical thermal resistance (Θ_{jc}) = 58 $^\circ\text{C/W}$.
 - For $T_C = 25^\circ\text{C}$, $T_J = 59^\circ\text{C}$ @ 5 V, 118 mA
 - For $T_C = 85^\circ\text{C}$, $T_J = 120^\circ\text{C}$ @ 5 V, 120 mA

Handling Procedures

Please observe the following precautions to avoid damage:

Static Sensitivity

These electronic devices are sensitive to electrostatic discharge (ESD) and can be damaged by static electricity. Proper ESD control techniques should be used when handling these HBM Class 1B devices.



ESD Rating: Class 1B

Broadband Voltage Controlled Oscillator 10.8 - 11.415 GHz

Rev. V1

Typical Performance Curves: $V_{CC} = 5\text{ V}$, $T_A = +25^\circ\text{C}$ (unless otherwise indicated)

Output Frequency vs. Tune Voltage - RF Port

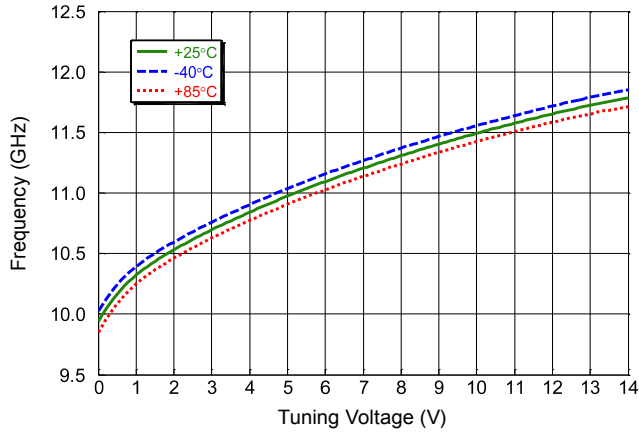

Output Frequency vs. Tune Voltage - RF/2 Port

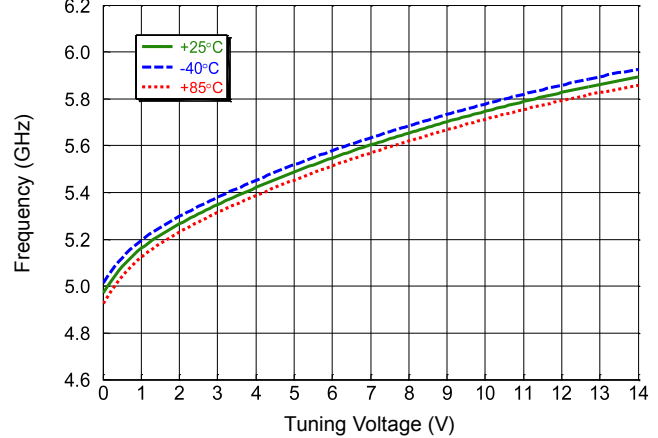

Output Frequency vs. Tuning / Supply Voltage - RF Port

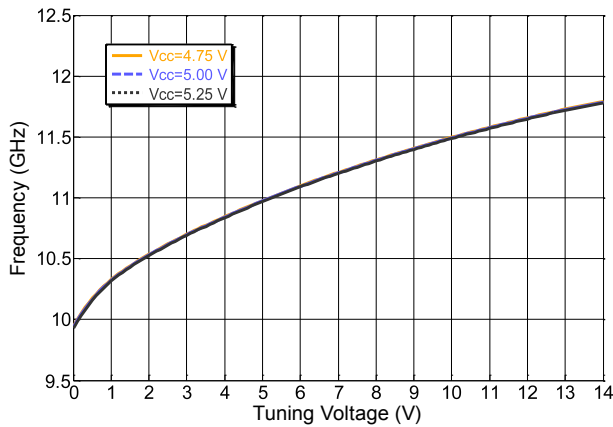

Output Frequency vs. Tuning / Supply Voltage - RF/2 Port

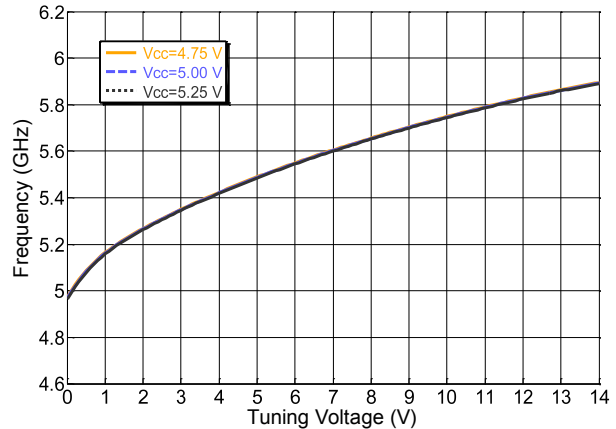

Output Power vs. Tuning Voltage - RF Port

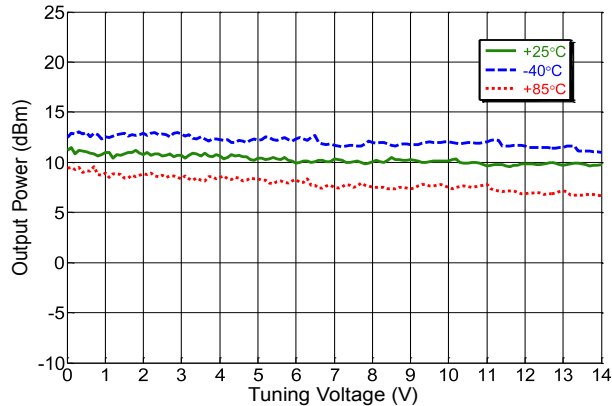

Output Power vs. Tuning Voltage - RF/2 Port

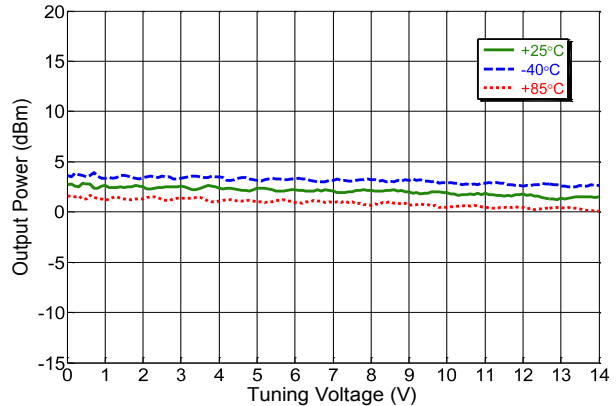

Broadband Voltage Controlled Oscillator 10.8 - 11.415 GHz

Rev. V1

Typical Performance Curves: $V_{CC} = 5\text{ V}$, $T_A = +25^\circ\text{C}$ (unless otherwise indicated)

Frequency Sensitivity vs. Tuning Voltage - RF Port

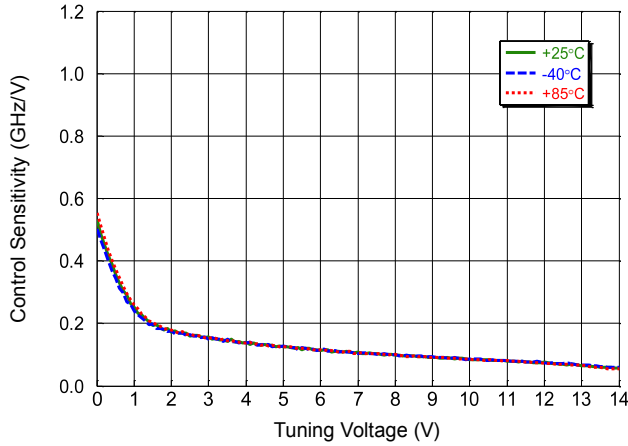

Frequency Sensitivity vs. Tuning Voltage - RF/2 Port

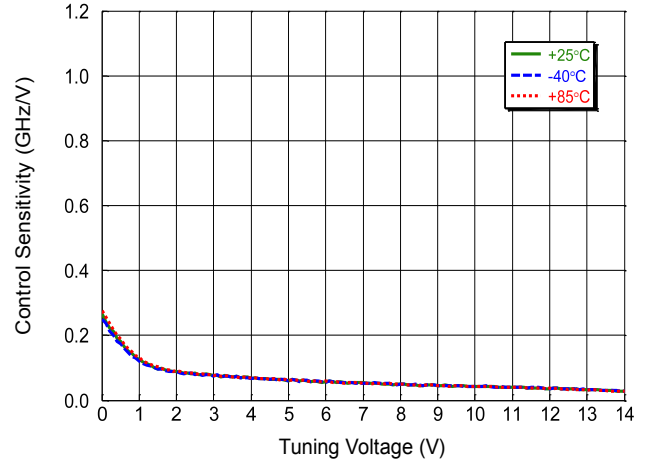

Single Side Band Phase Noise vs. Tuning Voltage - RF port

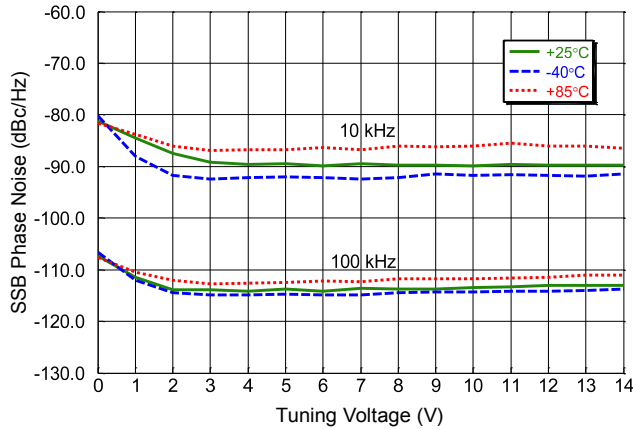

Single Side Band Phase Noise vs. Frequency Offset - RF Port ($V_{TUNE} = 5\text{V}$)

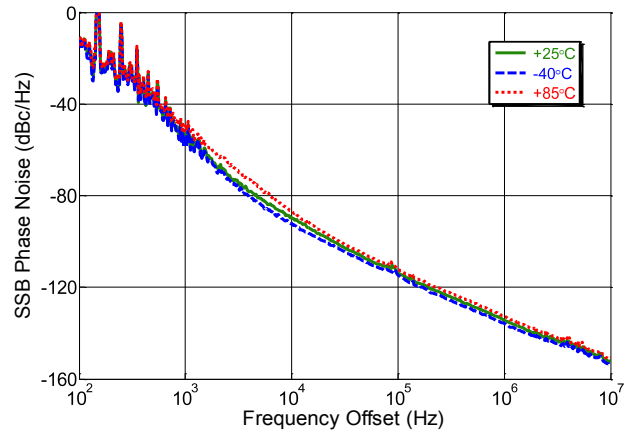

Sample Board

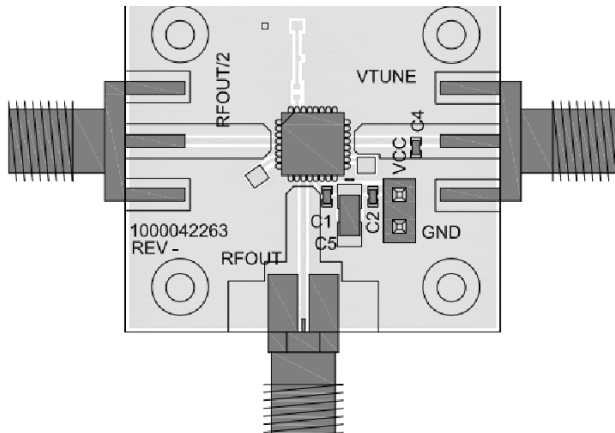

Parts List

Component	Value	Case Size
C1	100 pF	0402
C2, C4	0.1 μ F	0402
C5	10 μ F Tantalum	1206

Lead-Free 5 mm 32-Lead PQFN[†]

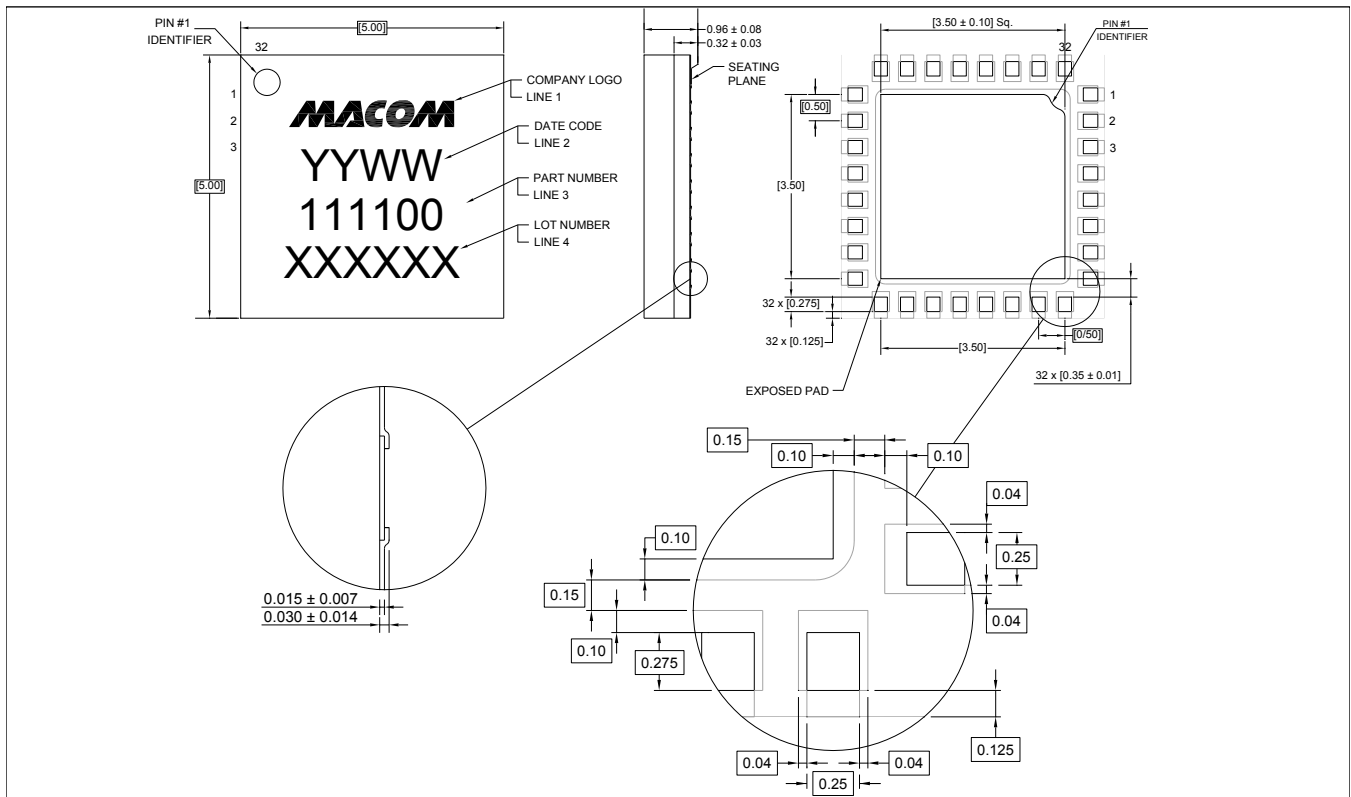

[†] Reference Application Note S2083 for lead-free solder reflow recommendations.
Meets JEDEC moisture sensitivity level 3 requirements.
Plating is ENEPIG over copper.

MACOM Technology Solutions Inc. All rights reserved.

Information in this document is provided in connection with MACOM Technology Solutions Inc ("MACOM") products. These materials are provided by MACOM as a service to its customers and may be used for informational purposes only. Except as provided in MACOM's Terms and Conditions of Sale for such products or in any separate agreement related to this document, MACOM assumes no liability whatsoever. MACOM assumes no responsibility for errors or omissions in these materials. MACOM may make changes to specifications and product descriptions at any time, without notice. MACOM makes no commitment to update the information and shall have no responsibility whatsoever for conflicts or incompatibilities arising from future changes to its specifications and product descriptions. No license, express or implied, by estoppels or otherwise, to any intellectual property rights is granted by this document.

THESE MATERIALS ARE PROVIDED "AS IS" WITHOUT WARRANTY OF ANY KIND, EITHER EXPRESS OR IMPLIED, RELATING TO SALE AND/OR USE OF MACOM PRODUCTS INCLUDING LIABILITY OR WARRANTIES RELATING TO FITNESS FOR A PARTICULAR PURPOSE, CONSEQUENTIAL OR INCIDENTAL DAMAGES, MERCHANTABILITY, OR INFRINGEMENT OF ANY PATENT, COPYRIGHT OR OTHER INTELLECTUAL PROPERTY RIGHT. MACOM FURTHER DOES NOT WARRANT THE ACCURACY OR COMPLETENESS OF THE INFORMATION, TEXT, GRAPHICS OR OTHER ITEMS CONTAINED WITHIN THESE MATERIALS. MACOM SHALL NOT BE LIABLE FOR ANY SPECIAL, INDIRECT, INCIDENTAL, OR CONSEQUENTIAL DAMAGES, INCLUDING WITHOUT LIMITATION, LOST REVENUES OR LOST PROFITS, WHICH MAY RESULT FROM THE USE OF THESE MATERIALS.

MACOM products are not intended for use in medical, lifesaving or life sustaining applications. MACOM customers using or selling MACOM products for use in such applications do so at their own risk and agree to fully indemnify MACOM for any damages resulting from such improper use or sale.