

## Constant Current LED Driver with PWM Dimming Control

### ■ GENERAL DESCRIPTION

The NJW4615A is a constant current LED driver with PWM dimming control. The output current can be set by external sensing resistor, and the NJW4615A can set up to 100mA.

Because the withstand voltage of the output (LED) pin is 35V, it can series-connect the LED depending on forward voltage of the LED.

The LED dimming control can be regulated via PWM duty cycle. It is suitable for back light, light source and so on.

### ■ PACKAGE OUTLINE

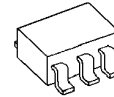

NJW4615AF1  
(SOT-23-6-1)

### ■ FEATURES

- Supply Voltage Range      2.5V to 35V
- Output Voltage               $V_{LED} = 35V$  max.
- Output Current               $I_{LED} = 5mA$  to 100mA
- Output Current Accuracy     $\pm 1.2\%$
- To 10 of White LED can be operated. (at LED Vf=3.2V)
- Quiescent Current          370 $\mu$ A max.
- PWM Dimming Control
- Enable Function
- Over Current Protection (with Hysteresis)
- Thermal Shutdown Protection
- LED Short Protection
- Package                      SOT-23-6-1

### ■ BLOCK DIAGRAM

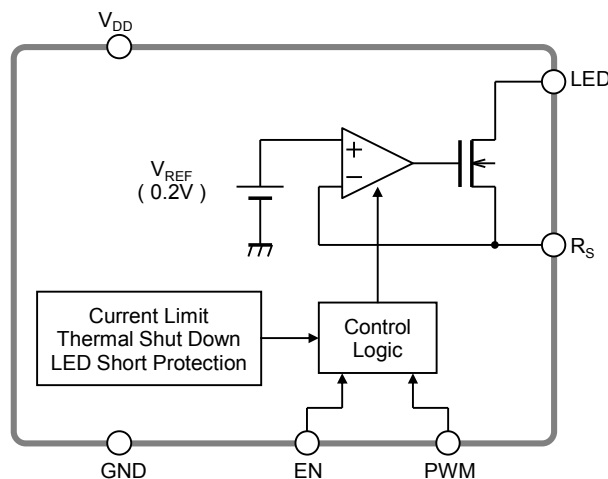

# NJW4615A

## ■ PIN CONFIGURATION

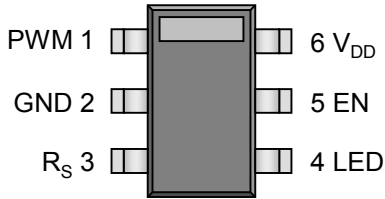

## ■ PIN DESCRIPTIONS

Pin No.	Pin Name	I/O	Function
1	PWM	I	PWM signal input pin for dimming control. The LED dimming control can be regulated by PWM duty cycle. When this pin is open or input High level, $I_{LED}$ becomes set current by an external resistor ( $R_S$ ).
2	GND	-	Ground pin
3	$R_S$	O	Resistor connect pin of $I_{LED}$ setting. The LED current can be set with connected resistor ( $R_S$ ) between $R_S$ pin and GND pin. $R_S [\Omega] = 0.2 [V] / I_{LED} [A]$
4	LED	O	Constant current circuit output pin Connect cathode pin of LED.
5	EN	I	Standby control pin Normal operation: High Level. Standby mode: Low Level.
6	$V_{DD}$	-	Power supply pin

## ■ ABSOLUTE MAXIMUM RATINGS

(Ta=25°C)

PARAMETER	SYMBOL	RATINGS	UNIT
Supply Voltage	V <sub>DD</sub>	-0.3 to +40	V
Output Voltage	V <sub>LED</sub>	-0.3 to +40	V
EN Pin Voltage	V <sub>EN</sub>	-0.3 to +40	V
PWM Pin Voltage	V <sub>PWM</sub>	-0.3 to +6	V
Power Dissipation	P <sub>D</sub>	510 (*1) 710 (*2)	mW
Junction Temperature Range	T <sub>J</sub>	-40 to +150	°C
Operating Temperature Range	T <sub>opr</sub>	-40 to +125	°C
Storage Temperature Range	T <sub>stg</sub>	-50 to +150	°C

(\*1) Mounted on glass epoxy board based on EIA/JEDEC. (76.2 × 114.3 × 1.6mm: 2Layers FR-4)

(\*2) Mounted on glass epoxy board based on EIA/JEDEC. (76.2 × 114.3 × 1.6mm: 4Layers FR-4), Internal Cu area: 74.2 × 74.2mm

## ■ RECOMMENDED OPERATING CONDITIONS

PARAMETER	SYMBOL	TEST CONDITIONS	MIN.	TYP.	MAX.	UNIT
Supply Voltage	V <sub>DD</sub>		2.5	-	35	V
Output Current	I <sub>LED</sub>		5	-	100	mA
Output Voltage	V <sub>LED</sub>		-	-	35	V

## ■ ELECTRICAL CHARACTERISTICS

(Unless otherwise noted, V<sub>DD</sub> = V<sub>EN</sub> = 12V, V<sub>LED</sub> = 1V, R<sub>S</sub> = 10Ω, V<sub>PWM</sub> = OPEN, Ta = 25°C)

PARAMETER	SYMBOL	TEST CONDITIONS	MIN.	TYP.	MAX.	UNIT
Quiescent Current	I <sub>DD</sub>		-	260	370	μA
Quiescent Current at OFF State	I <sub>DD OFF</sub>	V <sub>EN</sub> = GND	-	-	0.1	μA
Output Current Accuracy	ΔI <sub>LED</sub>		-1.2	-	+1.2	%
Output (LED) Pin Leak Current 1	I <sub>LEAK1</sub>	V <sub>EN</sub> = GND, V <sub>DD</sub> = 35V, V <sub>LED</sub> = 35V	-	-	0.1	μA
Output (LED) Pin Leak Current 2	I <sub>LEAK2</sub>	V <sub>PWM</sub> = GND V <sub>DD</sub> = 35V, V <sub>LED</sub> = 35V	-	-	0.1	μA
EN Pin ON Voltage	V <sub>EN ON</sub>	I <sub>LED</sub> = OFF → ON	1.6	-	V <sub>DD</sub>	V
EN Pin OFF Voltage	V <sub>EN OFF</sub>	I <sub>LED</sub> = ON → OFF	0	-	0.3	V
PWM Pin ON Voltage 1	V <sub>PWM ON 1</sub>	V <sub>DD</sub> < 5V, I <sub>LED</sub> = OFF → ON	0.7V <sub>DD</sub>	-	V <sub>DD</sub>	V
PWM Pin OFF Voltage 1	V <sub>PWM OFF 1</sub>	V <sub>DD</sub> < 5V, I <sub>LED</sub> = ON → OFF	0	-	0.3V <sub>DD</sub>	V
PWM Pin ON Voltage 2	V <sub>PWM ON 2</sub>	V <sub>DD</sub> ≥ 5V, I <sub>LED</sub> = OFF → ON	3.5	-	5.5	V
PWM Pin OFF Voltage 2	V <sub>PWM OFF 2</sub>	V <sub>DD</sub> ≥ 5V, I <sub>LED</sub> = ON → OFF	0	-	1.5	V
EN Pin Input Current	I <sub>EN</sub>	V <sub>EN</sub> = 12V	-	7	-	μA
PWM Pin Pull Up Resistance	R <sub>PWM</sub>		-	1	-	MΩ
R <sub>S</sub> Pin Output Current	I <sub>OUT RS</sub>	LED = OPEN	-	2.3	-	μA
PWM Pin ON Delay Time	t <sub>PWM ON</sub>	V <sub>PWM</sub> = L → H, I <sub>LED</sub> = OFF → ON	-	3	-	μs
PWM Pin OFF Delay Time	t <sub>PWM OFF</sub>	V <sub>PWM</sub> = H → L, I <sub>LED</sub> = ON → OFF	-	1	-	μs
LED Short Protection Detect Voltage	V <sub>LED_SHORT</sub>		17	20	23	V
Maximum Output Current	I <sub>LED MAX</sub>	R <sub>S</sub> = 0 Ω	100	170	-	mA

# NJW4615A

## ■ TYPICAL APPLICATIONS

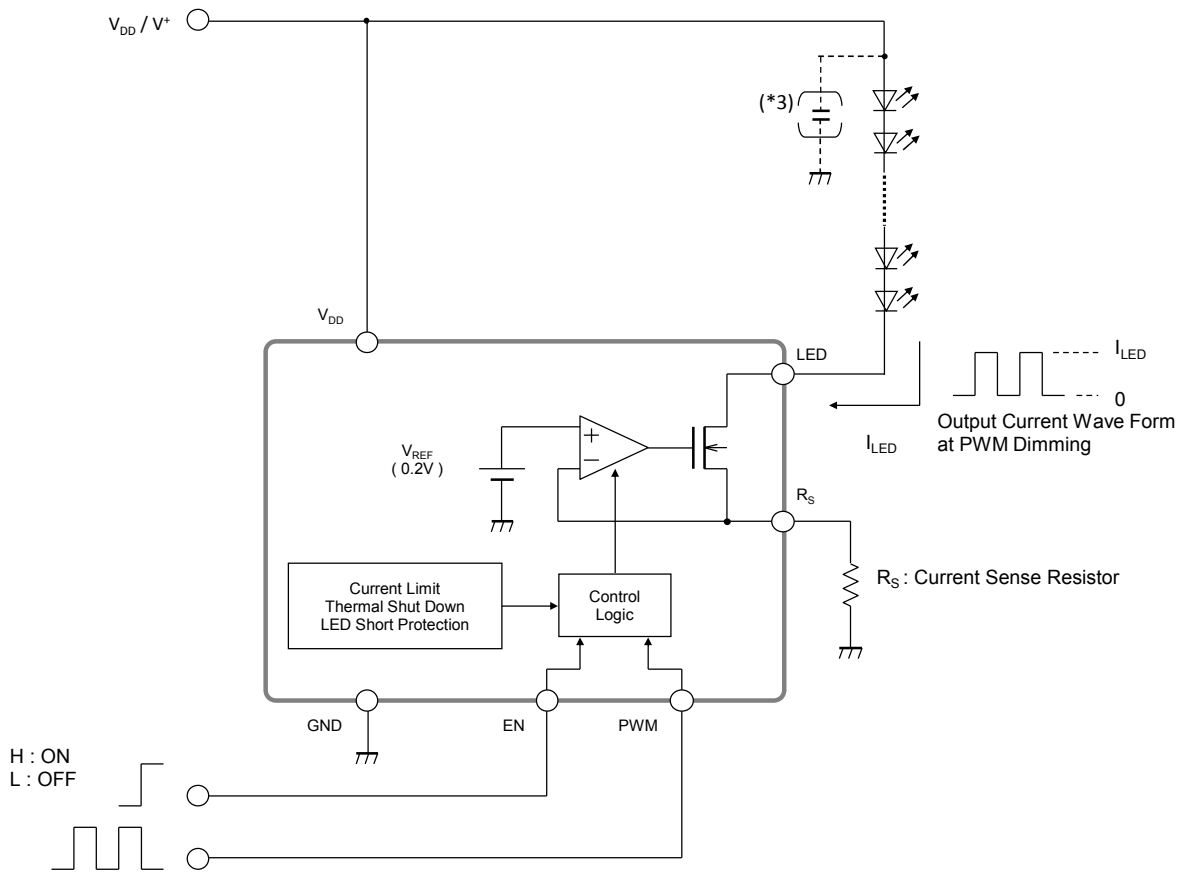

The  $R_S$  Resistance Setting formula: 
$$R_S(\Omega) = \frac{0.2(V)}{I_{LED}(A)}$$

(\*3) If the wiring from the power supply to the LED anode pin is long, the voltage may change due to the influence of the parasitic elements.

As the countermeasure, it should connect a decoupling capacitor as close to the LED as possible.

## ■ TYPICAL CHARACTERISTICS

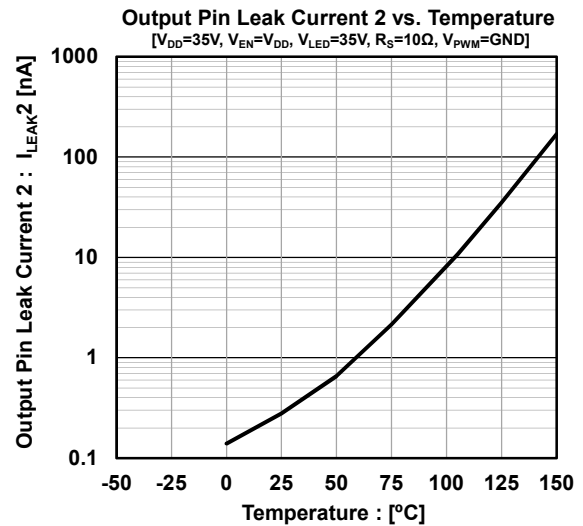
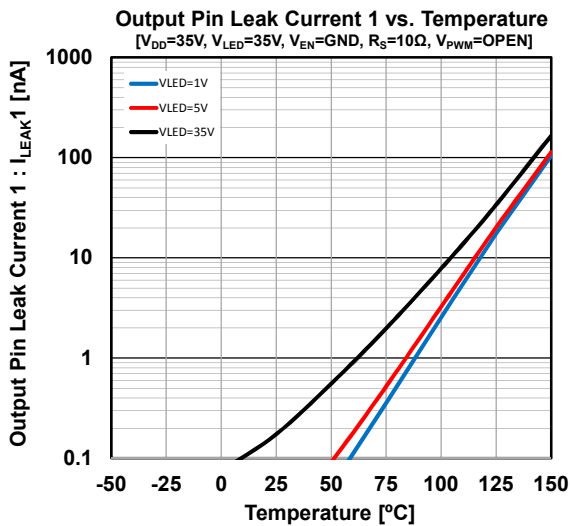
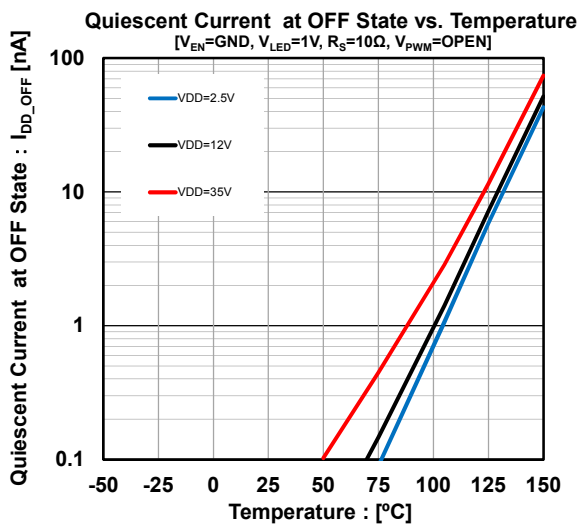
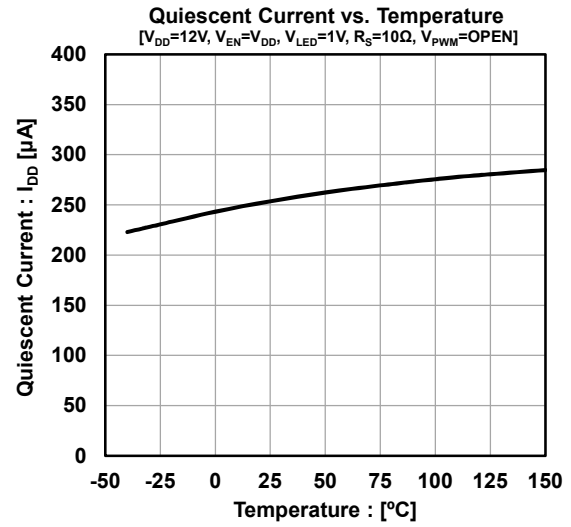
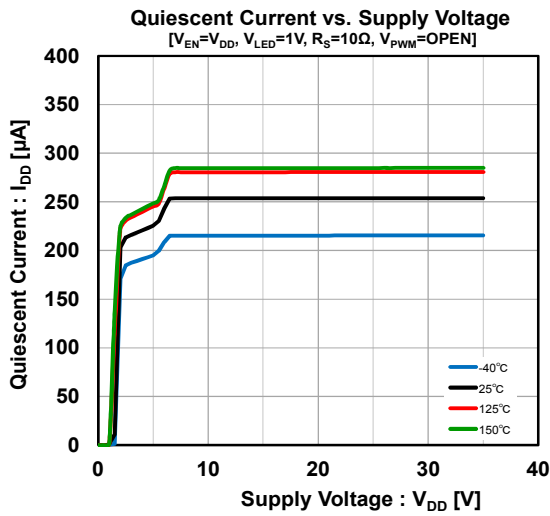

# NJW4615A

## ■ TYPICAL CHARACTERISTICS

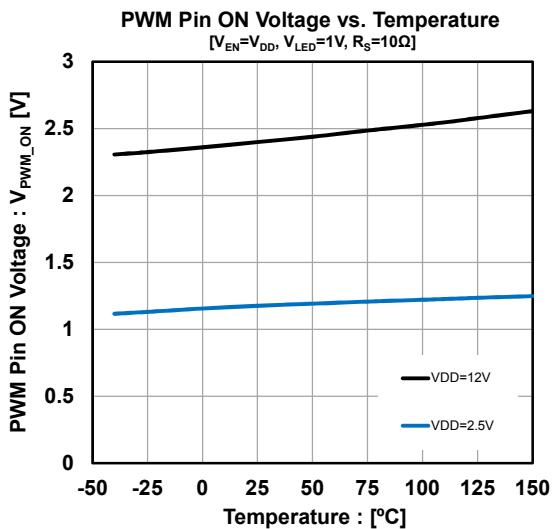
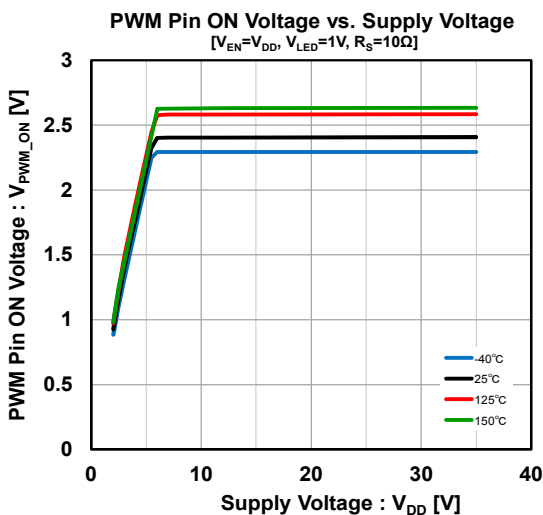
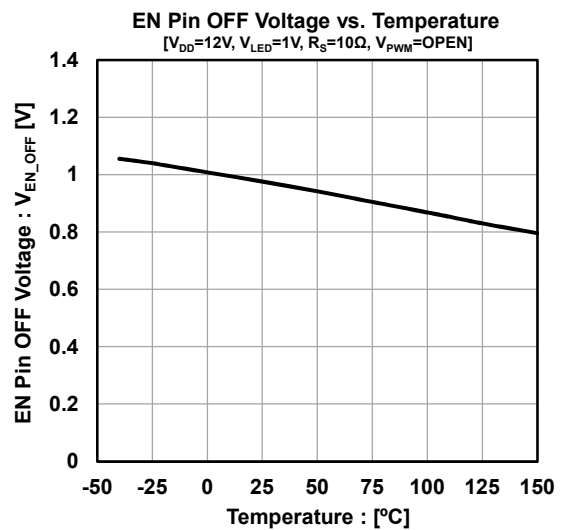
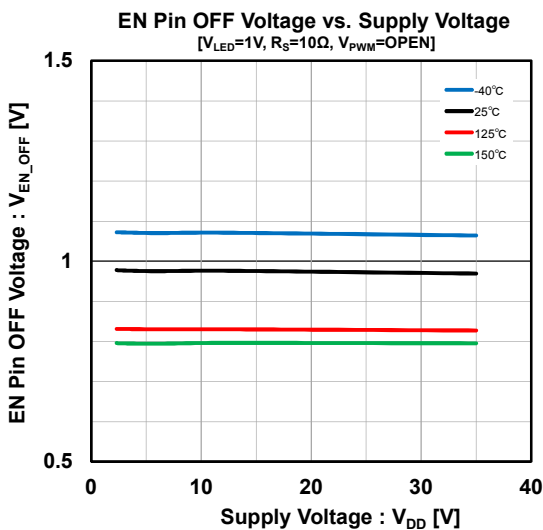
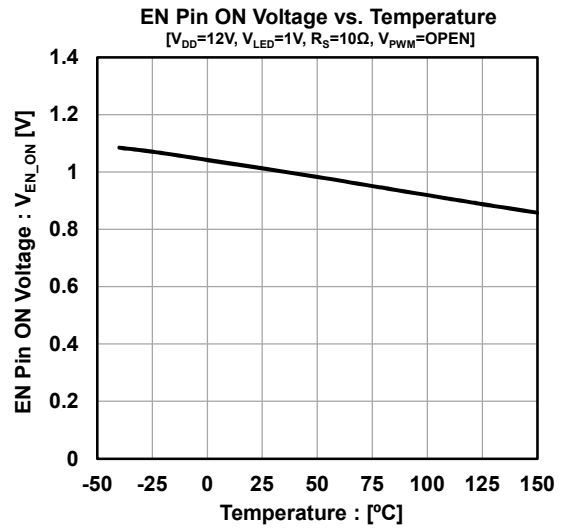
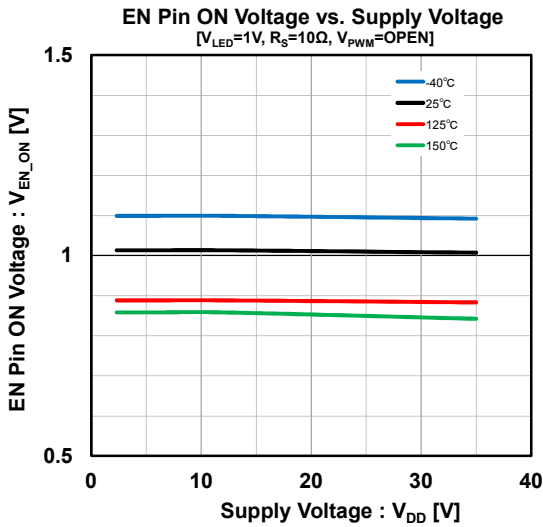

## ■ TYPICAL CHARACTERISTICS

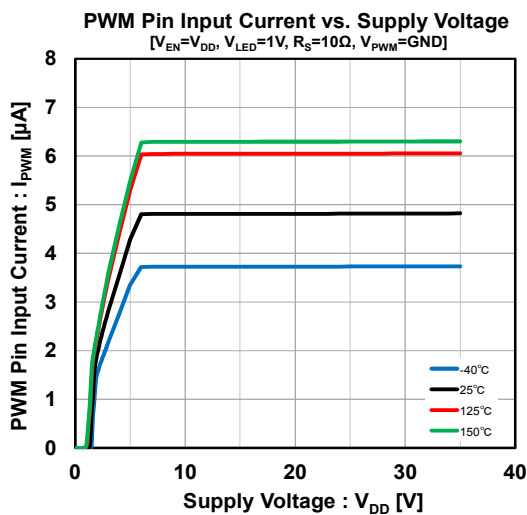
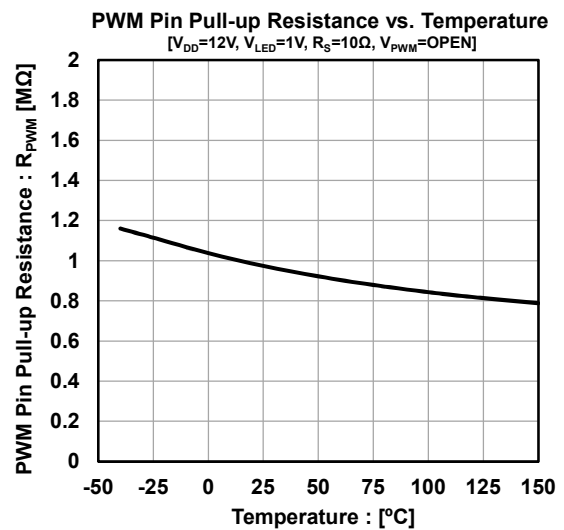
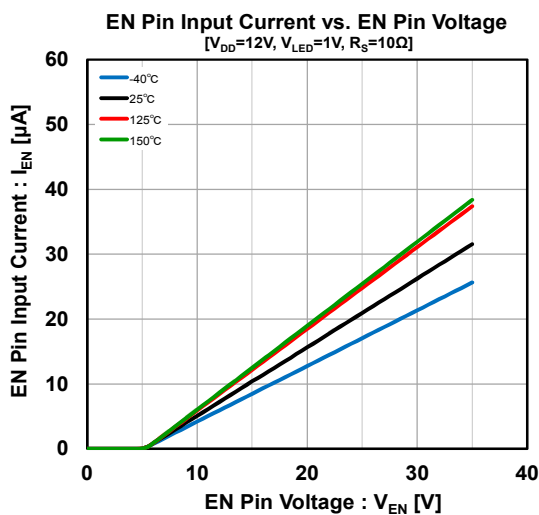
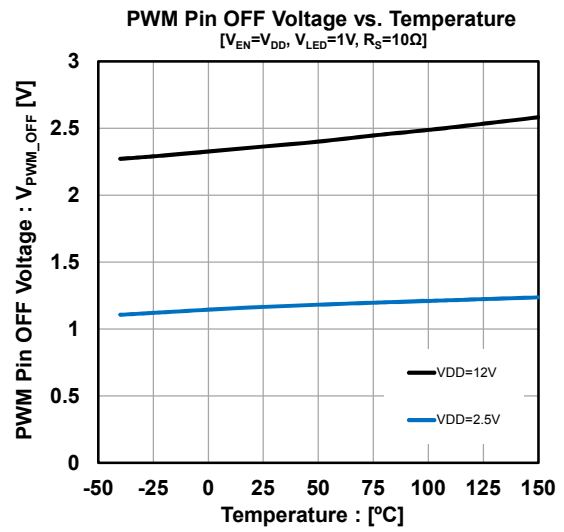
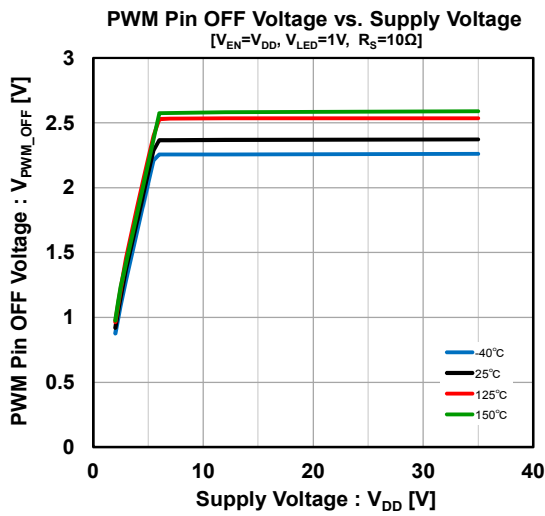

# NJW4615A

## ■ TYPICAL CHARACTERISTICS

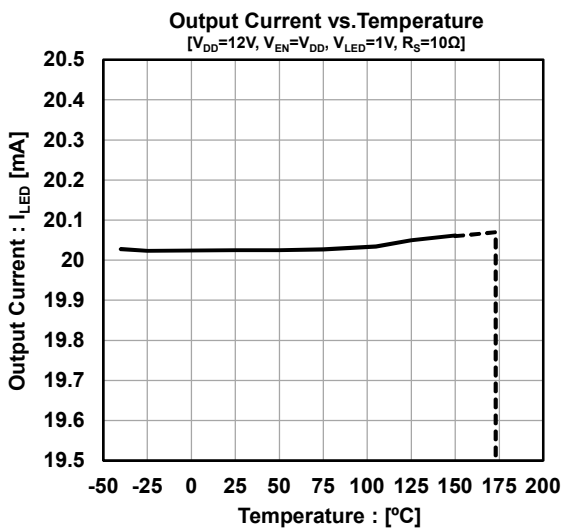
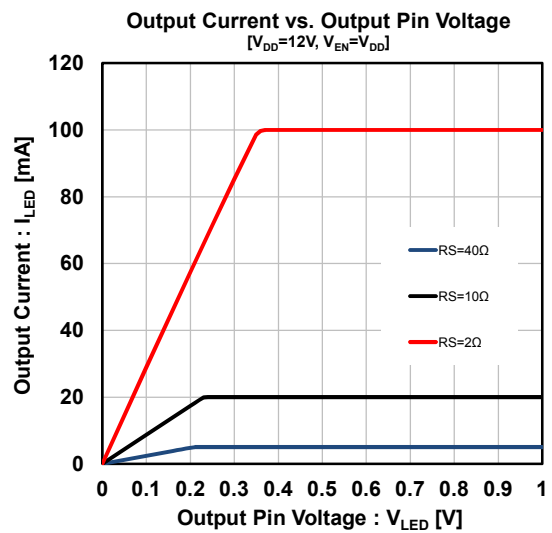
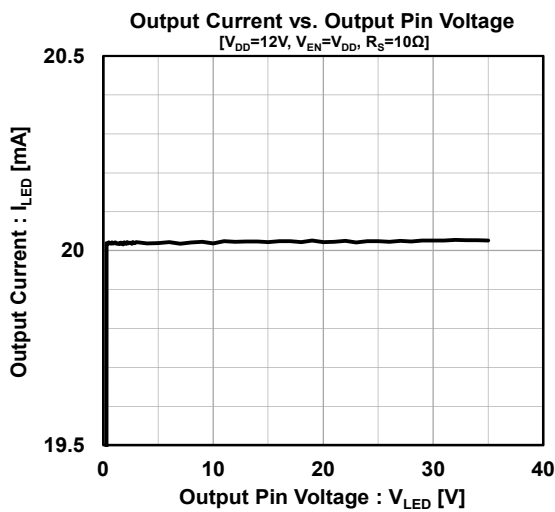
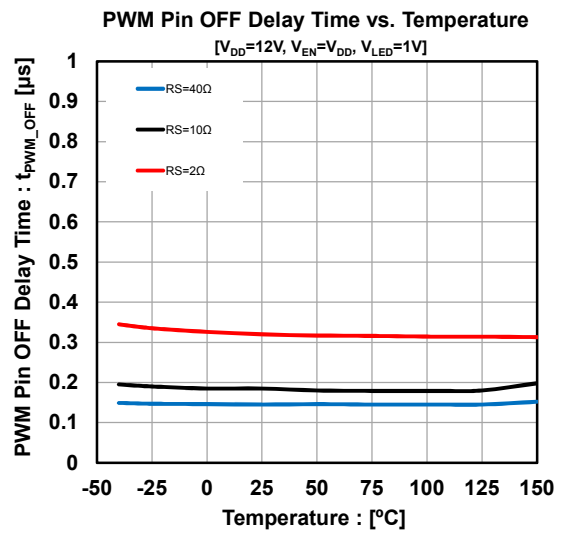
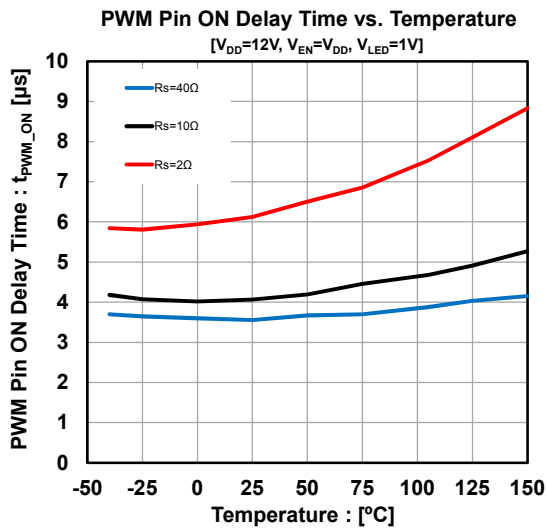



## ■ TYPICAL CHARACTERISTICS

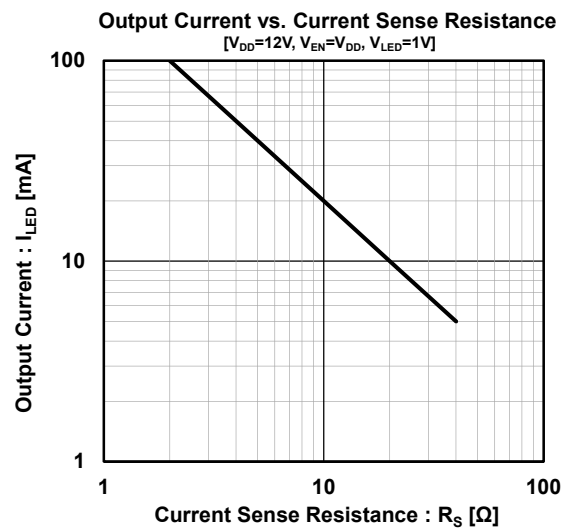
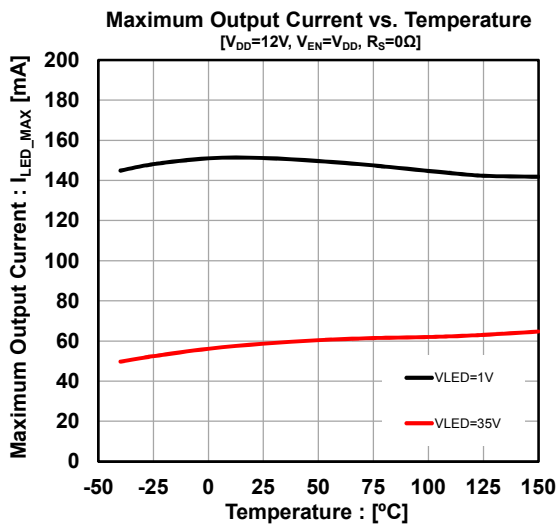
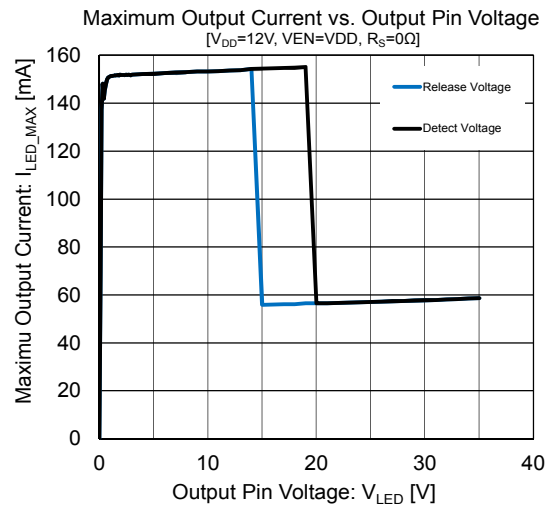
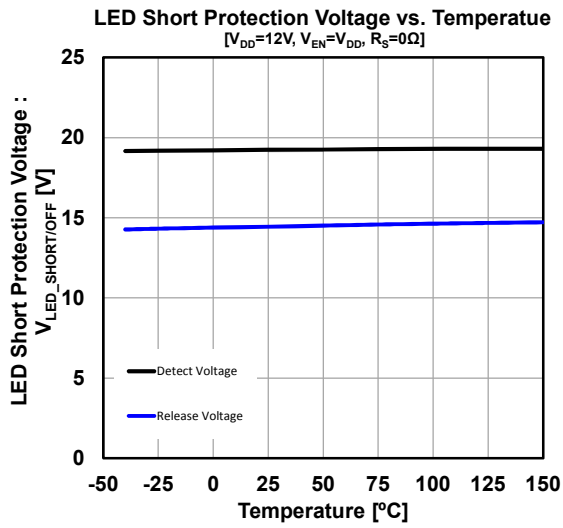

■ The number of LED series connection

It is necessary to drive LED that is the LED forward voltage ( $V_f$ ) or more.  
 When the LED was series connected, the supply voltage should be input sum of LED  $V_f$  ( $\Sigma LED V_f$ ) the series connected or more. In NJW4615A, it is necessary as minimum  $V^+$  that is  $\Sigma LED V_f + NJW4615A$  output voltage ( $V_{LED} = 1V$ ). The maximum LED connected number that NJW4615A can drive is limited by the recommended output voltage maximum value (35V). Moreover, it should be used with  $\Sigma LED V_f$  within 34V that is subtracted the  $V_{LED} = 1V$ .

The table below shows maximum LED number at each  $V_f$ . (All LED  $V_f$  assumes ideally same)

LED $V_f$ is up to 3.0V	...	up to 11 lights
LED $V_f$ is up to 3.2V	...	up to 10 lights
LED $V_f$ is up to 3.7V	...	up to 9 lights
LED $V_f$ is up to 4.2V	...	up to 8 lights

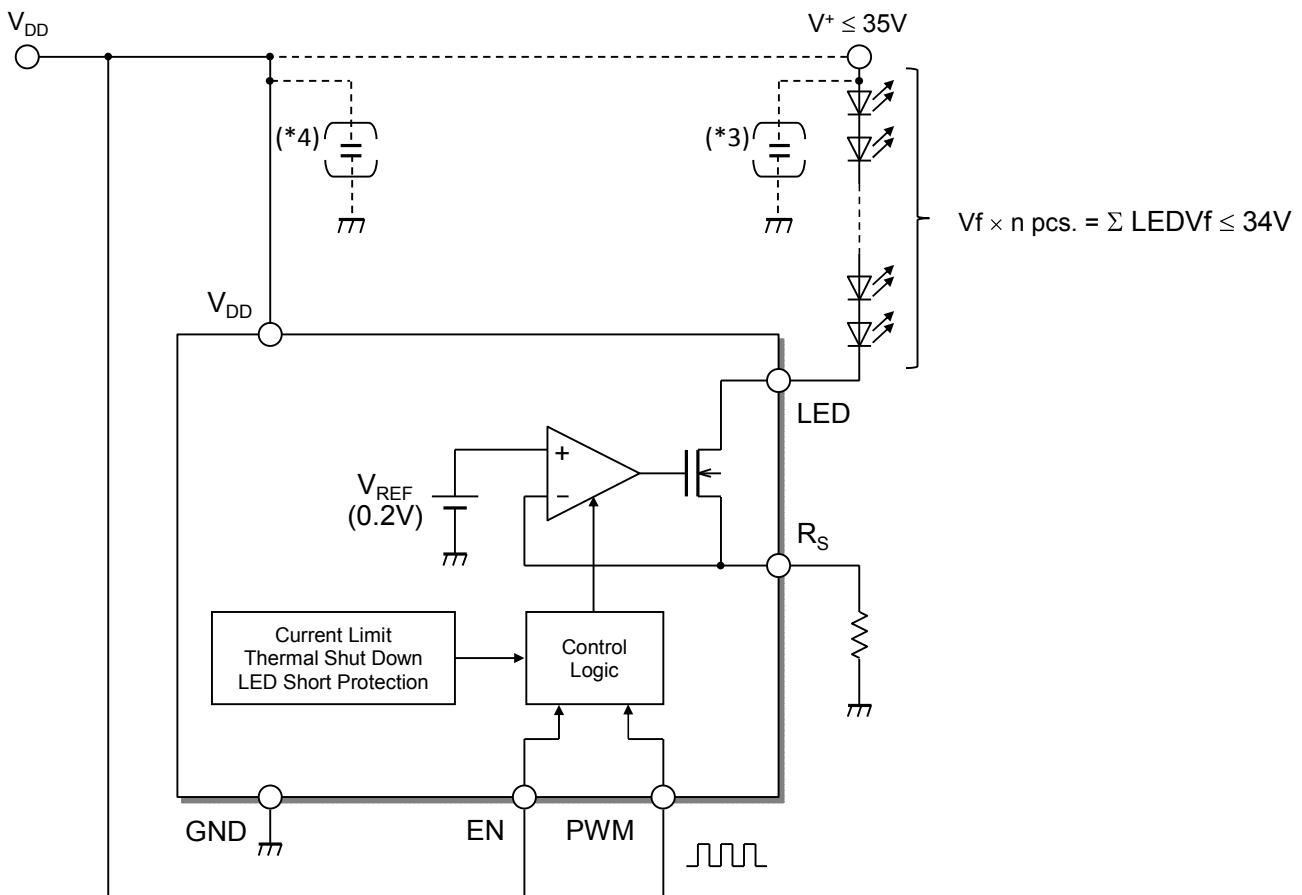

(\*4) If the wiring from the power supply to the  $V_{DD}$  pin is long, the voltage may change due to the influence of the parasitic elements.

As the countermeasure, it should connect a decoupling capacitor as close to the  $V_{DD}$  pin as possible.

## Application Manual

### ■ PWM input pulse and PWM dimming accuracy

The  $I_{LED}$  transient behavior corresponding to PWM input pulse has some delay at rise/fall time.

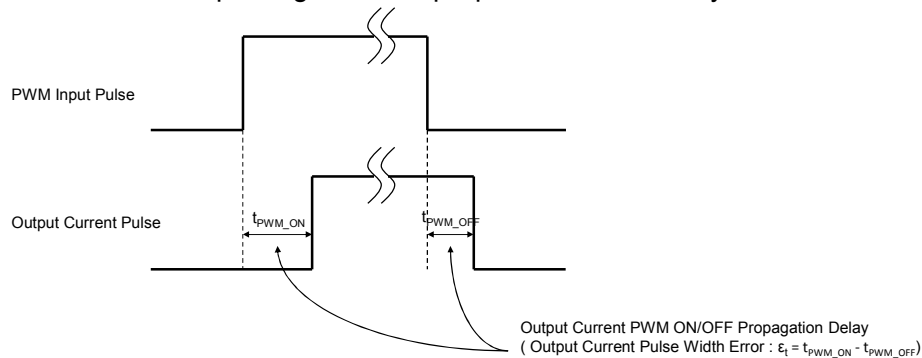

If enter a PWM signal with short pulse width, for the output current pulse width error becomes larger against the PWM input pulse width, it is incapable of accurate PWM dimming. The Output current pulse width error rate ( $\epsilon_t$ ) becomes the following value. (  $\epsilon_t = t_{PWM\_ON} - t_{PWM\_OFF}$  )

$$\epsilon_t = \text{approx. } 2\mu\text{s} \quad (\text{Output Current: } I_{LED}=20\text{mA}, T_a=25^\circ\text{C typ. <Reference Value> } )$$

The actual value of the output current pulse width error rate can calculate by above error rate ( $\epsilon_t$ ) and the frequency and Duty of the PWM input pulse. ( $f_{PWM}$ : PWM input pulse frequency, D: PWM input pulse Duty)  
Based on the allowable value of the output current pulse width error rate, you should determine the frequency and Duty of the PWM input pulse.

$$\begin{aligned} \text{PWM Input pulse width} &= D / 100 \times ( 1 / f_{PWM} ) \\ \text{Output Current pulse width} &= \text{PWM Input pulse width} - \epsilon_t \\ \text{Output Current pulse width error rate} &= (\text{Output Current pulse width} - \text{PWM Input pulse width}) / \text{PWM Input pulse width} \times 100 \\ &= -\epsilon_t / \text{PWM Input pulse width} \times 100 [\%] \end{aligned}$$

【 Output current pulse width error rate calculation example:

operation with PWM input pulse frequency 200Hz and Duty1% 】

$$\begin{aligned} \text{PWM Input pulse width} &= 1 [\%] / 100 \times ( 1 / 200[\text{Hz}] ) = 50 [\mu\text{s}] \\ \text{Output Current pulse width error rate} &= -2 [\mu\text{s}] / 50 [\mu\text{s}] \times 100 \\ &= -4 [\%] \end{aligned}$$

Output Current Duty vs. PWM Input Pulse Duty

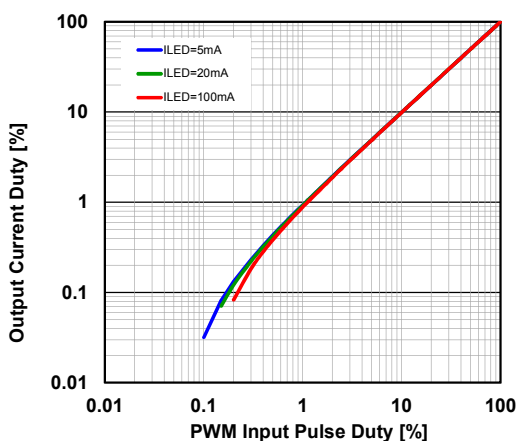

【 Measurement Conditions 】

Output Current ( $I_{LED}$ )	5mA	( $R_S = 40\Omega$ )
	20mA	( $R_S = 10\Omega$ )
	100mA	( $R_S = 2\Omega$ )
Supply Voltage	12V	
Output (LED) pin	Input Voltage at 1V	
PWM Input Pulse	200Hz, 0 to 5V	
Output Current $I_{LED}$ Pulse Width	The time is more than 90% of set current.	
Ambient Temperature	$T_a = 25^\circ\text{C}$	

### ■ Protection Circuit

#### ▪ Over Current Protection (Refer to Maximum Output Current vs. Output Pin Voltage)

This protection function limits the output current, when the RS pin and GND pin was shorted. The limited current is dependence on output (LED) pin voltage.

When the output (LED) pin voltage is less than "LED Short Protection Detect Voltage", maximum output current is limited to approx. 170mA (output (LED) pin voltage=1V, Ta=25°C).

The output current returns to set current, when the short status is release.

#### ▪ LED Short Protection (Refer to Maximum Output Current vs. Output Pin Voltage)

This protection function limits the output current, when the output (LED) pin rises as in LED shorten at output FET ON.

The output current is limited to approx. 60mA when the output (LED) pin voltage rose to approx. 20V.

#### ▪ Thermal Shutdown Function (Refer to Output Current vs. Temperature)

When junction temperature of the NJW4615A exceeds the 170°C\*, internal thermal shutdown circuit function stops the device function. When junction temperature decreases to 150°C\* or less, the device operation returns to normal operation.

The purpose of this function is to prevent malfunctioning of IC at the high junction temperature. Therefore it is not something that urges positive use. It should make sure to operate within the junction temperature range rated ( $\leq +150^{\circ}\text{C}$ ).

\*) Design value

## Application Manual

### ■ The Loss of Constant Current Driver

The power consumption of the LED lighting circuit is classified as "the power consumption of the constant current driver" "the power consumption of the LED" and "the power consumption of the current sense resistor ( $R_S$ )".

The loss of constant current driver is caused mainly by quiescent current ( $I_{DD}$ ) and output current ( $I_{LED}$ ).

The power dissipation of the device can calculate by follow equation.

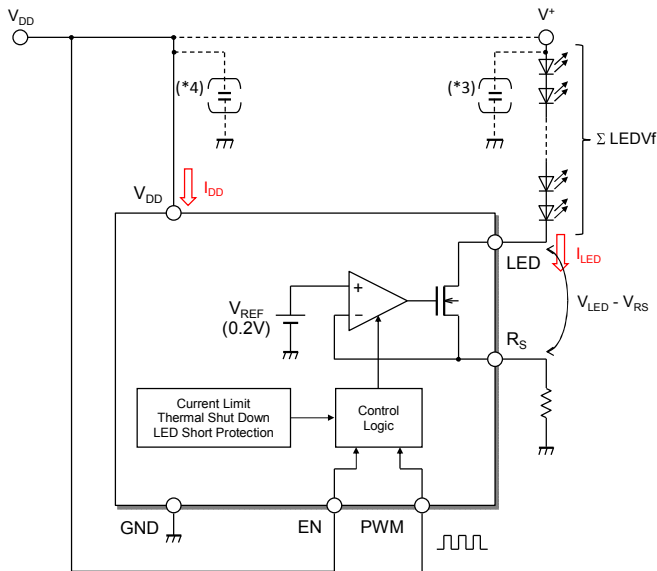

$$P_D \approx V_{DD} \times I_{DD} + (V_{LED} - V_{RS}) \times I_{LED}$$

$$= V_{DD} \times I_{DD} + (V^+ - \Sigma LED Vf - 0.2) \times I_{LED} [W]$$

$R_S$  pin voltage ( $V_{RS}$ ): 0.2V

$\Sigma LED Vf$  represents the sum of the LED Vf of use.

e.g.)

$$V_{DD} = V^+ = 12[V], I_{DD} = 260[\mu A], \Sigma LED Vf = 9[V],$$

$$I_{LED} = 100[mA]$$

$$P_D \approx 12[V] \times 260[\mu A] + (12[V] - 9[V] - 0.2[V]) \times 100[mA]$$

$$\approx 283[mW]$$

As shown in the above equation, the loss of constant current driver will increase in proportion to the voltage difference between the LED driving voltage  $V^+$  and  $\Sigma LED Vf$ .

It should set the LED operating Voltage ( $V^+$ ) and output current ( $I_{LED}$ ) with consideration of  $P_D$ .

**NJW4615AF1 (SOT-23-6)**  
**Power Dissipation**  
 (Topr=-40°C to +125°C, Tj=150°C)

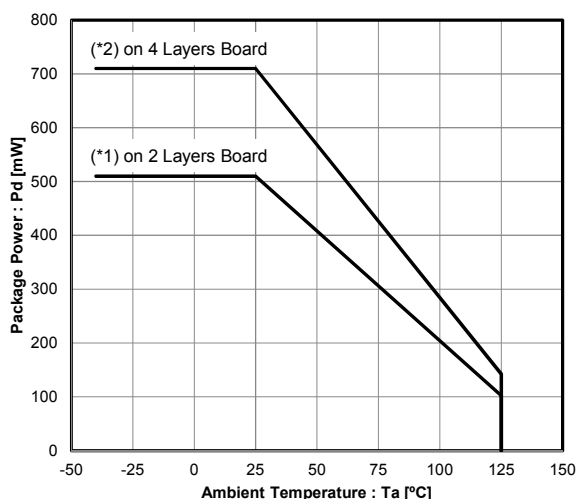

The device power dissipation must be below the power dissipation rate of the device package including thermal derating to ensure correct operation.

(\*1) Mounted on glass epoxy board based on EIA/JEDEC.

(76.2×114.3×1.6mm: 2Layers FR-4)

(\*2) Mounted on glass epoxy board based on EIA/JEDEC.

(76.2×114.3×1.6mm: 4Layers FR-4),

Internal Cu area: 74.2×74.2mm

### ■ Parallel Drive of NJW4615A

For applications that require more than 100mA, it can correspond by parallel connecting two or more NJW4615A. The LED current becomes sum of LED current of each NJW4615A. Each device accepts different set current.

$$I_{LED} [A] = I_{LED1} + I_{LED2} = 0.2 / R_{S1} [\Omega] + 0.2 / R_{S2} [\Omega]$$

(e.g.  $I_{LED} = 150 [mA]$  setting:  $R_{S1} = 4[\Omega]$ ,  $R_{S2} = 2 [\Omega]$  )

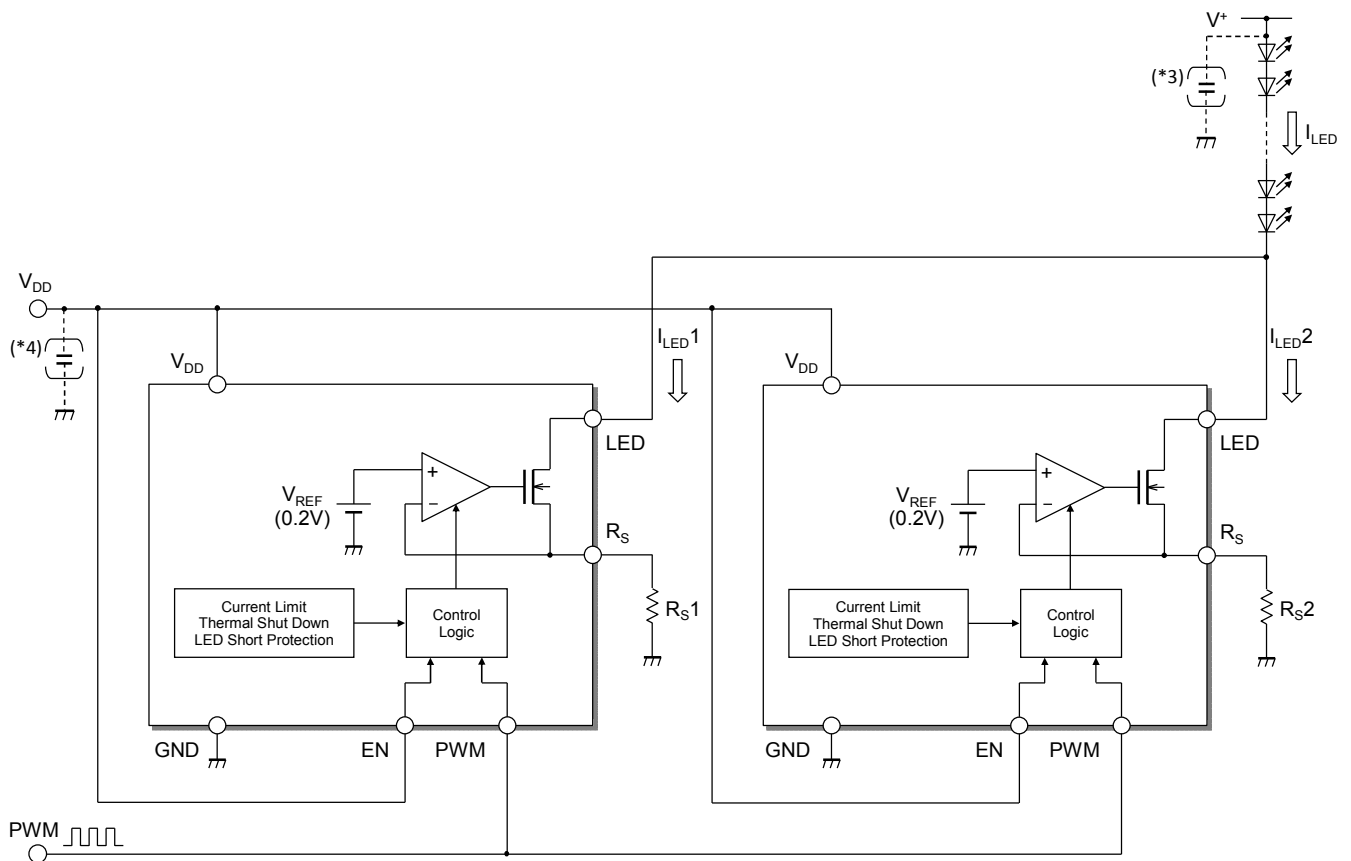

## MEMO

**[CAUTION]**

The specifications on this databook are only given for information, without any guarantee as regards either mistakes or omissions. The application circuits in this databook are described only to show representative usages of the product and not intended for the guarantee or permission of any right including the industrial rights.