

ORCY-D4T12F

Isolated DC-DC Converter

The ORCY-D4T12F is an isolated DC/DC converter that operates from a nominal 48 VDC source. This unit provides up to 240 W of output power from a nominal 48 VDC input. This unit is designed to be highly efficient and low cost.

Features include remote on/off, short circuit protection, over current protection, under voltage lockout and over-temperature protection. The converter is provided in an industry standard 1/8th brick package.

Key Features & Benefits

- 48 VDC Input
- 12 VDC @ 20 A Output
- 1/8th Brick Converter
- Fixed Frequency (350 kHz)
- High Efficiency
- High Power Density
- Input Under Voltage Lockout
- OCP/SCP
- Output Over-voltage Protection
- Over Temperature Protection
- Remote On/Off
- Low Cost
- Basic Isolation
- Approved to IEC/EN 60950-1
- Approved to IEC/EN 62368-1
- Approved to UL/CSA 60950-1
- Approved to UL/CSA 62368-1
- Class II, Category 2, Isolated DC/DC Converter (refer to IPC-9592B)



Applications

- Networking
- Computers and Peripherals
- Telecommunications

1. MODEL SELECTION

MODEL NUMBER	OUTPUT VOLTAGE	INPUT VOLTAGE	MAX. OUTPUT CURRENT	MAX. OUTPUT POWER	TYPICAL EFFICIENCY
ORCY-D4T12FG	12 VDC	48 VDC	20 A	240 W	95.5%

PART NUMBER EXPLANATION

0	R	CY	-	D4	T	12	F	G
Mounting Type	RoHS Status	Series Name		Output Power	Input Range	Output Voltage	Active Logic	Package Type
Through Hole Mount	RoHS	1/8th Brick		240 W	36 - 75 V	12 V	Active Low, with Baseplate	Tray Package

2. ABSOLUTE MAXIMUM RATINGS

PARAMETER	DESCRIPTION	MIN	TYP	MAX	UNITS
Continuous Non-operating Input Voltage		-0.3	-	80	V
Input Transient Voltage	100 ms maximum	-	-	100	V
Remote On/Off		-0.3	-	18	V
I/O Isolation Voltage		-	-	2250	V
Ambient Temperature		-40	-	85	°C
Storage Temperature		-55	-	125	°C
Altitude		-	-	2000	m

NOTE: Ratings used beyond the maximum ratings may cause a reliability degradation of the converter or may permanently damage the device.

3. INPUT SPECIFICATIONS

PARAMETER	DESCRIPTION	MIN	TYP	MAX	UNIT
Operating Input Voltage		36	48	75	V
Input Current (full load)	Test at 40 V input voltage	-	-	8	A
Input Current (no load)		-	60	100	mA
Remote Off Input Current		-	3	6	mA
Input Reflected Ripple Current (rms)	With simulated source impedance of 10 μ H, 5 Hz to 20 MHz. Use a 100 μ F/100 V electrolytic capacitor with ESR = 1 ohm max, at 200 kHz @25°C.	-	2	-	mA
Input Reflected Ripple Current (pk-pk)		-	10	-	mA
I ² t Inrush Current Transient		-	-	2	A ² s
Turn-on Voltage Threshold		-	34	35	V
Turn-off Voltage Threshold		32	33	-	V

CAUTION: This converter is not internally fused. An input line fuse must be used in application. Recommend a fast-acting fuse with maximum rating of 15 A on system board. Refer to the fuse manufacture's datasheet for further information.

NOTE: All specifications are typical at 25°C unless otherwise stated.

4. OUTPUT SPECIFICATIONS

All specifications are typical at nominal input, full load at 25°C unless otherwise stated.

PARAMETER	DESCRIPTION	MIN	TYP	MAX	UNIT
Output Voltage Set Point	Vin = 40 – 75 V	11.76	12.00	12.24	V
Load Regulation	Vin = 40 – 75 V, Io = 0~100% load	-	20	100	mV
Line Regulation	Vin = 36 – 75 V, Io = 100% load	1.8	2.0	2.2	V
	Vin = 40 – 75 V, Io = 100% load	-	20	100	mV
Regulation Over Temperature (-40°C to 85°C)	Vin = 40 – 75 V	-	20	100	mV
Output Ripple and Noise (pk-pk)	Vin = 48 V, Io = 100% load, 0 – 20 MHz BW, with a 1 µF ceramic capacitor, a 10 µF Tantalum cap and a 270 µF AL cap at output.	-	50	100	mV
Output Ripple and Noise (RMS)		-	10	20	mV
Output Ripple and Noise (pk-pk) under worst case	Over entire operating input voltage range, load and ambient temperature condition.	-	-	150	mV
Output Current Range		0	-	20	A
Output DC Current Limit		23	28	33	A
Short Circuit Surge Transient	Iout surge	-	-	1	A ² s
Rise Time		-	10	15	ms
Turn on Time	Ton (Enable form Vin)	-	25	30	ms
	Ton (Enable form ON/OFF)	-	25	30	ms
Overshoot at Turn on		-	0	3	%
Output Capacitance		270	-	6800	µF
TRANSIENT RESPONSE					
ΔV 50% ~ 75% of Max Load		-	300	-	mV
Settling Time	di/dt = 0.1 A/µs, Vin = 48 VDC, with a 1 µF ceramic capacitor, a 10 µF Tantalum cap and a 270 µF AL cap at output.	-	500	-	µs
ΔV 75% ~ 50% of Max Load		-	300	-	mV
Settling Time		-	500	-	µs

5. GENERAL SPECIFICATIONS

PARAMETER	DESCRIPTION	MIN	TYP	MAX	UNIT
Efficiency (Vin = 48 V; Io = Io max)	The efficiency is measured at Vin = 48 V, full load	-	95.5	-	%
Switching Frequency		-	350	-	kHz
Over Temperature Protection		-	125	-	°C
FIT	Calculated Per Bell Core SR-332 (Vin = 48 V, Vo = 12 V, Io = 16 A, Ta = 25 °C, FIT = 10 ⁹ /MTBF)	-	142	-	
Over Voltage Protection (Static)	Hiccup mode	13.5	13.65	13.8	V
Weight		-	39.7	-	g
Dimensions (L x W x H)			2.30 x 0.90 x 0.48		inch
			58.42 x 22.86 x 12.20		mm
ISOLATION CHARACTERISTICS					
Input to Output		-	-	2250	V
Input to Case		-	-	2250	V
Output to Case		-	-	500	V
Isolation Resistance		10M	-	-	Ohm
Isolation Capacitance		-	1000	-	pF

NOTE: All specifications are typical at 25 °C unless otherwise stated.

6. EFFICIENCY DATA

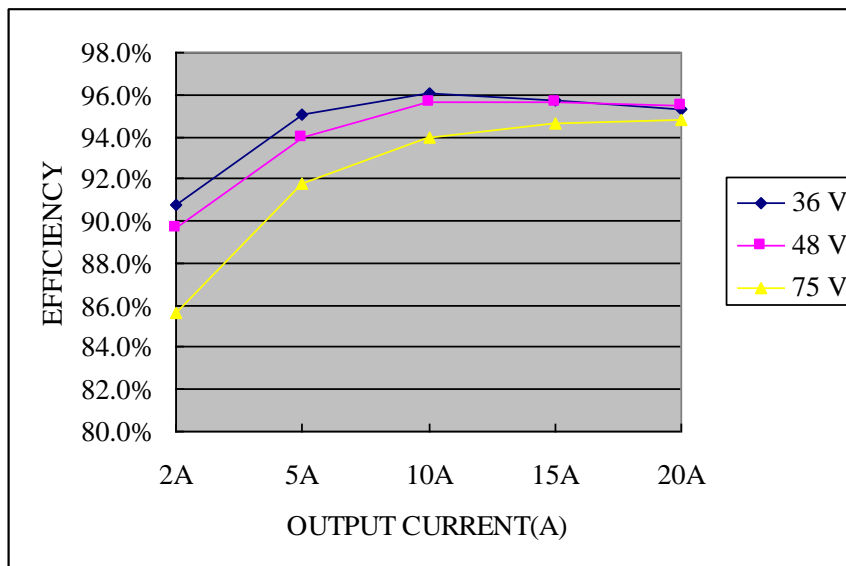

Figure 1. Efficiency data

7. OUTPUT SETPOINT VS. INPUT PLOT

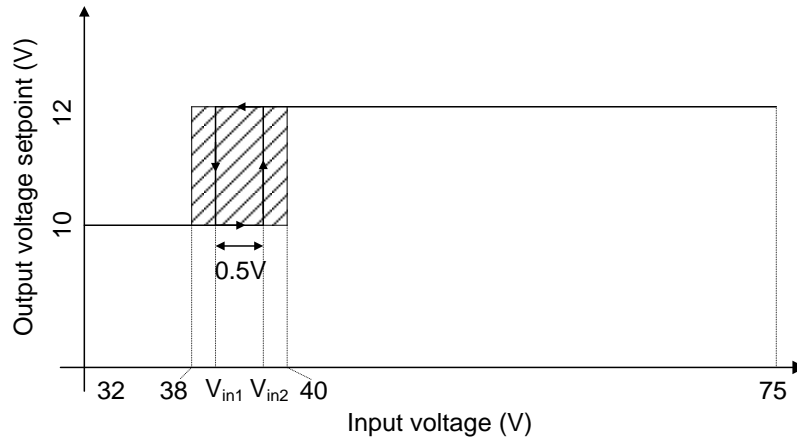

Figure 2. Output setpoint vs input plot

NOTE: 1. Output voltage set point is set to 2 different values according to the input voltage range, and the boundary of the input voltage ranges is within 38 – 40 V.
 2. There is a ~0.5V hysteresis between V_o setpoint-changing thresholds (shown as V_{in1} and V_{in2} above).

8. REMOTE ON/OFF

PARAMETER	DESCRIPTION	MIN	TYP	MAX	UNIT
Signal Low (Unit On)	Active Low	-0.3	-	0.8	V
Signal High (Unit Off)	Remote On/Off pin is open, the module is off.	2.4	-	18	V
Current Sink		0	-	1	mA

Recommended remote on/off circuit for active low

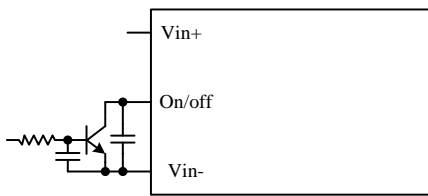

Figure 3. Control with open collector/drain circuit

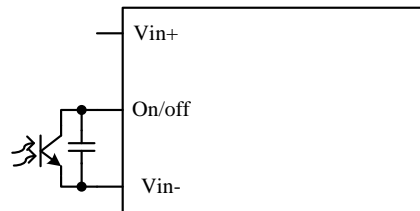

Figure 4. Control with photocoupler circuit

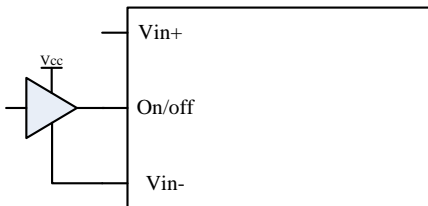

Figure 5. Control with logic circuit

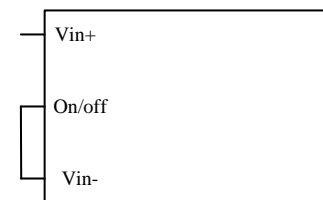

Figure 6. Permanently on

9. RIPPLE AND NOISE WAVEFORM

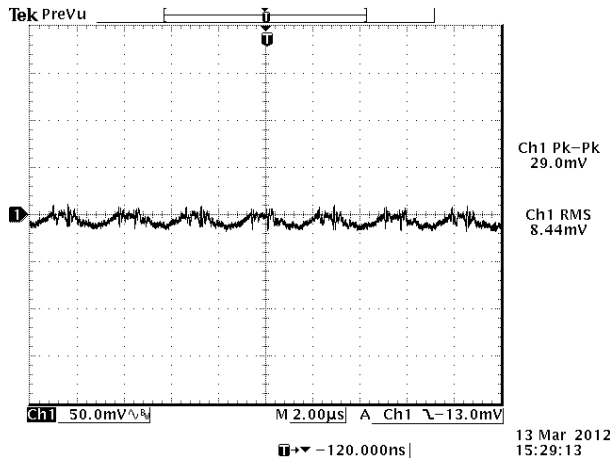

Figure 7. Ripple and noise waveform

NOTE: Ripple and noise at full load, 48 VDC input, 12 VDC / 20 A output and $T_a = 25^\circ\text{C}$, and with a 1 μF ceramic capacitor, a 10 μF Tantalum cap and a 270 μF AL. cap at output.

10. TRANSIENT RESPONSE WAVEFORMS

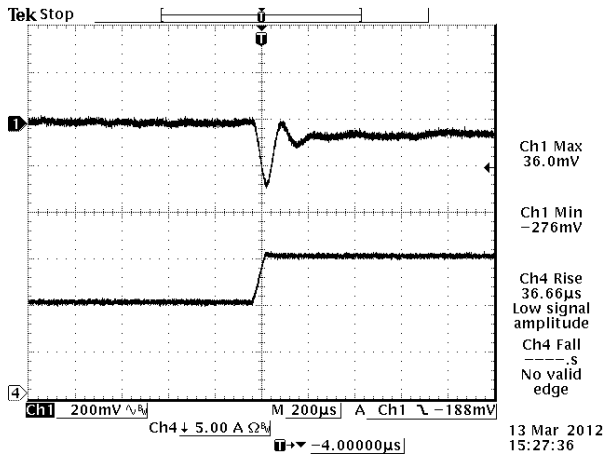

Figure 8. $V_{out} = 12\text{ V}$ 50%-75% Load Transients at $V_{in} = 48\text{ V}$ @ $T_a = 25^\circ\text{C}$

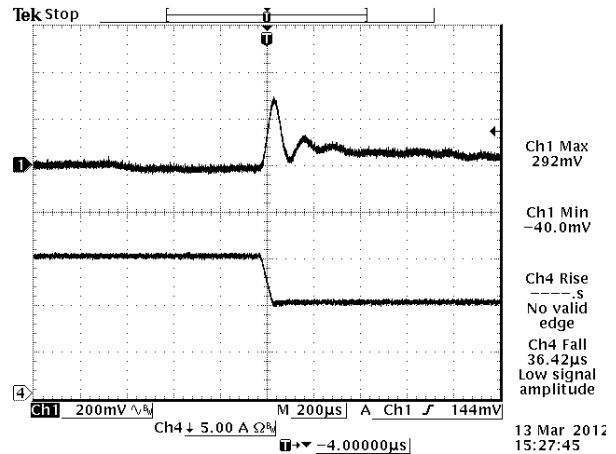

Figure 9. $V_{out} = 12\text{ V}$ 75%-50% Load Transients at $V_{in} = 48\text{ V}$ @ $T_a = 25^\circ\text{C}$

NOTE: Transient Response: $di/dt=0.1\text{ A}/\mu\text{s}$, with a 1 μF ceramic capacitor, a 10 μF Tantalum cap and a 270 μF AL cap at output.

11. STARTUP & SHUTDOWN

RISE TIME

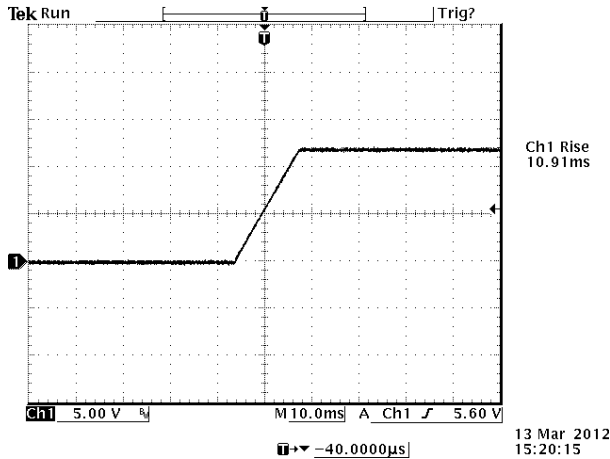

Figure 10. $V_{out} = 12\text{ V} / 20\text{ A}$ at $V_{in} = 48\text{ V}$
 @ $T_a = 25^\circ\text{C}$ $C_{ext} = 270\ \mu\text{F}$

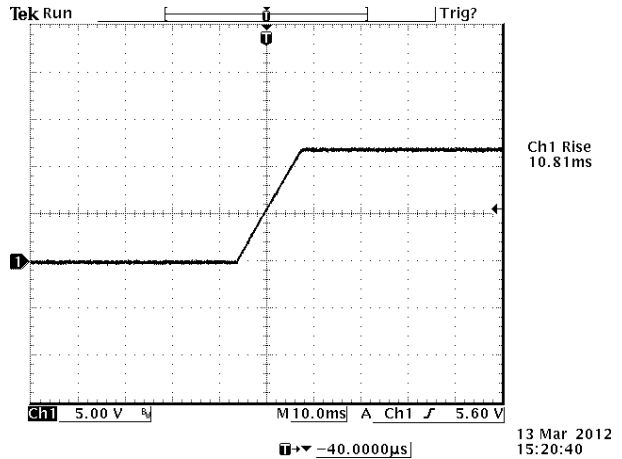

Figure 11. $V_{out} = 12\text{ V} / 20\text{ A}$ at $V_{in} = 48\text{ V}$
 @ $T_a = 25^\circ\text{C}$ $C_{ext} = 6800\ \mu\text{F}$

STARTUP TIME

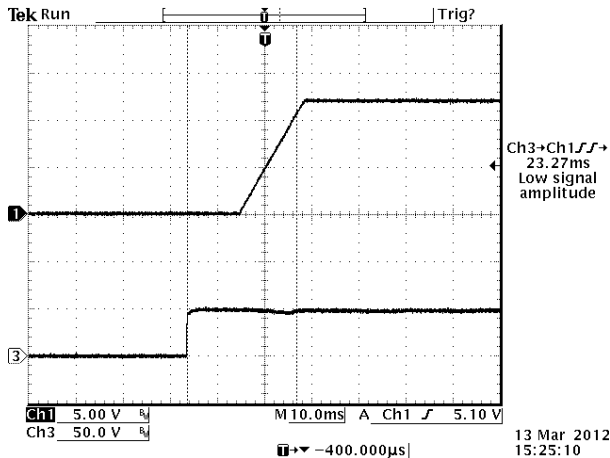

Figure 12. Startup from V_{in}
 Ch1: V_o
 Ch3: V_{in}
 $V_{out} = 12\text{ V} / 20\text{ A}$ at $V_{in} = 48\text{ V}$ @ $T_a = 25^\circ\text{C}$ $C_{ext} = 6800\ \mu\text{F}$

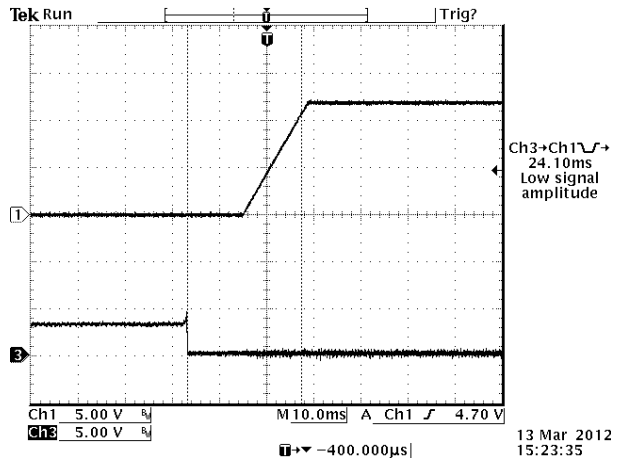

Figure 13. Startup from on/off
 Ch1: V_o
 Ch3: on/off
 $V_{out} = 12\text{ V} / 20\text{ A}$ at $V_{in} = 48\text{ V}$ @ $T_a = 25^\circ\text{C}$ $C_{ext} = 6800\ \mu\text{F}$

SHUTDOWN

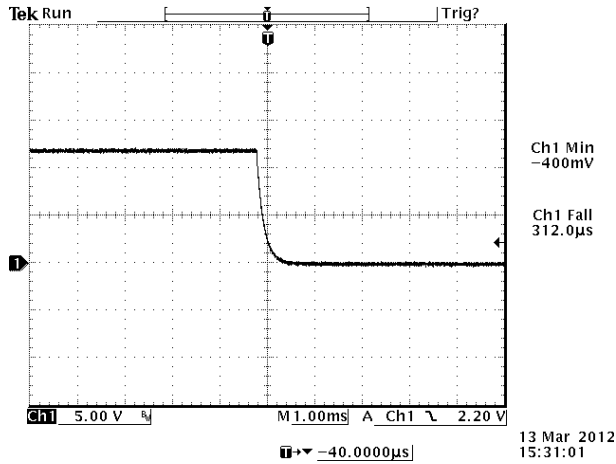

Figure 14. $V_{out} = 12\text{ V} / 20\text{ A}$ at $V_{in} = 48\text{ V}$
 @ $T_a = 25^\circ\text{C}$ $C_{ext} = 270\ \mu\text{F}$

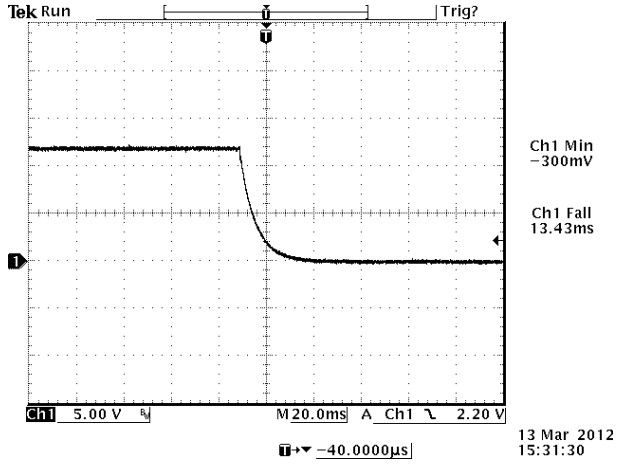

Figure 15. $V_{out} = 12\text{ V} / 20\text{ A}$ at $V_{in} = 48\text{ V}$
 @ $T_a = 25^\circ\text{C}$ $C_{ext} = 6800\ \mu\text{F}$

12. OVER CURRENT PROTECTION

To provide protection in a fault output overload condition, the module is equipped with internal over current protection circuitry. If the over current condition occurs, the module will shut down into hiccup mode and restart once every 400 ms. The module operates normally when the output current goes into specified range.

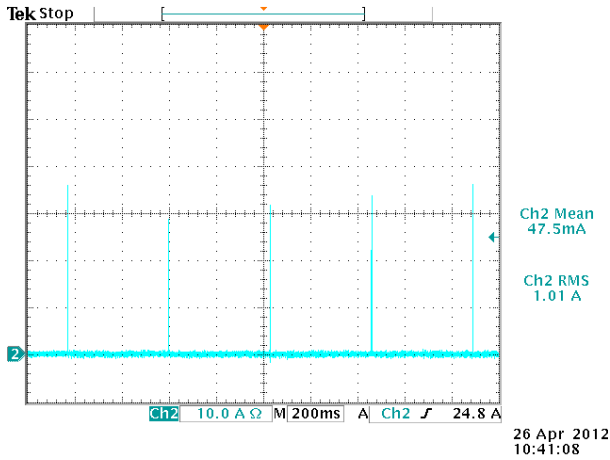

Figure 16. $V_{in} = 48\text{ V}$ @ $T_a = 25^\circ\text{C}$

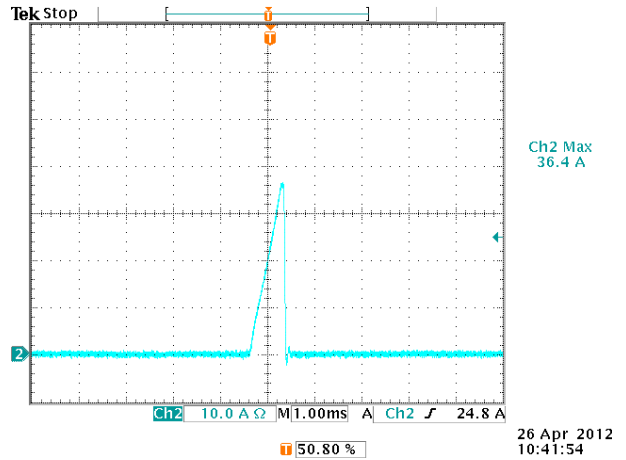

Figure 17. Expansion of on time portion of above figure
 CH2: Output current waveform

13. INPUT UNDER-VOLTAGE LOCKOUT

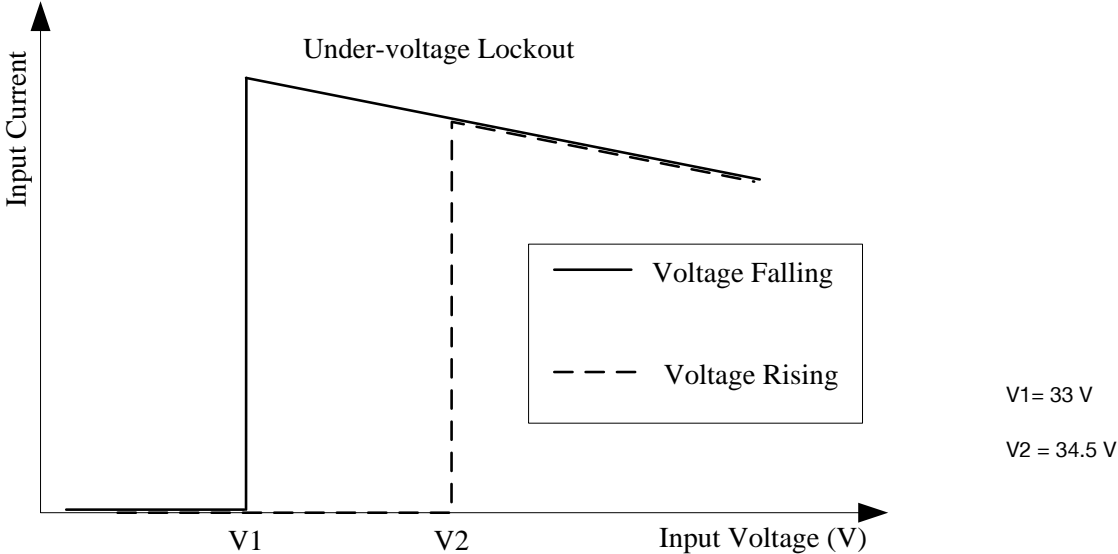

Figure 18. Input under-voltage lockout

14. THERMAL DERATING CURVE

Maximum FET junction temperature derated to 120 °C

The OTP is achieved by temperature sensor U10 and it's in non-latch mode when the hottest component U7 reaches 115 °C with 200 LFM air flow correspondingly. It will restart automatically when the temperature falls to 105 °C. The protecting point will be varied a little under different conditions (air flow, ambient temperature, input voltage, load...).

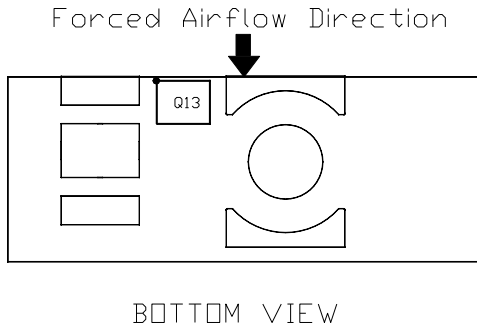

Figure 19. Forced airflow direction

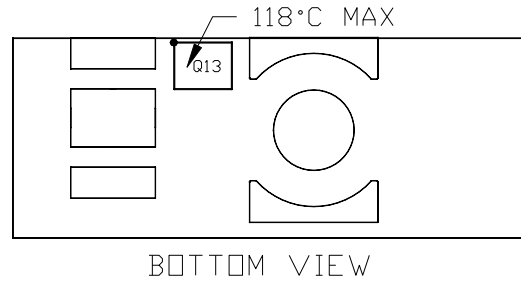

Figure 20. Temperature reference points on bottom side

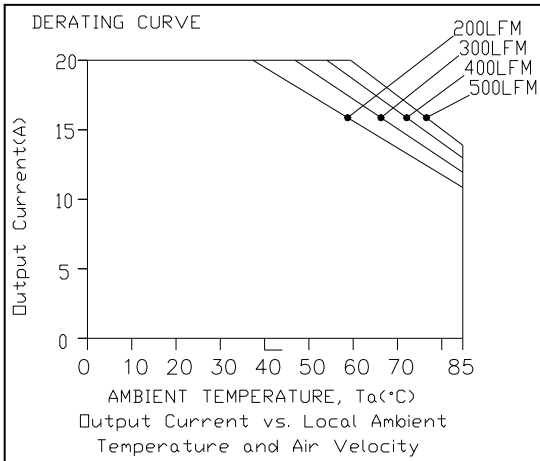

Figure 21. Vin = 48 V without heat spreader

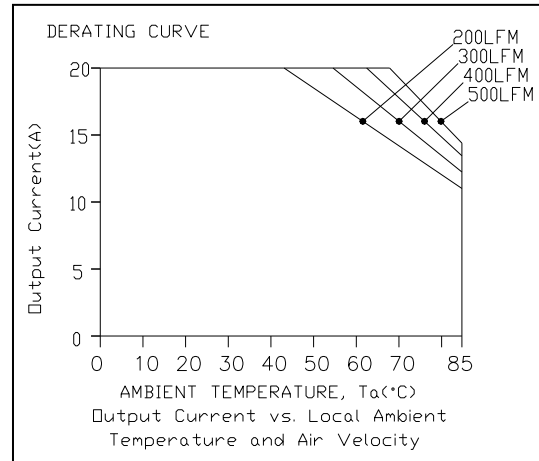

Figure 22. Vin = 48 V with heat spreader

15. SAFETY & EMC

SAFETY:

- Material flammability: UL94V-0
- Compliance to IEC/EN 60950-1
- Compliance to IEC/EN 62368-1
- Compliance to UL/CSA 60950-1
- Compliance to UL/CSA 62368-1

EMC:

Compliance to EN 55032 class A (both peak and average) with the following inductive and capacitive filter.

Test setup:

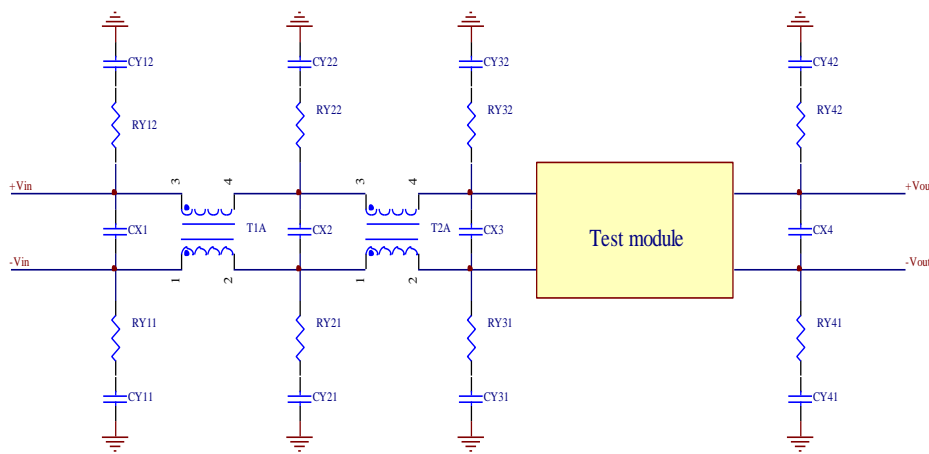

Figure 23. Test setup

ITEM	DESIGNATOR	PARAMETER	VENDOR	VENDOR P/N
1	CX2	100uF/100V, AL cap		
2	CX3	220uF/100V, AL cap		
3	CY31	2*6.8nF/1000V,ceramic		
4	CY32	2*6.8nF/1000V,ceramic		
5	CY41	6.8nF/1000V,ceramic		
6	CY42	6.8nF/1000V,ceramic		
7	RY31	1206,0R,Resistor		
8	RY32	1206,0R,Resistor		
9	RY41	1206,0R,Resistor		
10	RY42	1206,0R,Resistor		
11	T2A	0.81mH, common mode		
12	T1A,CX1,CX2 RY11,RY21,RY12 RY22,CY11,CY21	NIL		

CY12,CY22

POSITIVE:

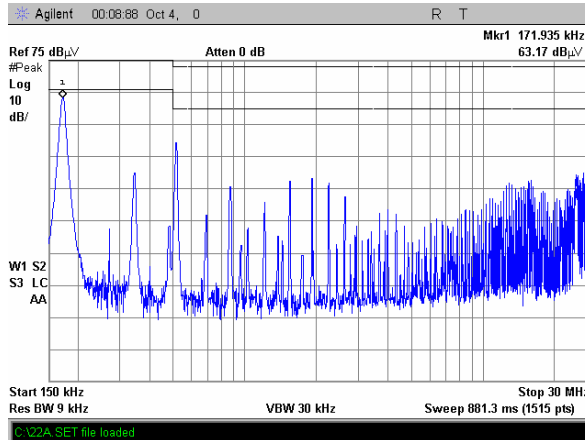

Figure 24. Positive

NEGATIVE:

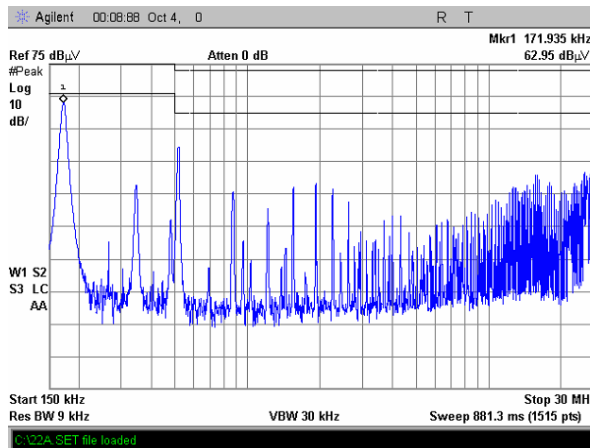

Figure 25. Negative

16. MECHANICAL DIMENSIONS

OUTLINE

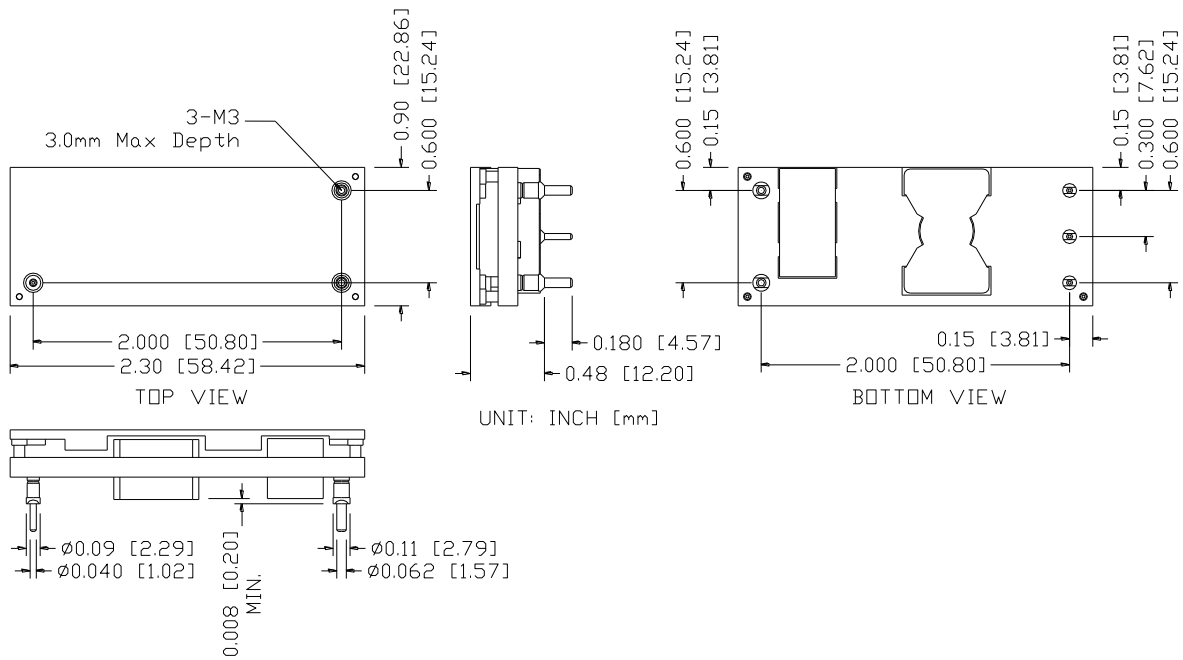

Figure 26. Outline

NOTE: This module is recommended and compatible with Pb-Free Wave Soldering and must be soldered using a peak solder temperature of no more than 260 °C for less than 5 seconds.

NOTES:

- 1) All Pins: Material - Copper Alloy;
Finish – 3 micro inches minimum Gold over 50 micro inches minimum Nickel plate.
- 2) Un-dimensioned components are shown for visual reference only.
- 3) All dimensions in inch [mm]; Tolerances: x.xx +/-0.02 inch [0.51 mm]. x.xxx +/-0.010 inch [0.25 mm].

PIN DEFINITIONS

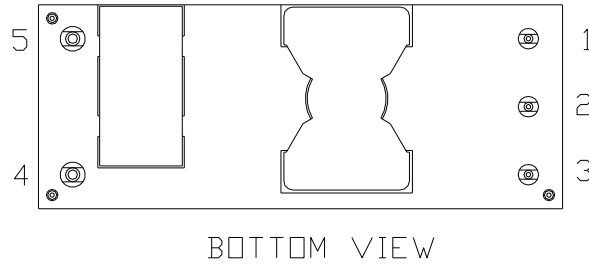

Figure 27. Pins

PIN	NAME	PIN DIA
1	Vin (+)	0.04"
2	Enable	0.04"
3	Vin (-)	0.04"
4	Vout(-)	0.06"
5	Vout+	0.06"

RECOMMENDED PAD LAYOUT

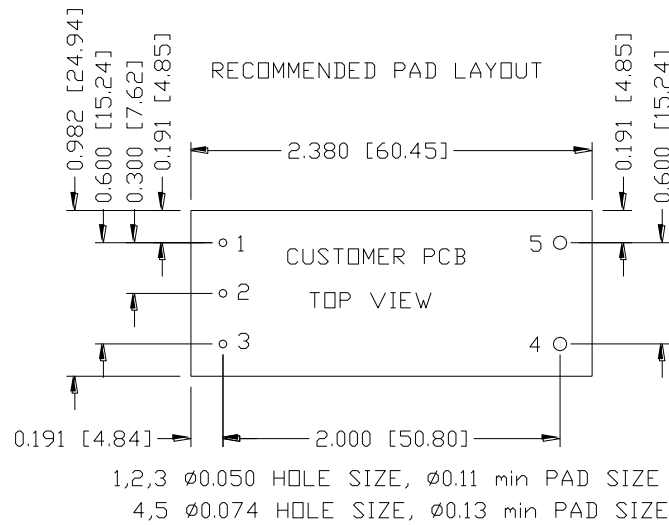

Figure 28. Recommended pad layout

17. REVISION HISTORY

DATE	REVISION	CHANGES DETAIL	APPROVAL
2013-11-14	PA	First release	Z.Tang
2014-10-08	PB	Change Isolation characteristics, I/O Isolation Voltage	Z.Tang
2016-12-20	AC	First release	XF.Jiang
2017-05-09	AD	Add Over Voltage Protection (Static)	XF.Jiang
2020-08-13	AF	Change the title by adding suffix of E,F	XF.Jiang
2020-10-14	AG	Delete ORCY-D4T12E. Update safety information.	XF.Jiang
2021-05-05	AH	Add object ID. Update mechanical outline.	XF.Jiang

For more information on these products consult: tech.support@psbel.com

NUCLEAR AND MEDICAL APPLICATIONS - Products are not designed or intended for use as critical components in life support systems, equipment used in hazardous environments, or nuclear control systems.

TECHNICAL REVISIONS - The appearance of products, including safety agency certifications pictured on labels, may change depending on the date manufactured. Specifications are subject to change without notice.



Asia-Pacific
+86 755 298 85888

Europe, Middle East
+353 61 225 977

North America
+1 408 785 5200