

CMS16N06D-HF

**N-Channel
RoHS Device
Halogen Free**

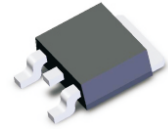

Features

- Low reverse transfer capacitance.
- High switching speed.
- Improved dv/dt capability.
- 100% EAS guaranteed.
- Green device available.

Mechanical data

- Case: D-PAK/TO-252 standard package, molded plastic.

Description

The CMS16N06D is the highest performance N-ch MOSFETs with super high dense cell density for extremely low RDS(ON) and gate charge for most of the synchronous buck converter applications. The CMS16N06D meet the ROHS and Green Product require ment, 100% EAS guaranteed with full function reliability approved.

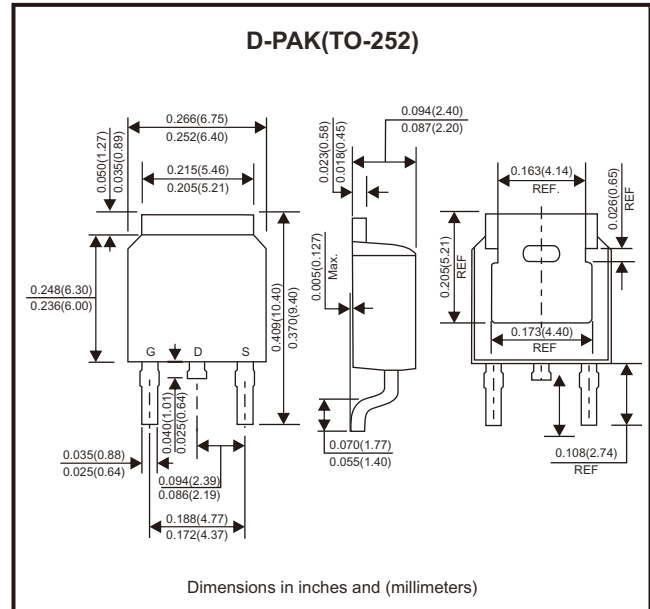

Circuit Diagram

- G : Gate
- D : Drain
- S : Source

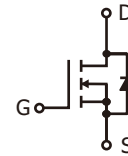

Maximum Ratings (at TA=25°C unless otherwise noted)

Parameter	Conditions	Symbol	Value	Unit
Drain-source voltage		V _{DS}	60	V
Gate-source voltage		V _{GS}	±20	V
Continuous drain current (Note 1)	T _C = 25°C	I _D	16	A
	T _C = 100°C	I _D	10	
Pulsed drain current (Note 1, 2)	T _C = 25°C	I _{DM}	64	A
Continuous drain current	T _A = 25°C	I _D	4.4	A
	T _A = 70°C	I _D	3.5	
Total power dissipation (Note 4)	T _C = 25°C	P _D	27	W
	T _A = 25°C	P _D	2	
Single pulse avalanche energy, L=0.1mH (Note 3)		E _{AS}	11	mJ
Single pulse avalanche current, L=0.1mH (Note 3)		I _{AS}	15	A
Operating junction and storage temperature range		T _J , T _{STG}	-55 to +150	°C

Thermal Data

Parameter	Conditions	Symbol	Max. Value	Unit
Thermal resistance junction-ambient (Note 1)	Steady state	R _{θJA}	62.5	°C/W
Thermal resistance junction-case (Note 1)	Steady state	R _{θJC}	4.6	°C/W

Electrical Characteristics (at T_J=25°C unless otherwise noted)

Parameter	Symbol	Min	Typ	Max	Unit	Conditions
Drain-source breakdown voltage	BV _{DSS}	60			V	V _{GS} = 0, I _D = 250μA
Gate threshold voltage	V _{GS(th)}	1.0	1.8	2.5	V	V _{DS} = V _{GS} , I _D = 250μA
Gate-source leakage current	I _{GSS}			±100	nA	V _{GS} = ±20V
Drain-source leakage current	I _{DSS}			1	μA	V _{DS} = 60V, V _{GS} = 0
Static drain-source on-resistance (Note 2)	R _{DS(on)}		37	50	mΩ	V _{GS} = 10V, I _D = 8A
			42	60		V _{GS} = 4.5V, I _D = 4A
Total gate charge (Note 2)	Q _g		14		nC	I _D = 4A, V _{DS} = 30V, V _{GS} = 10V
Gate-source charge	Q _{gs}		2.9			
Gate-drain ("Miller") charge	Q _{gd}		2.3			
Turn-on delay time (Note 2)	t _{d(on)}		3.9		ns	V _{DS} = 30V, I _D = 1A, V _{GS} = 10V, R _G = 3.3Ω
Rise time	t _r		13			
Turn-off delay time	t _{d(off)}		23			
Fall time	t _f		6.7			
Input capacitance	C _{iss}		815		pF	V _{GS} = 0V, V _{DS} = 15V, f = 1MHz
Output capacitance	C _{oss}		379			
Reverse transfer capacitance	C _{rss}		110			
Guaranteed avalanche characteristics						
Single pulse avalanche energy (Note 5)	EAS	3.2			mJ	V _{DD} = 25V, L = 0.1mH, I _{AS} = 8A
Source-drain diode						
Diode forward voltage (Note 2)	V _{SD}		0.73	1.0	V	I _S = 1A, V _{GS} = 0V, T _J = 25°C
Continuous source current (Note 1, 6)	I _S			16	A	

- Notes: 1. The data tested by surface mounted on a 1 inch² FR-4 board with 2OZ copper.
 2. The data tested by pulsed, pulse width ≤ 300μs, duty cycle ≤ 2%.
 3. The EAS data shows Max. rating. The test condition is V_{DD}=25V, V_{GS}=10V, L=0.1mH, I_{AS}=15A.
 4. The power dissipation is limited by 150°C junction temperature.
 5. The min. value is 100% EAS tested guarantee.
 6. The data is theoretically the same as I_D and I_{DM}, in real applications, should be limited by total power dissipation.

Rating and Characteristic Curves (CMS16N06D-HF)

Typical Characteristics

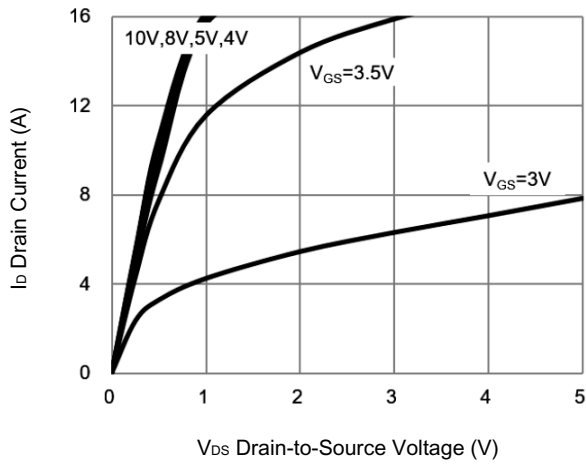

Fig.1 Typical Output Characteristics

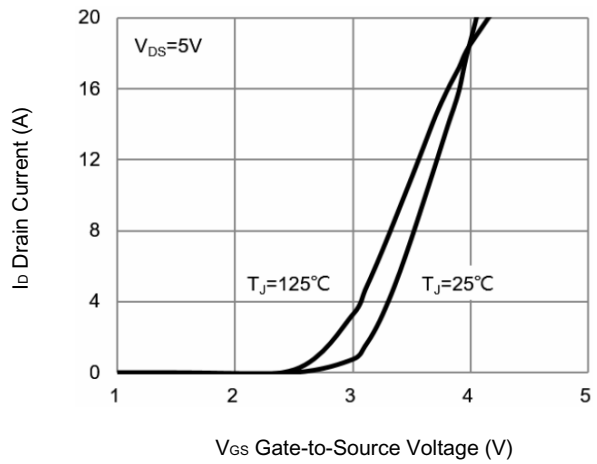

Fig.2 Transfer Characteristics

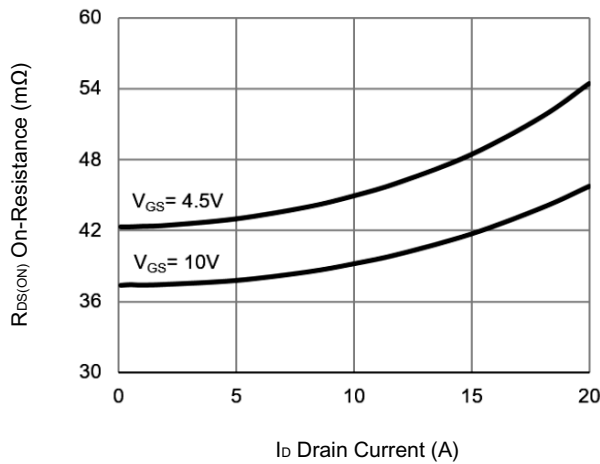

Fig.3 On-Resistance vs. Drain Current

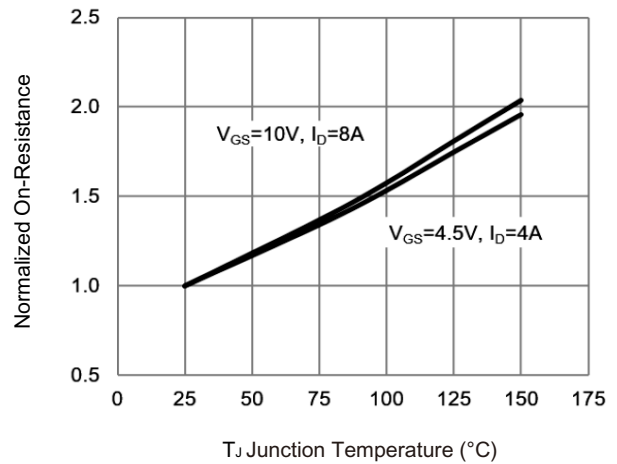

Fig.4 Normalized $R_{DS(on)}$ vs. T_J

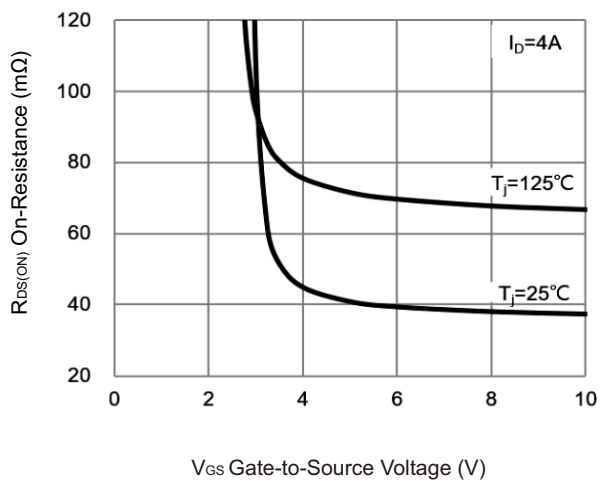

Fig.5 On-Resistance vs. G-S Voltage

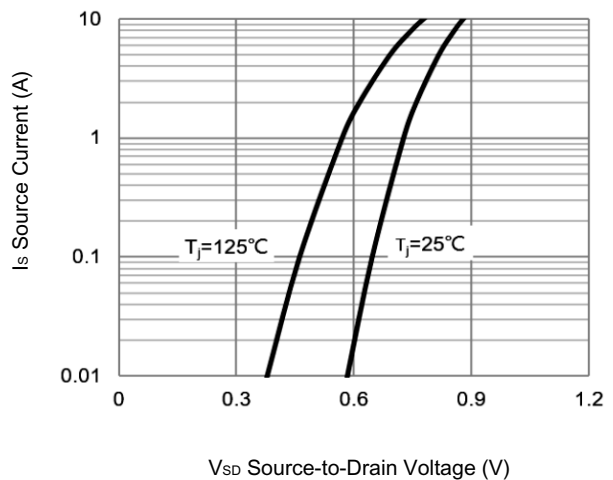

Fig.6 Forward Characteristics of Reverse

Company reserves the right to improve product design, functions and reliability without notice.

REV:B

Rating and Characteristic Curves (CMS16N06D-HF)

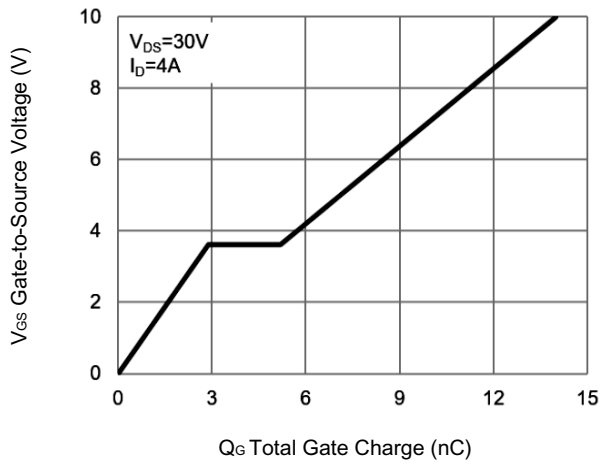

Fig.7 Gate Charge Characteristics

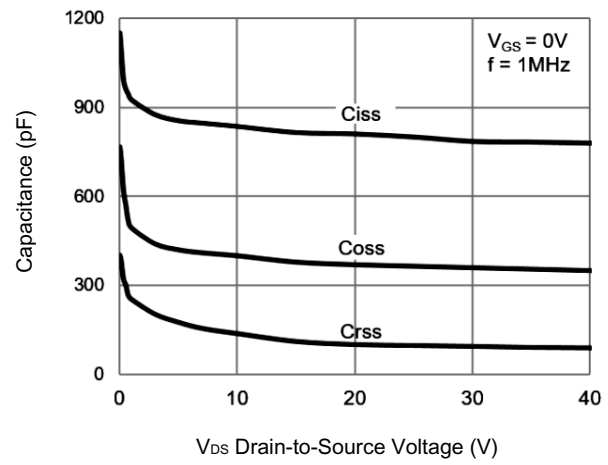

Fig.8 Capacitance Characteristics

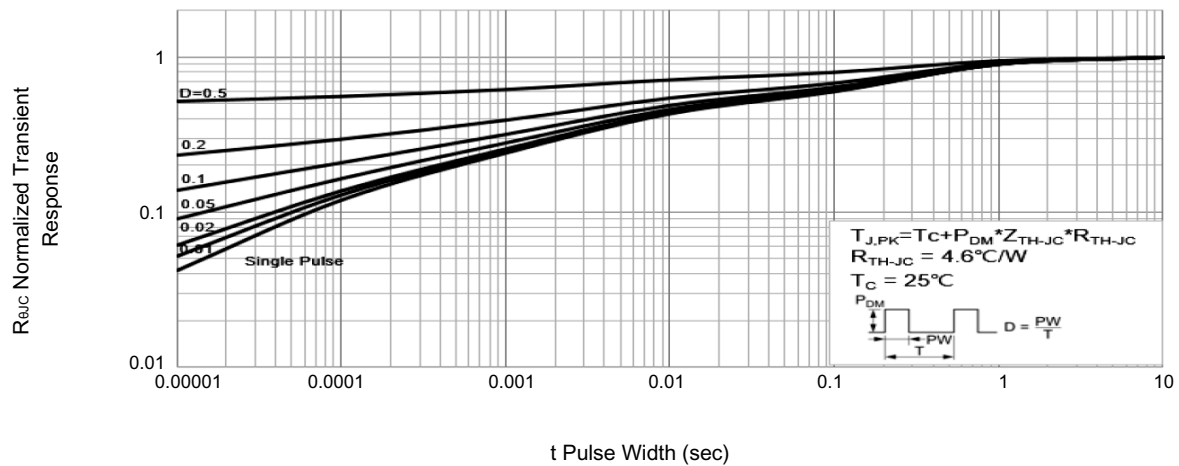

Fig.9 Normalized Maximum Transient Thermal Impedance

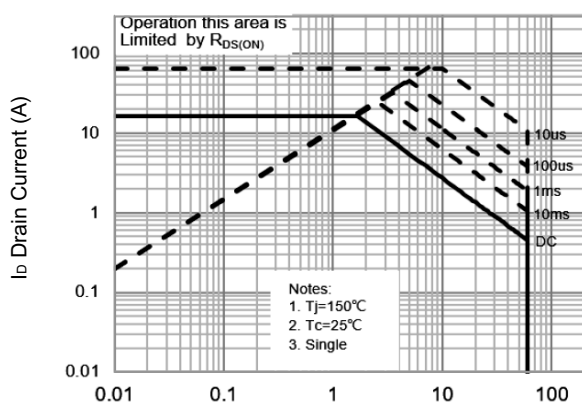

Fig.10 Safe Operating Area

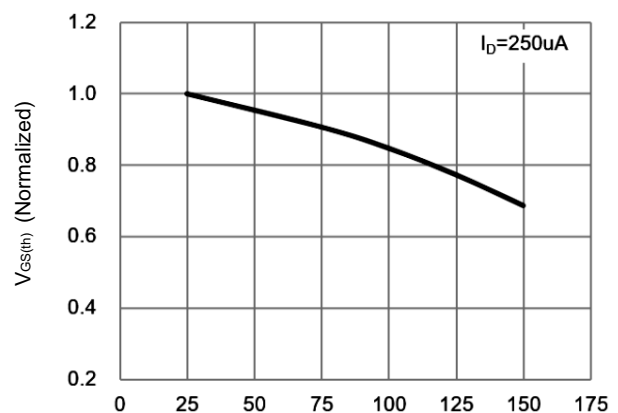
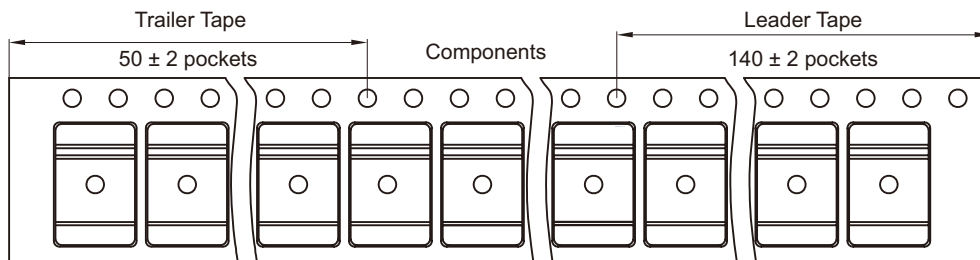
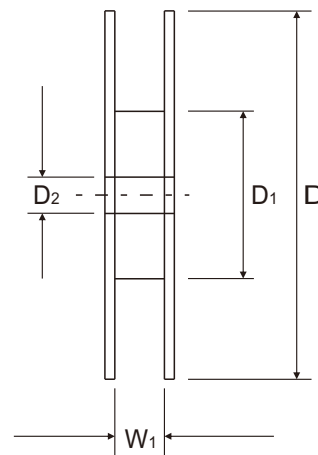
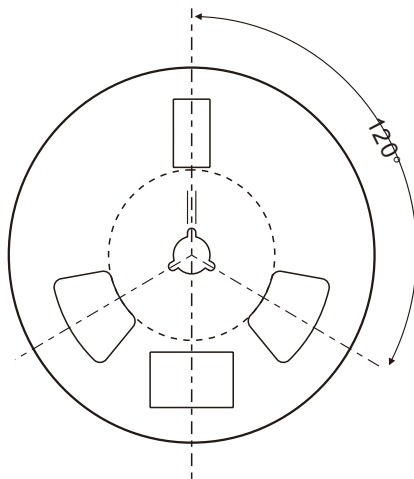
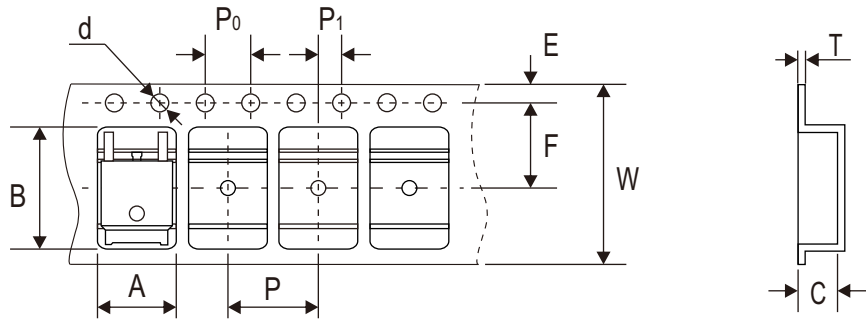

Fig.11 Normalized $V_{GS(th)}$ vs. Temperature

Reel Taping Specification



TO-252 (D-PAK)	SYMBOL	A	B	C	d	D	D1	D2
	(mm)	6.90 ± 0.10	10.50 ± 0.10	2.78 ± 0.10	1.50 ± 0.10	330 ± 1.00	100.00 ± 0.50	13.20 ± 0.20
	(inch)	0.272 ± 0.004	0.413 ± 0.004	0.109 ± 0.004	0.059 ± 0.004	12.992 ± 0.039	3.937 ± 0.020	0.520 ± 0.008

TO-252 (D-PAK)	SYMBOL	E	F	P	P0	P1	T	W	W1
	(mm)	1.75 ± 0.10	7.50 ± 0.10	8.00 ± 0.10	4.00 ± 0.10	2.00 ± 0.10	0.25 ± 0.02	16.00 ± 0.10	16.40 ± 0.02
	(inch)	0.069 ± 0.004	0.295 ± 0.004	0.315 ± 0.004	0.157 ± 0.004	0.079 ± 0.004	0.010 ± 0.001	0.630 ± 0.004	0.646 ± 0.01

Company reserves the right to improve product design , functions and reliability without notice. REV:B

Marking Code

Part Number	Marking Code
CMS16N06D-HF	16N06A

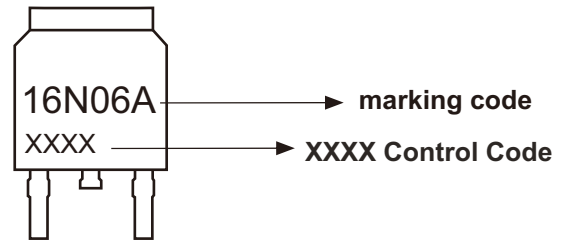

Suggested P.C.B. PAD Layout

SIZE	TO-252 / DPAK	
	(mm)	(inch)
A	4.60	0.181
B	1.40	0.055
C	6.00	0.236
D	6.50	0.256
E	3.00	0.118
F	6.25	0.246

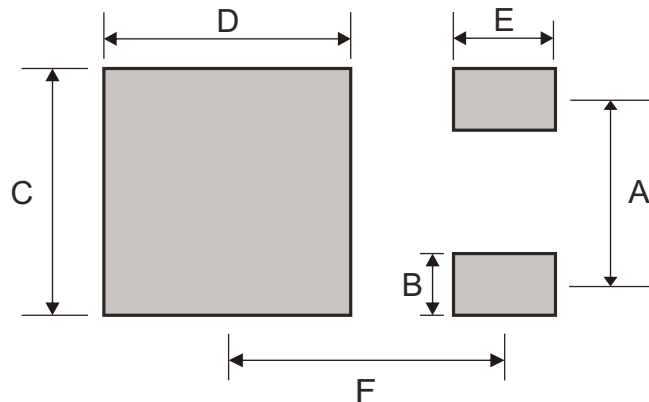

Note: 1. The pad layout is for reference purposes only.

Standard Packaging

Case Type	REEL PACK	
	REEL (pcs)	REEL SIZE (inch)
TO-252/D-PAK	2,500	13