

## N-Channel Enhancement Mode Power MOSFET

### Description

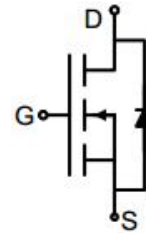
The G70N04T uses advanced trench technology to provide excellent  $R_{DS(ON)}$ , low gate charge. It can be used in a wide variety of applications.

### General Features

- $V_{DS}$  40V
- $I_D$  (at  $V_{GS} = 10V$ ) 70A
- $R_{DS(ON)}$  (at  $V_{GS} = 10V$ ) < 7m $\Omega$
- $R_{DS(ON)}$  (at  $V_{GS} = 4.5V$ ) < 9m $\Omega$
- 100% Avalanche Tested
- RoHS Compliant

### Application

- Power switch
- DC/DC converters



Schematic diagram



TO-220

### Ordering Information

Device	Package	Marking	Packaging
G70N04T	TO-220	G70N04	50psc/Tube

### Absolute Maximum Ratings $T_C = 25^\circ\text{C}$ , unless otherwise noted

Parameter	Symbol	Value	Unit
Drain-Source Voltage	$V_{DS}$	40	V
Continuous Drain Current	$I_D$	70	A
Pulsed Drain Current (note1)	$I_{DM}$	280	A
Gate-Source Voltage	$V_{GS}$	$\pm 20$	V
Power Dissipation	$P_D$	104	W
Single pulse avalanche energy (note2)	$E_{AS}$	56	mJ
Operating Junction and Storage Temperature Range	$T_J, T_{stg}$	-55 To 150	$^\circ\text{C}$

### Thermal Resistance

Parameter	Symbol	Value	Unit
Thermal Resistance, Junction-to-Ambient	$R_{thJA}$	15	$^\circ\text{C/W}$
Maximum Junction-to-Case	$R_{thJC}$	1.2	$^\circ\text{C/W}$

Specifications $T_J = 25^\circ\text{C}$ , unless otherwise noted						
Parameter	Symbol	Test Conditions	Value			Unit
			Min.	Typ.	Max.	
<b>Static Parameters</b>						
Drain-Source Breakdown Voltage	$V_{(BR)DSS}$	$V_{GS} = 0V, I_D = 250\mu A$	40	--	--	V
Zero Gate Voltage Drain Current	$I_{DSS}$	$V_{DS} = 40V, V_{GS} = 0V$	--	--	1	$\mu A$
Gate-Source Leakage	$I_{GSS}$	$V_{GS} = \pm 20V$	--	--	$\pm 100$	nA
Gate-Source Threshold Voltage	$V_{GS(th)}$	$V_{DS} = V_{GS}, I_D = 250\mu A$	1.1	1.7	2.4	V
Drain-Source On-Resistance	$R_{DS(on)}$	$V_{GS} = 10V, I_D = 30A$	--	6	7	m $\Omega$
		$V_{GS} = 4.5V, I_D = 20A$	--	7.5	9	
Forward Transconductance	$g_{FS}$	$V_{GS} = 5V, I_D = 30A$	--	89	--	S
<b>Dynamic Parameters</b>						
Input Capacitance	$C_{iss}$	$V_{GS} = 0V,$ $V_{DS} = 20V,$ $f = 1.0\text{MHz}$	--	2169	--	pF
Output Capacitance	$C_{oss}$		--	179	--	
Reverse Transfer Capacitance	$C_{rss}$		--	159	--	
Total Gate Charge	$Q_g$	$V_{DD} = 20V,$ $I_D = 30A,$ $V_{GS} = 10V$	--	50	--	nC
Gate-Source Charge	$Q_{gs}$		--	12	--	
Gate-Drain Charge	$Q_{gd}$		--	13	--	
Turn-on Delay Time	$t_{d(on)}$	$V_{DD} = 20V,$ $I_D = 30A,$ $R_G = 3\Omega$	--	11	--	ns
Turn-on Rise Time	$t_r$		--	10	--	
Turn-off Delay Time	$t_{d(off)}$		--	38	--	
Turn-off Fall Time	$t_f$		--	11	--	
<b>Drain-Source Body Diode Characteristics</b>						
Continuous Body Diode Current	$I_S$	$T_C = 25^\circ\text{C}$	--	--	70	A
Body Diode Voltage	$V_{SD}$	$T_J = 25^\circ\text{C}, I_{SD} = 30A, V_{GS} = 0V$	--	--	1.2	V

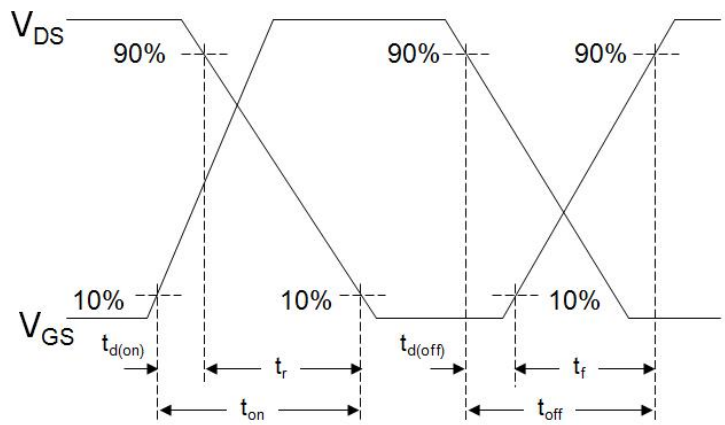
### Notes

1. Repetitive Rating: Pulse width limited by maximum junction temperature
2. EAS condition :  $T_J = 25^\circ\text{C}, V_{DD} = 40V, V_{GS} = 10V, L = 0.5\text{mH}, R_G = 25\Omega$
3. Identical low side and high side switch with identical  $R_G$

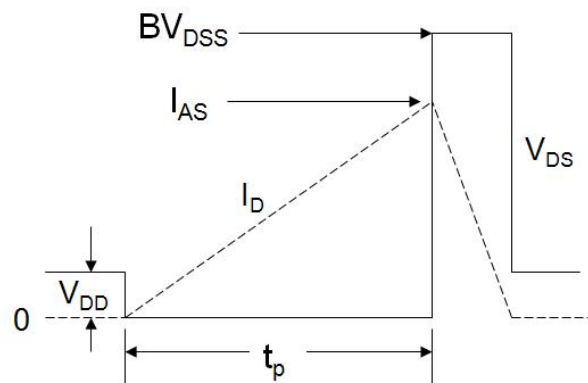
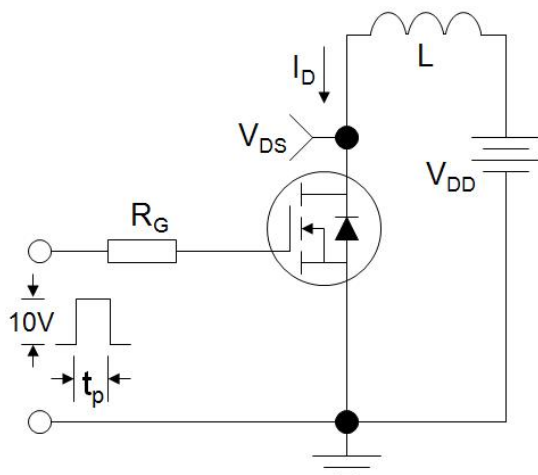
### Gate Charge Test Circuit



### Switch Time Test Circuit

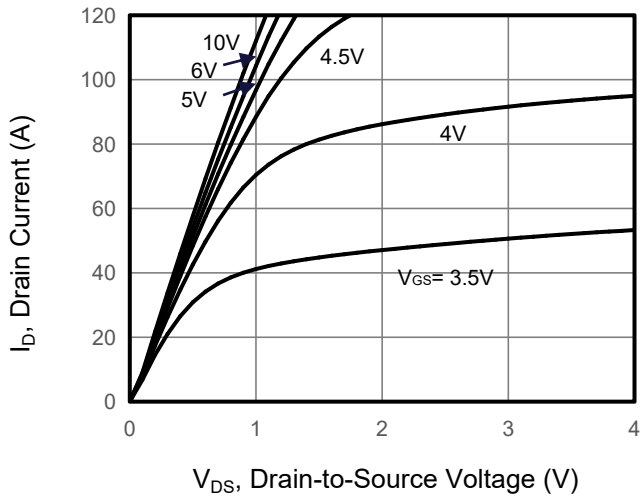


### EAS Test Circuit

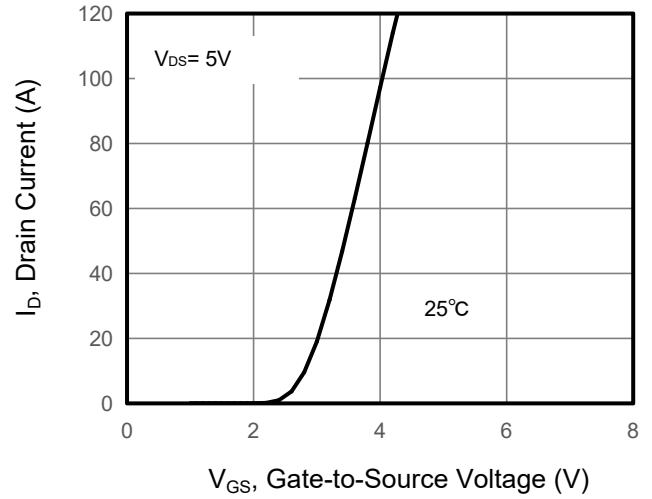


Typical Characteristics  $T_J = 25^\circ\text{C}$ , unless otherwise noted

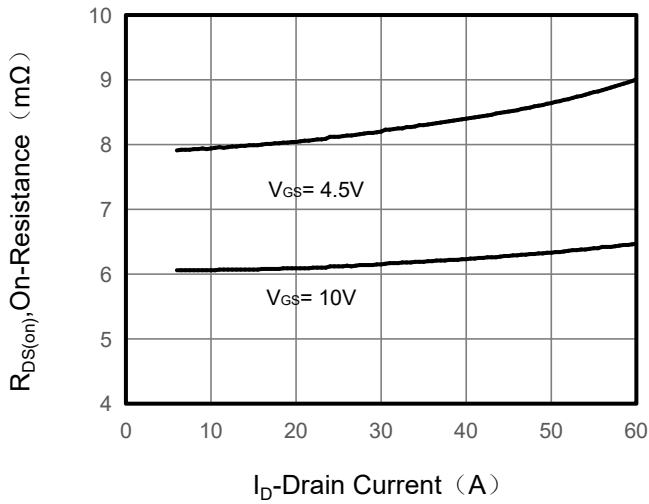
**Figure 1. Output Characteristics**



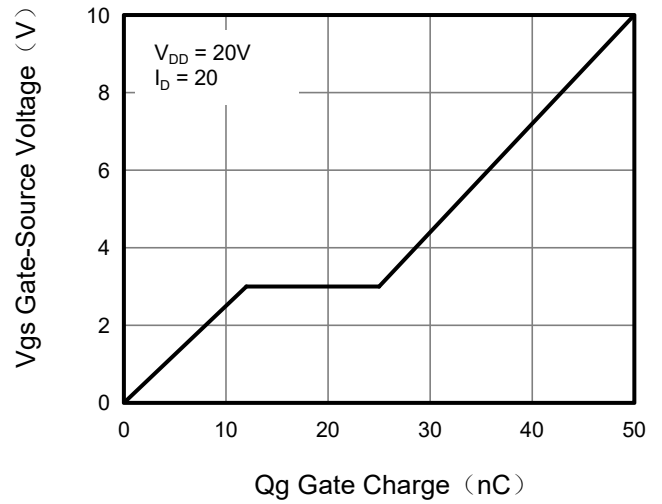
**Figure 2. Transfer Characteristics**



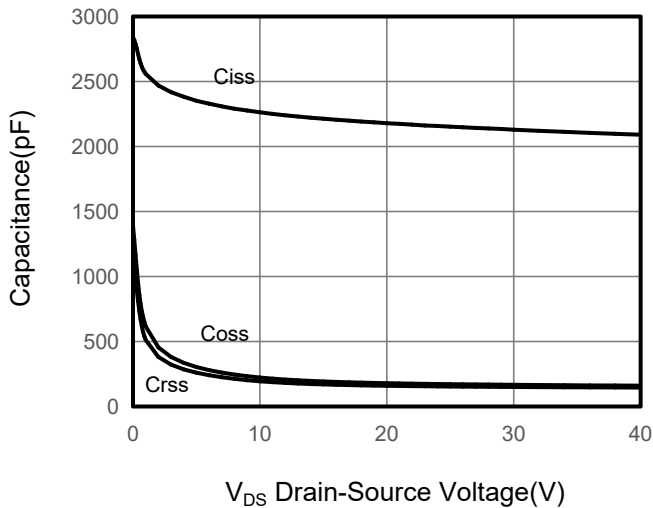
**Figure 3. Drain Source On Resistance**



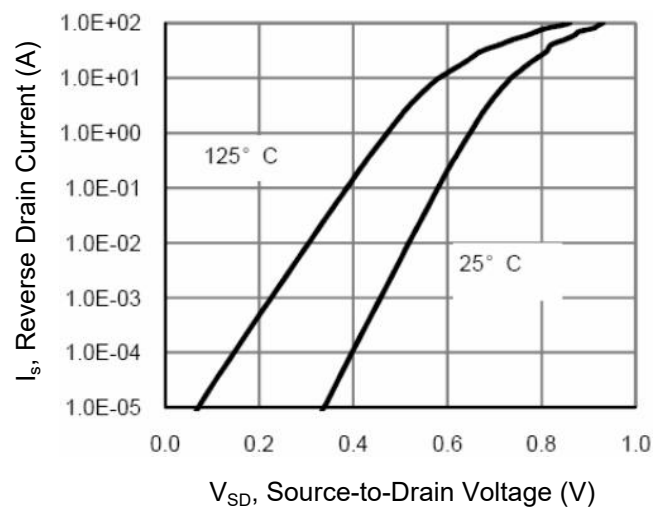
**Figure 4. Gate Charge**



**Figure 5. Capacitance**

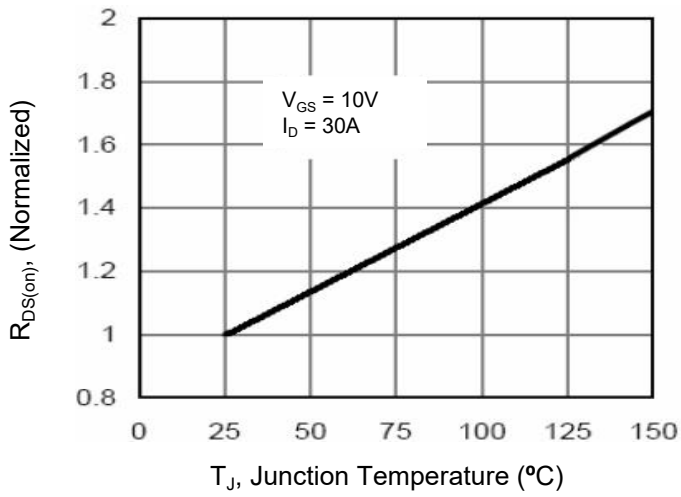


**Figure 6. Source-Drain Diode Forward**

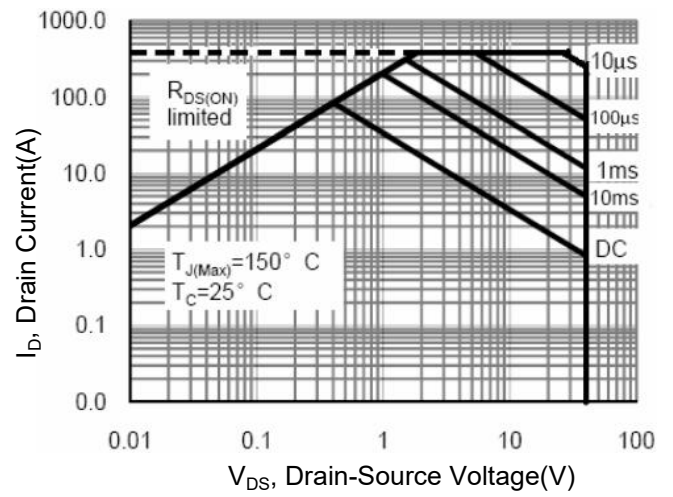


## Typical Characteristics $T_J = 25^\circ\text{C}$ , unless otherwise noted

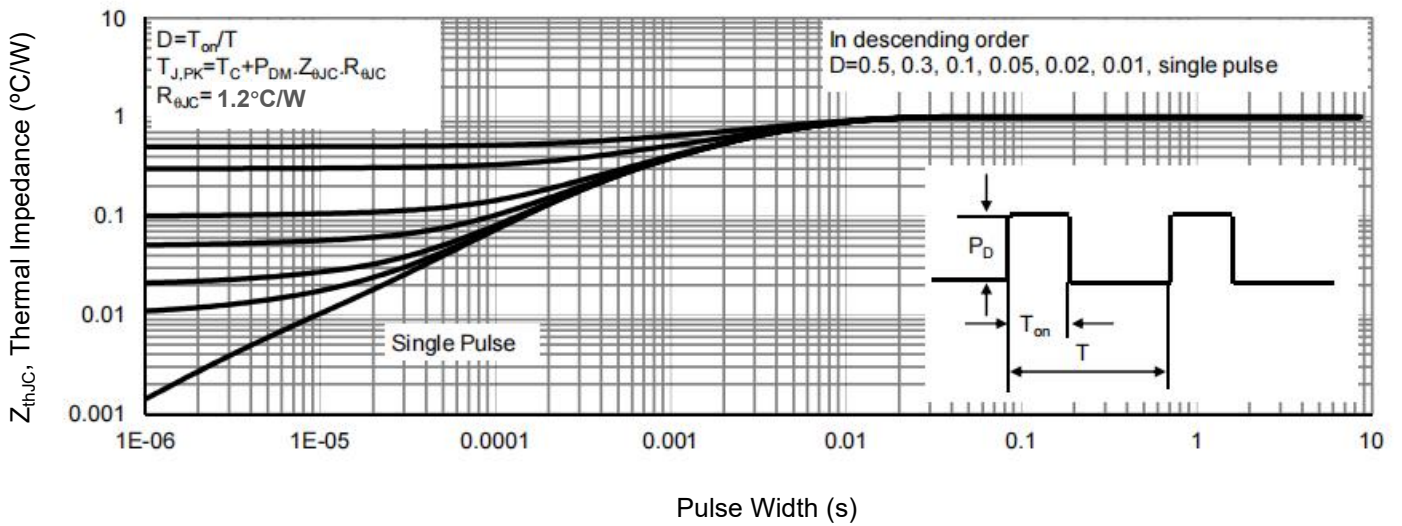
**Figure 7. Drain-Source On-Resistance**



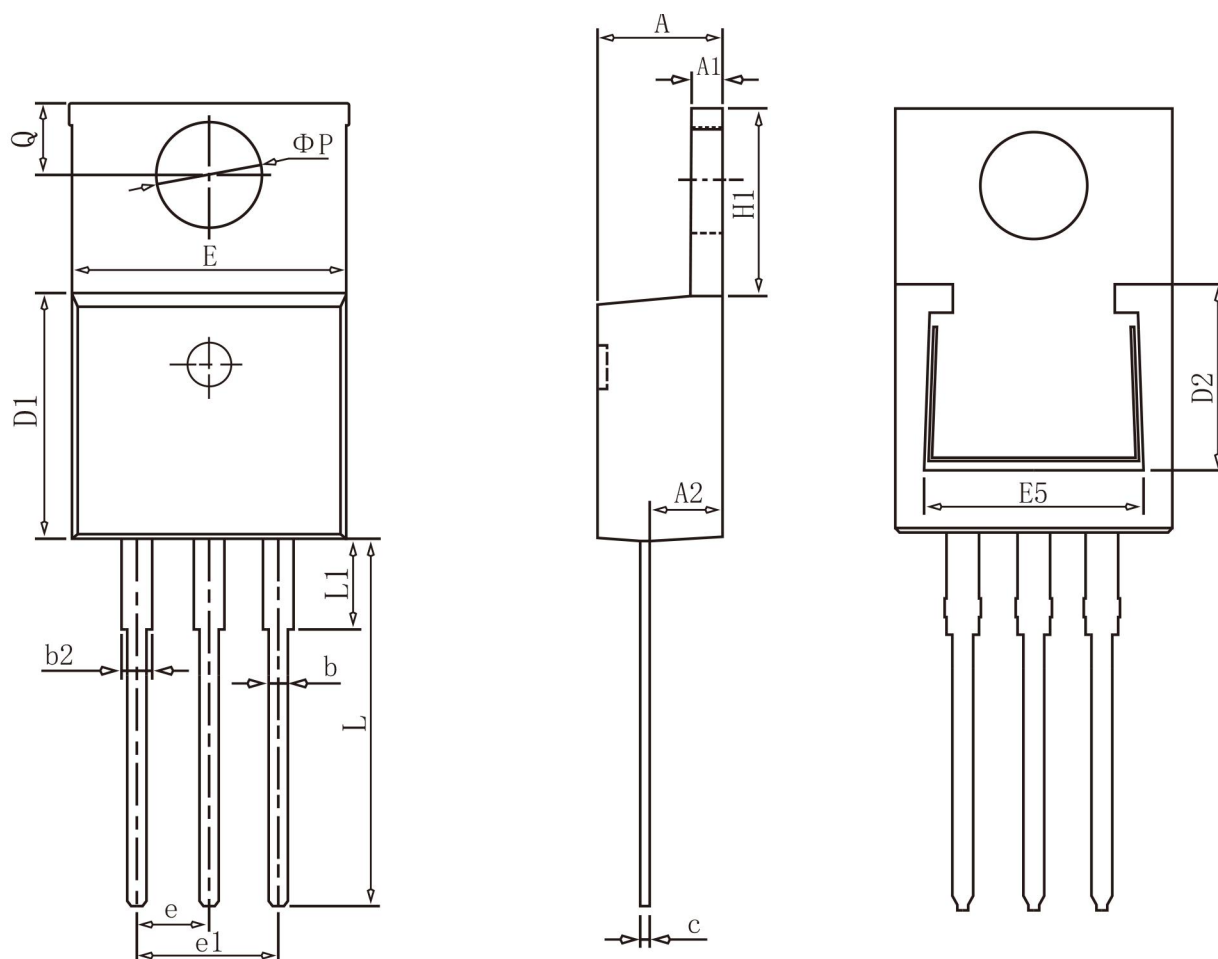
**Figure 8. Safe Operation Area**



**Figure 9. Normalized Maximum Transient Thermal Impedance**



## TO-220 Package Information



### COMMON DIMENSIONS

SYMBOL	mm		
	MIN	NOM	MAX
A	4.37	4.57	4.77
A1	1.22	1.27	1.42
A2	2.49	2.69	2.89
b	0.75	0.81	0.96
b2	1.22	1.27	1.47
c	0.30	0.38	0.48
D1	8.50	8.70	8.90
D2	5.20	-	-
E	9.86	10.16	10.36
E5	7.06	-	-
e	2.54BSC		
e1	5.08BSC		
H1	6.10	6.30	6.50
L	13.10	13.40	13.70
L1	-	3.75	4.10
$\Phi P$	3.70	3.84	3.99
Q	2.54	2.74	2.94