

MBD301G, MMBD301LT1G, MMBD301LT3G, SMMBD301LT3G



ON Semiconductor®

www.onsemi.com

Silicon Hot-Carrier Diodes

Schottky Barrier Diodes

These devices are designed primarily for high-efficiency UHF and VHF detector applications. They are readily adaptable to many other fast switching RF and digital applications. They are supplied in an inexpensive plastic package for low-cost, high-volume consumer and industrial/commercial requirements. They are also available in a Surface Mount package.

Features

- Extremely Low Minority Carrier Lifetime – 15 ps (Typ)
- Very Low Capacitance – 1.5 pF (Max) @ $V_R = 15\text{ V}$
- Low Reverse Leakage – $I_R = 13\text{ nAdc}$ (Typ) MBD301, MMBD301
- S Prefix for Automotive and Other Applications Requiring Unique Site and Control Change Requirements; AEC-Q101 Qualified and PPAP Capable
- These Devices are Pb-Free, Halogen Free/BFR Free and are RoHS Compliant

MAXIMUM RATINGS

Rating	Symbol	Value	Unit
Reverse Voltage	V_R	30	V
Forward Current (DC)	I_F	200 (Max)	mA
Total Device Dissipation @ $T_A = 25^\circ\text{C}$ MBD301G MMBD301LT1G, MMBD301LT3G, SMMBD301LT3G	P_F	280 200	MW
Derate above 25°C MBD301G MMBD301LT1G, MMBD301LT3G, SMMBD301LT3G		2.8 2.0	mW/ $^\circ\text{C}$
Operating Junction Temperature Range	T_J	-55 to +125	$^\circ\text{C}$
Storage Temperature Range	T_{stg}	-55 to +150	$^\circ\text{C}$

Stresses exceeding those listed in the Maximum Ratings table may damage the device. If any of these limits are exceeded, device functionality should not be assumed, damage may occur and reliability may be affected.

30 VOLTS SILICON HOT-CARRIER DETECTOR AND SWITCHING DIODES



TO-92 2-Lead
CASE 182
STYLE 1

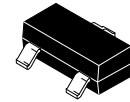

SOT-23 (TO-236)
CASE 318
STYLE 8

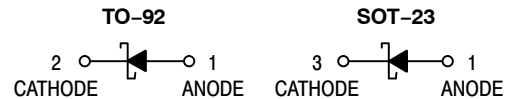

MARKING DIAGRAMS

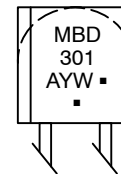

TO-92

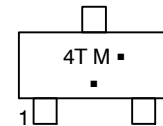

SOT-23

- A = Assembly Location
- Y = Year
- W = Work Week
- 4T = Device Code (SOT-23)
- M = Date Code*
- = Pb-Free Package

(Note: Microdot may be in either location)

*Date Code orientation and/or overbar may vary depending upon manufacturing location.

ORDERING INFORMATION

See detailed ordering and shipping information in the package dimensions section on page 2 of this data sheet.

MBD301G, MMBD301LT1G, MMBD301LT3G, SMMBD301LT3G

ELECTRICAL CHARACTERISTICS (T_A = 25°C unless otherwise noted)

Characteristic	Symbol	Min	Typ	Max	Unit
Reverse Breakdown Voltage (I _R = 10 μA)	V _{(BR)R}	30	–	–	V
Total Capacitance (V _R = 15 V, f = 1.0 MHz) Figure 1	C _T	–	0.9	1.5	pF
Reverse Leakage (V _R = 25 V) Figure 3	I _R	–	13	200	nAdc
Forward Voltage (I _F = 1.0 mAdc) Figure 4	V _F	–	0.38	0.45	Vdc
Forward Voltage (I _F = 10 mAdc) Figure 4	V _F	–	0.52	0.6	Vdc

Product parametric performance is indicated in the Electrical Characteristics for the listed test conditions, unless otherwise noted. Product performance may not be indicated by the Electrical Characteristics if operated under different conditions.

ORDERING INFORMATION

Device	Package	Shipping†
MBD301G	TO-92 (Pb-Free)	5,000 Units / Bulk
MMBD301LT1G	SOT-23 (Pb-Free)	3,000 / Tape & Reel
MMBD301LT3G	SOT-23 (Pb-Free)	10,000 / Tape & Reel
SMMBD301LT3G	SOT-23 (Pb-Free)	10,000 / Tape & Reel

†For information on tape and reel specifications, including part orientation and tape sizes, please refer to our Tape and Reel Packaging Specifications Brochure, BRD8011/D.

TYPICAL ELECTRICAL CHARACTERISTICS

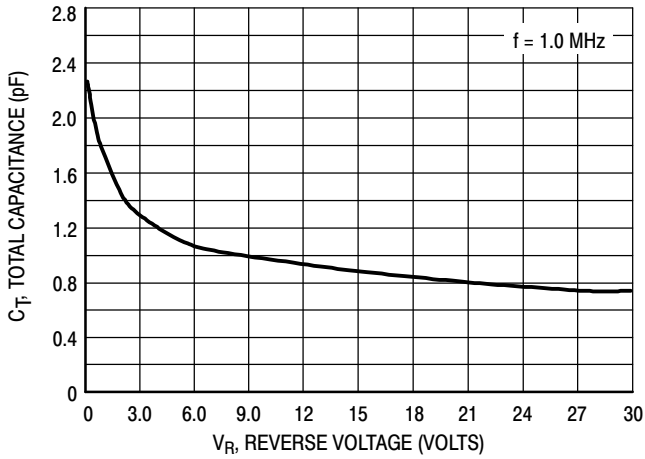

Figure 1. Total Capacitance

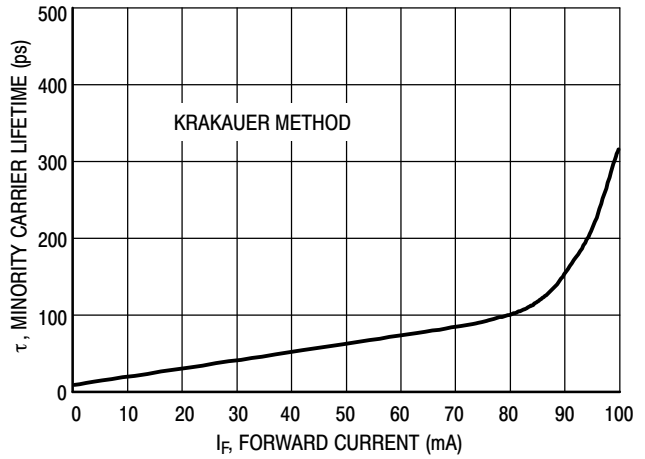

Figure 2. Minority Carrier Lifetime

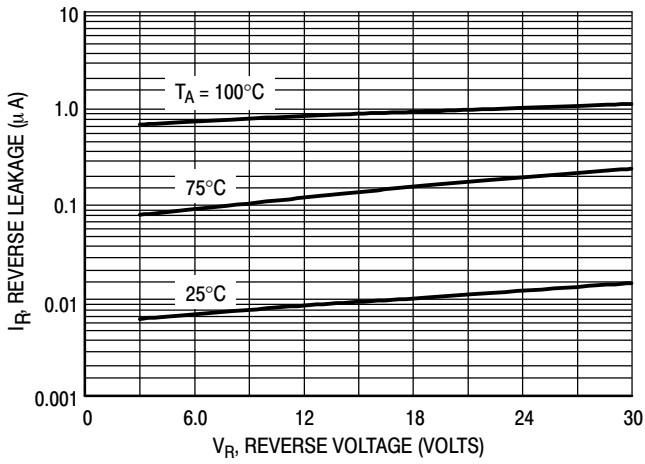

Figure 3. Reverse Leakage

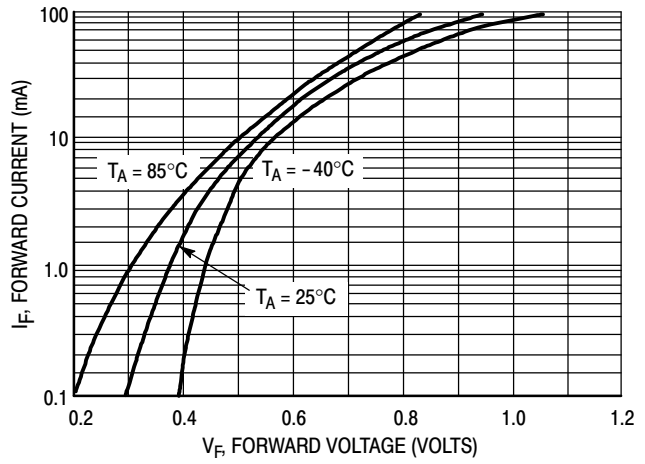

Figure 4. Forward Voltage

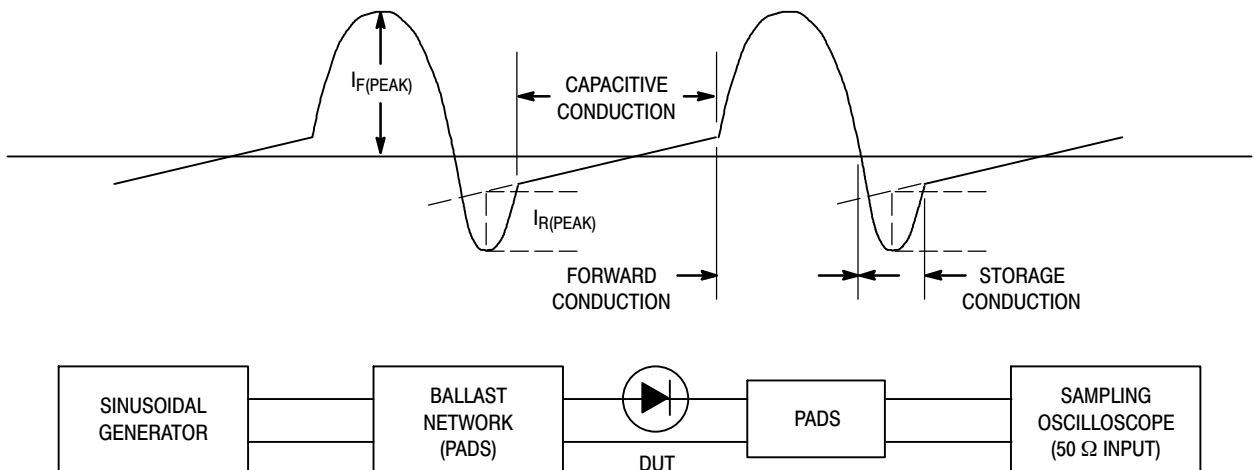

Figure 5. Krakauer Method of Measuring Lifetime



MOTOROLA

MECHANICAL OUTLINES
DICTIONARY

98ASB42118B

PAGE 182

DO NOT SCALE THIS DWG

ALL APPROVAL SIGNATURES ON FILE
IN DOCUMENT CENTRAL

ISSUE L

SHEET 1 OF 2

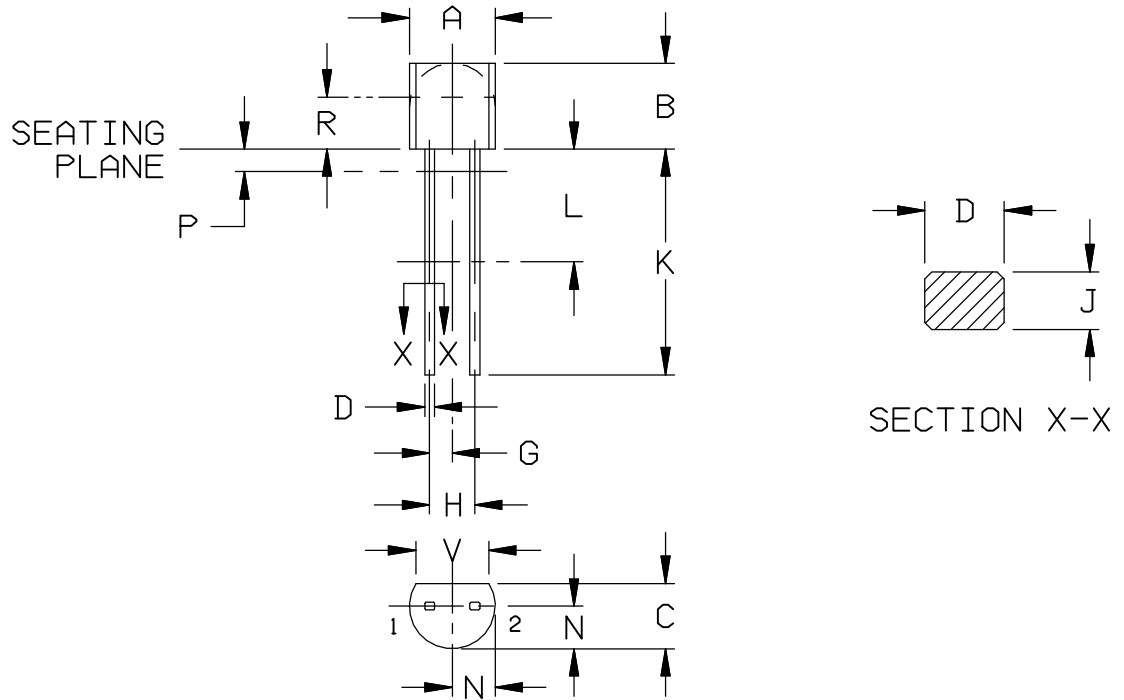

DIM	MILLIMETERS		INCHES	
	MIN	MAX	MIN	MAX
A	4.45	5.21	0.175	0.205
B	4.32	5.33	0.170	0.210
C	3.18	4.19	0.125	0.165
D	0.407	0.533	0.016	0.021
G	1.27	BSC	0.050	BSC
H	2.54	BSC	0.100	BSC
J	0.36	0.41	0.014	0.016
K	12.70	---	0.500	---
L	6.35	---	0.250	---
N	2.03	2.66	0.080	0.105
P	---	1.27	---	0.050
R	2.93	---	0.115	---
V	3.43	---	0.135	---

NOTES:

- DIMENSIONING AND TOLERANCING PER ANSI Y14.5M, 1982.
- CONTROLLING DIMENSION: INCH.
- CONTOUR OF PACKAGE BEYOND ZONE R IS UNCONTROLLED.
- LEAD DIM IS UNCONTROLLED IN P AND BEYOND DIM K MINIMUM.
- 182-01 THRU -04 OBSOLETE, NEW STANDARD 182-06.

STYLE 1:

- PIN 1. ANODE
- CATHODE

STYLE 2:

- PIN 1. CATHODE
- ANODE

STYLE 3:

- PIN 1. MAIN TERM 1
- MAIN TERM 2

STYLE 4: OBSOLETE

STYLE 5:

- PIN 1. INPUT
- OUTPUT

CASE NO.	182-06
STATUS	TO-226AC
NEW STD	
USED ON	VL225 THRU 289

ISSUE	REVISION	COORD/ DATE
J	SH 1: DIM "F" WAS ..407-.482, .016-.019. REQ BY T. GRINTER.	FB 27 JAN1998
K	SH 1 : DIMENSIONS "D", "F" WERE 0.56, 0.022. REQ BY T. GRINTER.	FB 10 FEB 1998
L	DELETED DIM "F" AND REVISED NOTE 4. REQ BY T. GRINTER.	FB 14 APR 1998

MECHANICAL CASE OUTLINE

PACKAGE DIMENSIONS

ON Semiconductor®



SOT-23 (TO-236) CASE 318-08 ISSUE AS

DATE 30 JAN 2018

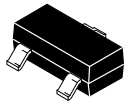

SCALE 4:1

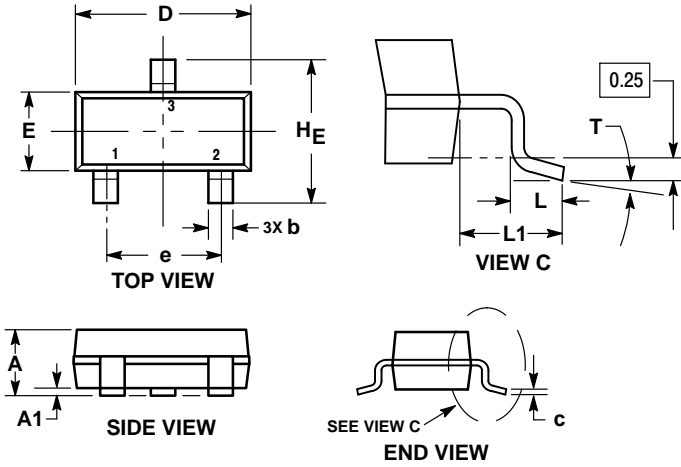

NOTES:

1. DIMENSIONING AND TOLERANCING PER ASME Y14.5M, 1994.
2. CONTROLLING DIMENSION: MILLIMETERS.
3. MAXIMUM LEAD THICKNESS INCLUDES LEAD FINISH. MINIMUM LEAD THICKNESS IS THE MINIMUM THICKNESS OF THE BASE MATERIAL.
4. DIMENSIONS D AND E DO NOT INCLUDE MOLD FLASH, PROTRUSIONS, OR GATE BURRS.

DIM	MILLIMETERS			INCHES		
	MIN	NOM	MAX	MIN	NOM	MAX
A	0.89	1.00	1.11	0.035	0.039	0.044
A1	0.01	0.06	0.10	0.000	0.002	0.004
b	0.37	0.44	0.50	0.015	0.017	0.020
c	0.08	0.14	0.20	0.003	0.006	0.008
D	2.80	2.90	3.04	0.110	0.114	0.120
E	1.20	1.30	1.40	0.047	0.051	0.055
e	1.78	1.90	2.04	0.070	0.075	0.080
L	0.30	0.43	0.55	0.012	0.017	0.022
L1	0.35	0.54	0.69	0.014	0.021	0.027
HE	2.10	2.40	2.64	0.083	0.094	0.104
T	0°	---	10°	0°	---	10°

RECOMMENDED SOLDERING FOOTPRINT

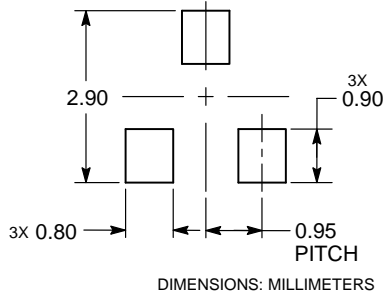

GENERIC MARKING DIAGRAM*

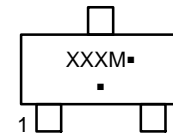

XXX = Specific Device Code
M = Date Code
▪ = Pb-Free Package

(Note: Microdot may be in either location)

*This information is generic. Please refer to device data sheet for actual part marking. Pb-Free indicator, "G" or microdot "▪", may or may not be present.

STYLE 1 THRU 5:
CANCELLED

STYLE 6:
PIN 1. BASE
2. EMITTER
3. COLLECTOR

STYLE 7:
PIN 1. EMITTER
2. BASE
3. COLLECTOR

STYLE 8:
PIN 1. ANODE
2. NO CONNECTION
3. CATHODE

STYLE 9:
PIN 1. ANODE
2. ANODE
3. CATHODE

STYLE 10:
PIN 1. DRAIN
2. SOURCE
3. GATE

STYLE 11:
PIN 1. ANODE
2. CATHODE
3. CATHODE-ANODE

STYLE 12:
PIN 1. CATHODE
2. CATHODE
3. ANODE

STYLE 13:
PIN 1. SOURCE
2. DRAIN
3. GATE

STYLE 14:
PIN 1. CATHODE
2. GATE
3. ANODE

STYLE 15:
PIN 1. GATE
2. CATHODE
3. ANODE

STYLE 16:
PIN 1. ANODE
2. CATHODE
3. CATHODE

STYLE 17:
PIN 1. NO CONNECTION
2. ANODE
3. CATHODE

STYLE 18:
PIN 1. NO CONNECTION
2. CATHODE
3. ANODE

STYLE 19:
PIN 1. CATHODE
2. ANODE
3. CATHODE-ANODE

STYLE 20:
PIN 1. CATHODE
2. ANODE
3. GATE

STYLE 21:
PIN 1. GATE
2. SOURCE
3. DRAIN

STYLE 22:
PIN 1. RETURN
2. OUTPUT
3. INPUT

STYLE 23:
PIN 1. ANODE
2. ANODE
3. CATHODE

STYLE 24:
PIN 1. GATE
2. DRAIN
3. SOURCE

STYLE 25:
PIN 1. ANODE
2. CATHODE
3. GATE

STYLE 26:
PIN 1. CATHODE
2. ANODE
3. NO CONNECTION

STYLE 27:
PIN 1. CATHODE
2. CATHODE
3. CATHODE

STYLE 28:
PIN 1. ANODE
2. ANODE
3. ANODE

DOCUMENT NUMBER:	98ASB42226B	Electronic versions are uncontrolled except when accessed directly from the Document Repository. Printed versions are uncontrolled except when stamped "CONTROLLED COPY" in red.
STATUS:	ON SEMICONDUCTOR STANDARD	
NEW STANDARD:		
DESCRIPTION:	SOT-23 (TO-236)	PAGE 1 OF 2



ISSUE	REVISION	DATE
AJ	ADDED STYLE 27. REQ. BY P. LEM.	07 JUL 2004
AK	OBSOLETE -09 VERSION. REQ. BY D. TRUHITTE.	14 SEP 2004
AL	ADDED NOMINAL VALUES AND UPDATED GENERIC MARKING DIAGRAM. REQ. BY HONG XIAO.	27 MAY 2005
AM	REDREW LEAD SIDE VIEW. REQ BY DARRELL TRUHITTE.	26 AUG 2005
AN	REINTRODUCED LABELS FOR DIMENSION C. REQ. BY D. TRUHITTE.	14 OCT 2005
AP	ADDED THETA DEGREE VALUES TO DIMENSION TABLE. REQ. BY D. TRUHITTE.	17 NOV 2009
AR	MODIFIED DIMENSIONS C AND L. REQ. BY M. YOU.	10 OCT 2016
AS	ADDED STYLE 28. REQ. BY E. ESTILLER.	30 JAN 2018

ON Semiconductor and  are registered trademarks of Semiconductor Components Industries, LLC (SCILLC). SCILLC reserves the right to make changes without further notice to any products herein. SCILLC makes no warranty, representation or guarantee regarding the suitability of its products for any particular purpose, nor does SCILLC assume any liability arising out of the application or use of any product or circuit, and specifically disclaims any and all liability, including without limitation special, consequential or incidental damages. "Typical" parameters which may be provided in SCILLC data sheets and/or specifications can and do vary in different applications and actual performance may vary over time. All operating parameters, including "Typicals" must be validated for each customer application by customer's technical experts. SCILLC does not convey any license under its patent rights nor the rights of others. SCILLC products are not designed, intended, or authorized for use as components in systems intended for surgical implant into the body, or other applications intended to support or sustain life, or for any other application in which the failure of the SCILLC product could create a situation where personal injury or death may occur. Should Buyer purchase or use SCILLC products for any such unintended or unauthorized application, Buyer shall indemnify and hold SCILLC and its officers, employees, subsidiaries, affiliates, and distributors harmless against all claims, costs, damages, and expenses, and reasonable attorney fees arising out of, directly or indirectly, any claim of personal injury or death associated with such unintended or unauthorized use, even if such claim alleges that SCILLC was negligent regarding the design or manufacture of the part. SCILLC is an Equal Opportunity/Affirmative Action Employer. This literature is subject to all applicable copyright laws and is not for resale in any manner.

ON Semiconductor and  are trademarks of Semiconductor Components Industries, LLC dba ON Semiconductor or its subsidiaries in the United States and/or other countries. ON Semiconductor owns the rights to a number of patents, trademarks, copyrights, trade secrets, and other intellectual property. A listing of ON Semiconductor's product/patent coverage may be accessed at www.onsemi.com/site/pdf/Patent-Marking.pdf. ON Semiconductor reserves the right to make changes without further notice to any products herein. ON Semiconductor makes no warranty, representation or guarantee regarding the suitability of its products for any particular purpose, nor does ON Semiconductor assume any liability arising out of the application or use of any product or circuit, and specifically disclaims any and all liability, including without limitation special, consequential or incidental damages. Buyer is responsible for its products and applications using ON Semiconductor products, including compliance with all laws, regulations and safety requirements or standards, regardless of any support or applications information provided by ON Semiconductor. "Typical" parameters which may be provided in ON Semiconductor data sheets and/or specifications can and do vary in different applications and actual performance may vary over time. All operating parameters, including "Typicals" must be validated for each customer application by customer's technical experts. ON Semiconductor does not convey any license under its patent rights nor the rights of others. ON Semiconductor products are not designed, intended, or authorized for use as a critical component in life support systems or any FDA Class 3 medical devices or medical devices with a same or similar classification in a foreign jurisdiction or any devices intended for implantation in the human body. Should Buyer purchase or use ON Semiconductor products for any such unintended or unauthorized application, Buyer shall indemnify and hold ON Semiconductor and its officers, employees, subsidiaries, affiliates, and distributors harmless against all claims, costs, damages, and expenses, and reasonable attorney fees arising out of, directly or indirectly, any claim of personal injury or death associated with such unintended or unauthorized use, even if such claim alleges that ON Semiconductor was negligent regarding the design or manufacture of the part. ON Semiconductor is an Equal Opportunity/Affirmative Action Employer. This literature is subject to all applicable copyright laws and is not for resale in any manner.

PUBLICATION ORDERING INFORMATION

LITERATURE FULFILLMENT:

Literature Distribution Center for ON Semiconductor
19521 E. 32nd Pkwy, Aurora, Colorado 80011 USA
Phone: 303-675-2175 or 800-344-3860 Toll Free USA/Canada
Fax: 303-675-2176 or 800-344-3867 Toll Free USA/Canada
Email: orderlit@onsemi.com

N. American Technical Support: 800-282-9855 Toll Free
USA/Canada
Europe, Middle East and Africa Technical Support:
Phone: 421 33 790 2910

ON Semiconductor Website: www.onsemi.com

Order Literature: <http://www.onsemi.com/orderlit>

For additional information, please contact your local
Sales Representative