

ignion 

Your innovation.
Accelerated.

COMPACT REACH Xtend™ (NN01-102)

USER MANUAL
COMPACT REACH Xtend™ (NN01-102)

Compact Reach Xtend™ (NN01-102) – Bluetooth®, Zigbee®, 802.11 b/g/n WLAN

Ignion specializes in enabling effective mobile communications. Using Ignion technology, we design and manufacture optimized antennas to make your wireless devices more competitive. Our mission is to help our clients develop innovative products and accelerate their time to market through our expertise in antenna design, testing and manufacturing.



Compact Reach Xtend™

NN01-102

Ignion products are protected by [Ignion patents](#).

All information contained within this document is property of Ignion and is subject to change without prior notice. Information is provided “as is” and without warranties. It is prohibited to copy or reproduce this information without prior approval.

Ignion is an ISO 9001:2015 certified company. All our antennas are lead-free and RoHS compliant.

ISO 9001: 2015 Certified



INDEX OF CHAPTERS

1. ANTENNA DESCRIPTION	5
2. QUICK REFERENCE GUIDE	5
3. ELECTRICAL PERFORMANCE	6
4. MECHANICAL CHARACTERISTICS	10
5. ASSEMBLY PROCESS	12
6. PACKAGING	14
7. PRODUCT CHANGE NOTIFICATION	15

TABLE OF CONTENTS

1. ANTENNA DESCRIPTION	5
2. QUICK REFERENCE GUIDE	5
3. ELECTRICAL PERFORMANCE	6
3.1. EVALUATION BOARD	6
3.2. MATCHING NETWORK	6
3.3. VSWR AND EFFICIENCY	7
3.4. RADIATION PATTERNS (2.4 – 2.5 GHz), GAIN AND EFFICIENCY	8
3.5. CAPABILITIES AND MEASUREMENT SYSTEMS	9
4. MECHANICAL CHARACTERISTICS	10
4.1. DIMENSIONS AND TOLERANCES	10
4.2. SPECIFICATIONS FOR THE INK	10
4.3. ANTENNA FOOTPRINT	11
5. ASSEMBLY PROCESS	12
6. PACKAGING	14
7. PRODUCT CHANGE NOTIFICATION	15

1. ANTENNA DESCRIPTION

The Compact Reach Xtend™ chip antenna is engineered specifically for Bluetooth®, WLAN 802.11 b/g/n and other wireless devices operating at the ISM 2.4 GHz band. Compact Reach Xtend™ combines small form factor size and high performance to improve the functionality of your wireless devices.

The Compact Reach Xtend™ is a low-cost antenna solution that combines small form factor and high performance with integration flexibility making it ideal for small consumer electronics devices such as wireless headsets and USB dongles.

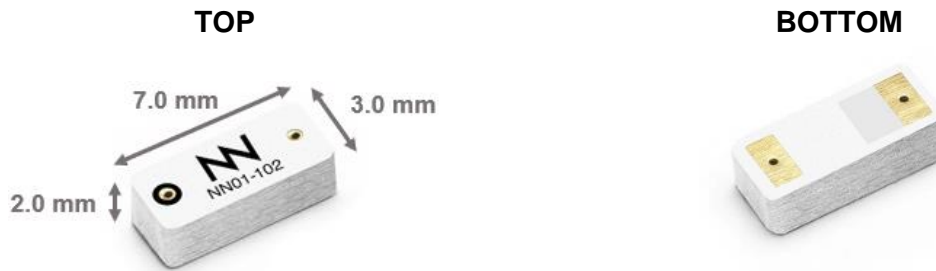

Material: The Compact Reach Xtend™ antenna is built on glass epoxy substrate.

APPLICATIONS

- Headsets, Headphones
- Medical devices
- Modules WiFi, Bluetooth, Zigbee...
- USB Dongles
- Sensors (bike speed, telemetry...)
- Military
- Digital cameras

BENEFITS

- High efficiency and gain
- Cost-effective
- Small footprint
- Easy to use (pick and place)

2. QUICK REFERENCE GUIDE

Technical Features	2.4 – 2.5 GHz
Average Efficiency	72.2 %
Peak Gain	1.7 dBi
VSWR	< 2:1
Radiation Pattern	Omnidirectional
Polarization	Linear
Weight (approx.)	0.1 g
Temperature	-40 to +125° C
Impedance	50 Ω
Dimensions (L x W x H)	7.0 mm x 3.0 mm x 2.0 mm

Table 1 – Technical Features. Measures from the evaluation. See Figure 1 and picture on page 6.

Please contact support@ignion.io if you require additional information on antenna integration or optimization on your PCB.

3. ELECTRICAL PERFORMANCE

3.1. EVALUATION BOARD

The Ignion configuration used in testing the Compact Reach Xtend™ chip antenna is displayed in Figure 1.

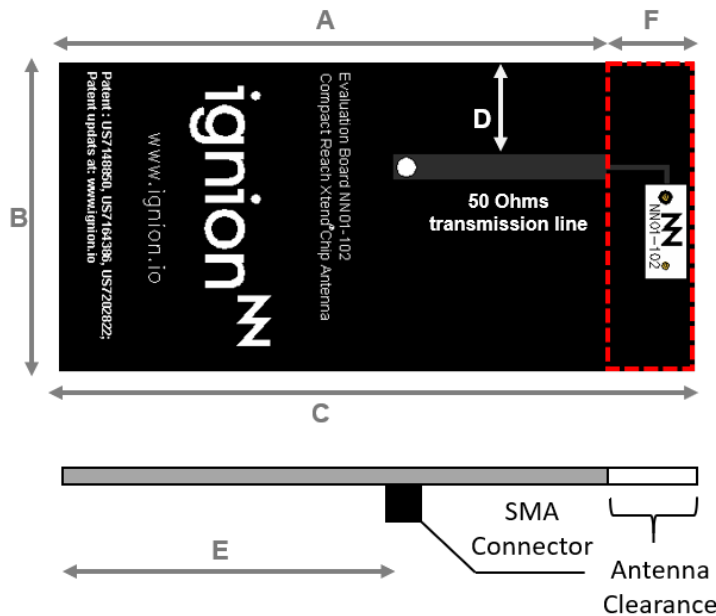

Tolerance: ±0.2mm

Measure	mm
A	41.0
B	23.0
C	47.0
D	8.0
E	26.0
F	6.5

Material: The evaluation board is built on FR4 substrate. Thickness is 1.0mm.

Clearance Area: 23.0 mm x 6.5 mm (BxF)

Figure 1 – EB_NN01-102. Compact Reach Xtend™ Evaluation Board.

3.2. MATCHING NETWORK

The specs of a Ignion standard antenna are measured in their evaluation board, which is an ideal case. In a real design, components nearby the antenna, LCD's, batteries, covers, connectors, etc. affect the antenna performance. This is the reason why it is highly recommended placing pads compatible with 0402 and 0603 SMD components for a PI matching network as close as possible to the antenna feeding point. Do it in the ground plane area, not in the clearance area. This is a degree of freedom to tune the antenna once the design is finished and taking into account all elements of the system (batteries, displays, covers, etc.).

Please notice that different devices with different ground planes and different components nearby the Compact Reach Xtend™ chip antenna may need a different matching network. To ensure optimal results, the use of high Q and tight tolerance components is highly recommended (Murata components). If you need assistance to design your matching network beyond this application note, please contact support@ignion.io, or try our free-of-charge¹ **NN Wireless Fast-Track** design service, you will get your chip antenna design including a custom matching network for your device in 24h¹. Other related to NN's range of R&D services is available at: <https://www.ignion.io/rdservices/>

¹ See terms and conditions for a free NN Wireless Fast-Track service in 24h at: <https://www.ignion.io/fast-track-project/>

3.3. VSWR AND EFFICIENCY

VSWR (Voltage Standing Wave Ratio) and Total Efficiency versus Frequency (GHz).

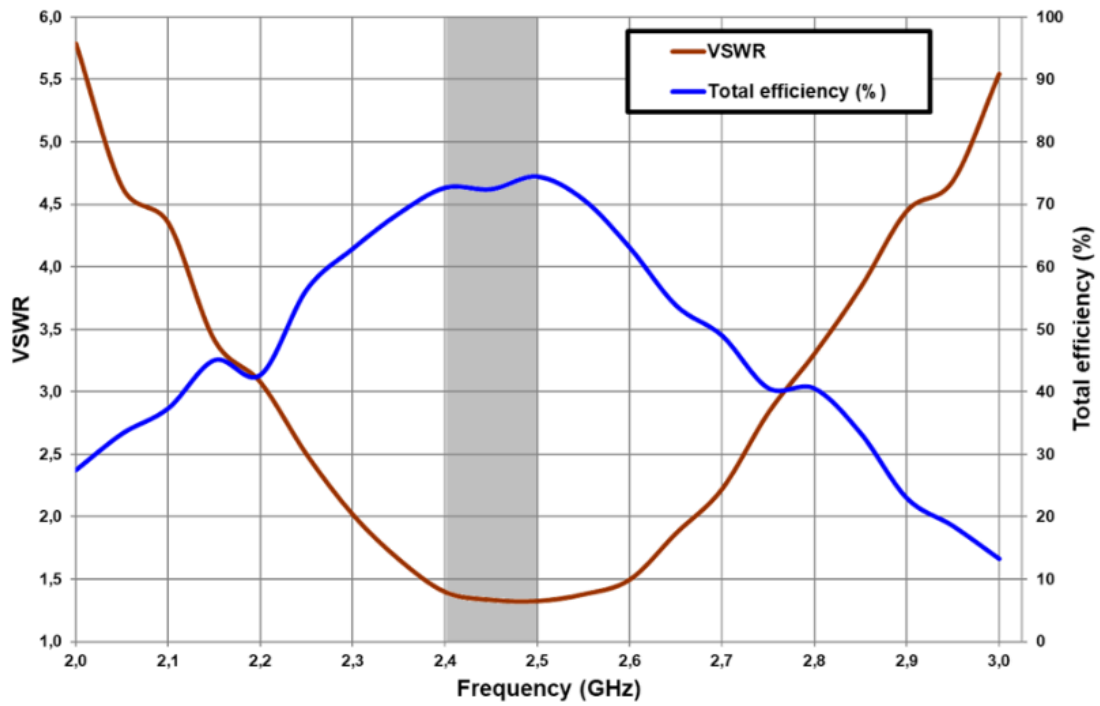
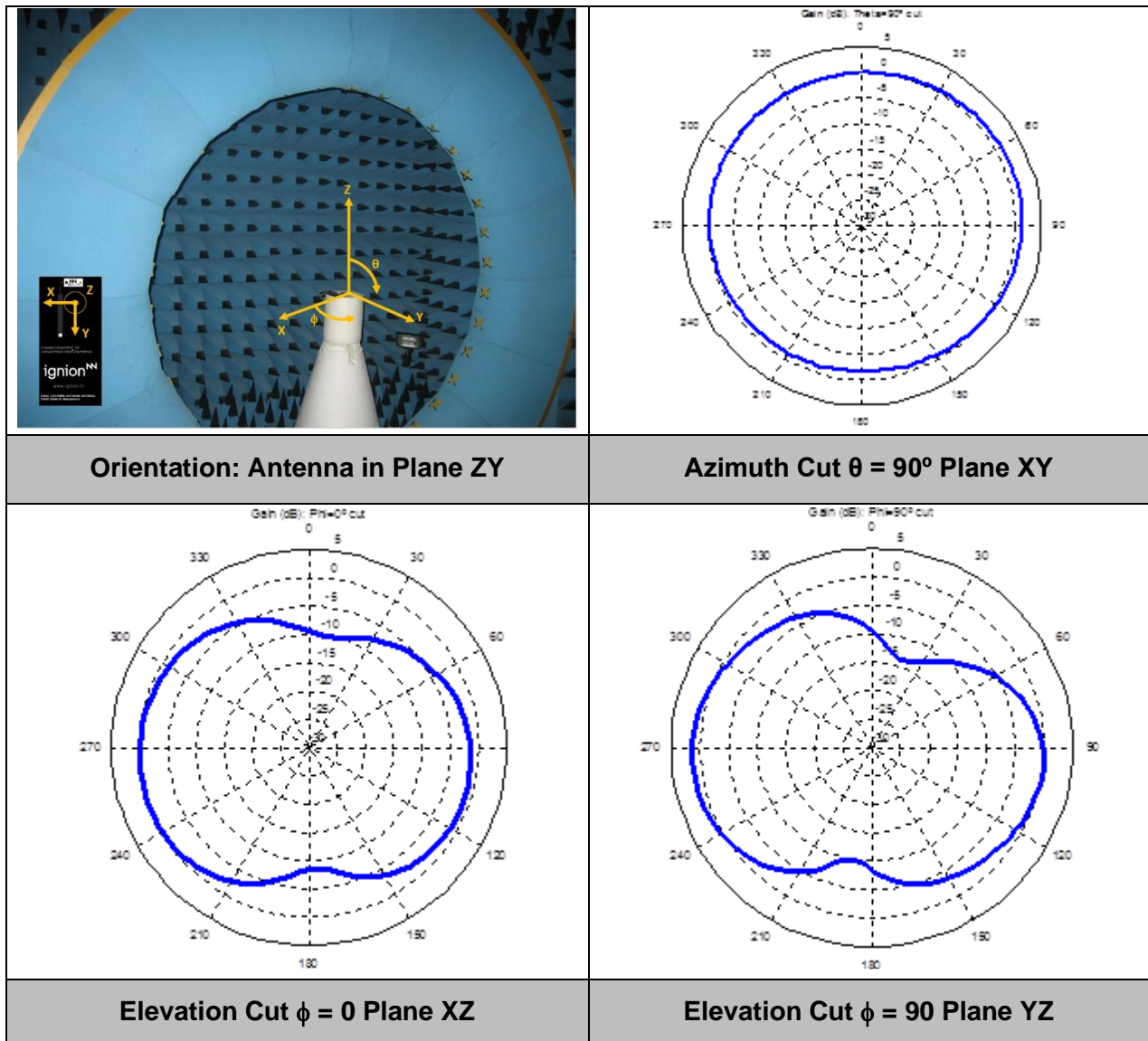

Figure 2 – VSWR and Efficiency (%) vs. Frequency (GHz).

3.4. RADIATION PATTERNS (2.4 – 2.5 GHz), GAIN AND EFFICIENCY



Gain	Peak Gain	1.7 dBi
	Average Gain across the band	1.2 dBi
	Gain Range across the band (min, max)	0.7 \leftrightarrow 1.7 dBi
Efficiency	Peak Efficiency	75.7 %
	Average Efficiency across the band	72.2 %
	Efficiency Range across the band (min, max)	68.9 – 75.7 %

Table 2 – Antenna Gain and Efficiency within the 2.4 – 2.5 GHz band. Measures made in the evaluation board and in the Satimo STARGATE 32 anechoic chamber.

3.5. CAPABILITIES AND MEASUREMENT SYSTEMS

Ignion specializes in the design and manufacture of optimized antennas for wireless applications, and with the provision of RF expertise to a wide range of clients. We offer turn-key antenna products and antenna integration support to minimize your time requirements and maximize return on investment throughout the product development process. We also provide our clients with the opportunity to leverage our in-house testing and measurement facilities to obtain accurate results quickly and efficiently.



Agilent E5071B

VSWR
&
S Parameters

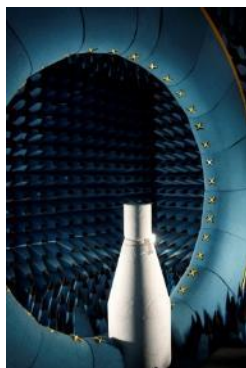
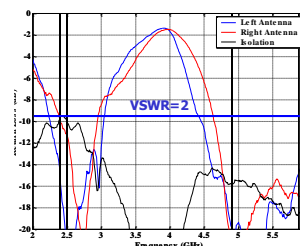

SATIMO STARGATE 32

Radiation
Pattern
&
Efficiency

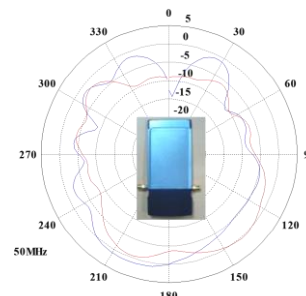

Anechoic chambers and full equipped in-house lab

4. MECHANICAL CHARACTERISTICS

4.1. DIMENSIONS AND TOLERANCES

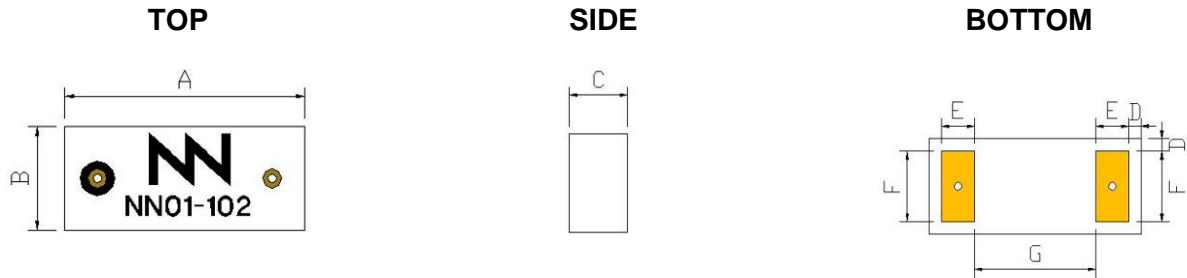

The black circle located on the top side of the antenna indicates the feed pad.

Measure	mm	Measure	mm
A	7.0 ± 0.2	E	1.1 ± 0.1
B	3.0 ± 0.2	F	2.2 ± 0.1
C	2.0 ± 0.2	G	4.0 ± 0.2
D	0.4 ± 0.15		

Figure 3 – Antenna Dimensions and Tolerances.

The Compact Reach Xtend™ chip antenna is compliant with the restriction of the use of hazardous substances (**RoHS**). The RoHS certificate can be downloaded from www.ignion.io.

4.2. SPECIFICATIONS FOR THE INK

Next figure shows the correct colors of the antenna:

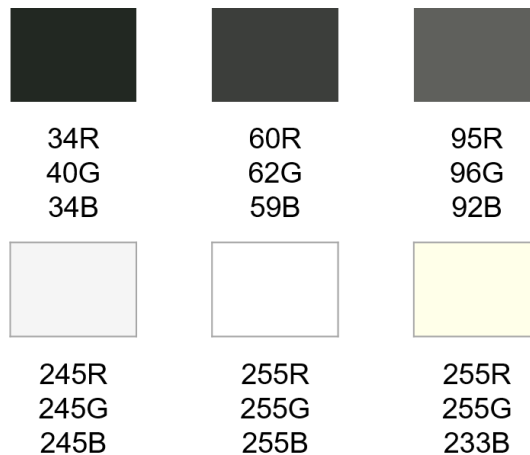

Acceptable color range

4.3. ANTENNA FOOTPRINT

This antenna footprint applies for the reference evaluation board described on page 6 of this User Manual. Feeding line dimensions over the clearance zone described in Figure 4 apply for a 1.0 mm thickness FR4 PCB.

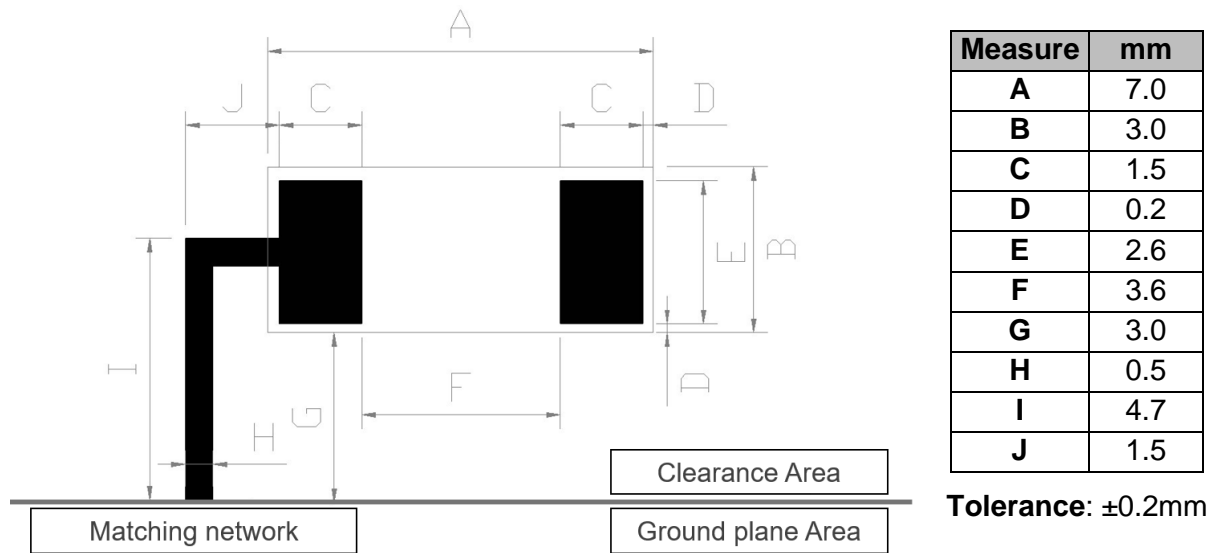

Figure 4 – Antenna Footprint Details.

Other PCB form factors and configurations may require a different feeding configuration, feeding line dimensions and clearance areas. If you require support for the integration of the antenna in your design, please contact support@ignion.io

5. ASSEMBLY PROCESS

Figure 5 shows the back and front view of the Compact Reach Xtend[™] chip antenna, and indicates the location of the feeding point and the mounting pads:

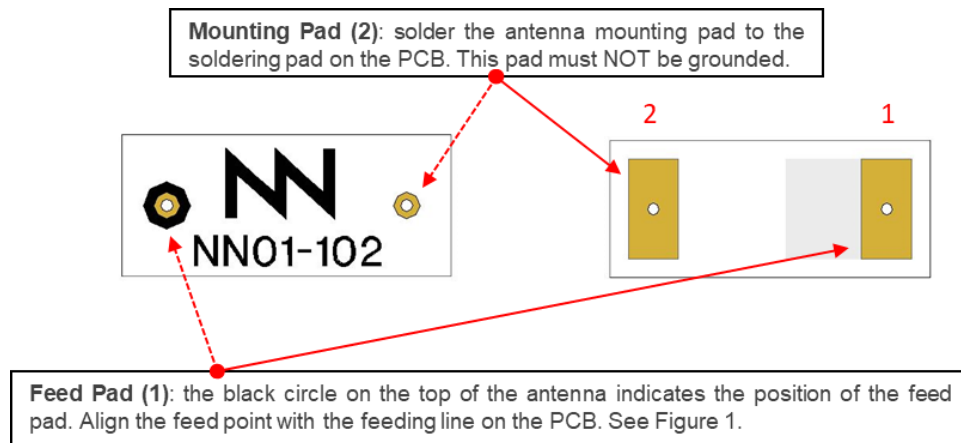

Figure 5 – Pads of the Compact Reach Xtend[™] chip antenna.

As a surface mount device (SMD), this antenna is compatible with industry standard soldering processes. The basic assembly procedure for this antenna is as follows:

1. Apply a solder paste to the pads of the PCB. Place the antenna on the board.
2. Perform a reflow process according to the temperature profile detailed in Table 3, Figure 7 on page 13.
3. After soldering the antenna to the circuit board, perform a cleaning process to remove any residual flux. Ignion recommends conducting a visual inspection after the cleaning process to verify that all reflux has been removed.

The drawing below shows the soldering details obtained after a correct assembly process:

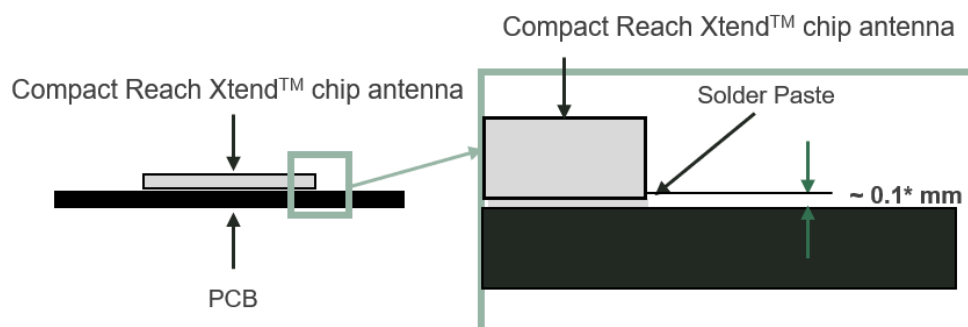

Figure 6 – Soldering Details.

NOTE(*): Solder paste thickness after the assembly process will depend on the thickness of the soldering stencil mask. A stencil thickness equal to or larger than **127 microns (5 mils)** is required.

The Compact Reach Xtend[™] antenna should be assembled following either Sn-Pb or Pb-free assembly processes. According to the Standard **IPC/JEDEC J-STD-020C**, the temperature profile suggested is as follows:

Phase	Profile features	Pb-Free Assembly (SnAgCu)
RAMP-UP	Avg. Ramp-up Rate (T _{smax} to T _p)	3 °C / second (max.)
PREHEAT	- Temperature Min (T _{smin}) - Temperature Max (T _{smax}) - Time (t _{smin} to t _{smax})	150 °C 200 °C 60-180 seconds
REFLOW	- Temperature (T _L) - Total Time above T _L (t _L)	217 °C 60-150 seconds
PEAK	- Temperature (T _p) - Time (t _p)	260 °C 20-40 seconds
RAMP-DOWN	Rate	6 °C/second max
Time from 25 °C to Peak Temperature		8 minutes max

Table 3 – Recommended soldering temperatures.

Next graphic shows temperature profile (grey zone) for the antenna assembly process in reflow ovens.

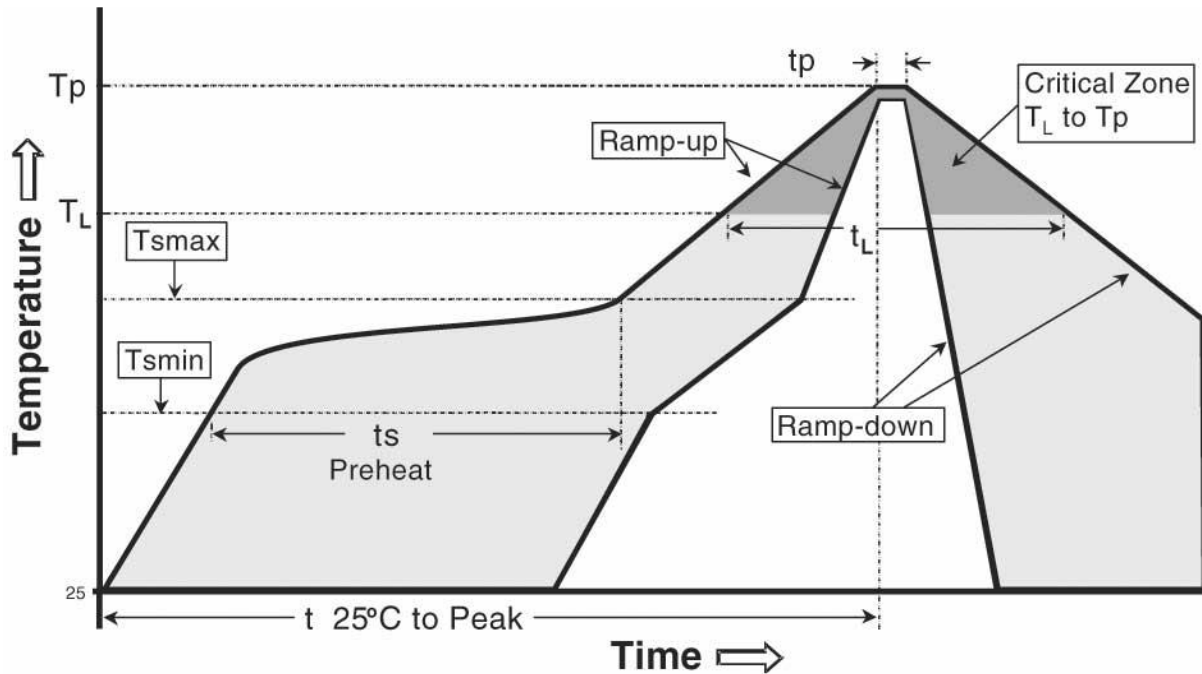
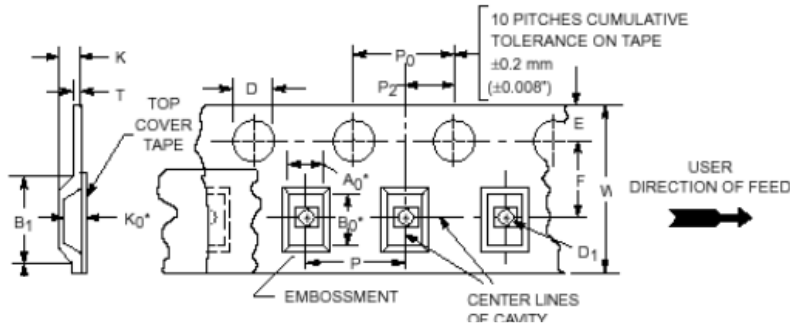

Figure 7 – Temperature profile.

6. PACKAGING

The Compact Reach Xtend™ chip antenna is available in tape and reel packaging.



Measure	mm
W	16.0 ± 0.3
A0	3.6 ± 0.1
B0	7.5 ± 0.1
K0	2.5 ± 0.1
B1	8.1 ± 0.1
D	1.55 ± 0.05
D1	1.55 ± 0.05
Wmax	16.3
E	1.7 ± 0.1
F	7.5 ± 0.1
K	2.8 ± 0.1
P	8.0 ± 0.1
P0	4.0 ± 0.1
P2	2.0 ± 0.1

Figure 8 – Tape Dimensions and Tolerances.

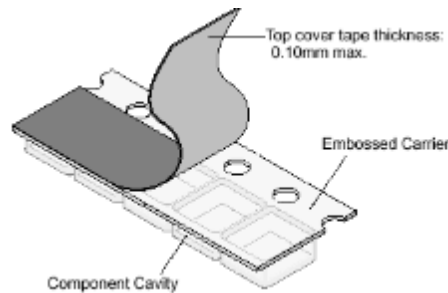
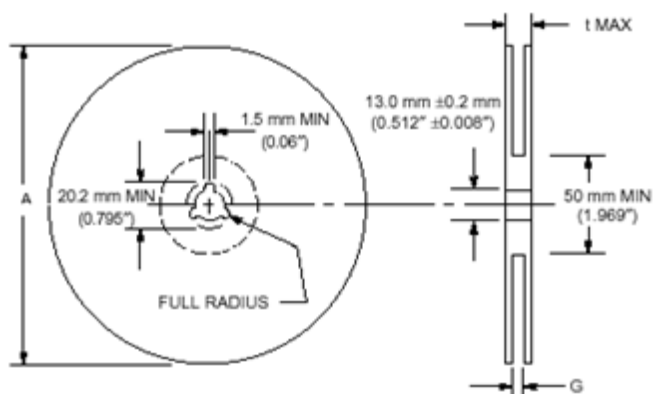

Figure 9 – Images of the tape.



Measure	mm
A max	330.0 ± 1.0
G	17.5 ± 0.2
t max	21.5 ± 0.2

Reel Capacity: 2500 antennas

Figure 10 – Reel Dimensions and Capacity.

7. PRODUCT CHANGE NOTIFICATION

This document is property of Ignion,
Not to disclose or copy without prior written consent

PCN Number: NN19100002

Notification Date: October 07th, 2019

Part Number identification:

Part Number changes, it will be applied in all the document of the company (User Manual, Data Sheet, ...)

Previous Part Number
FR05-S1-N-0-102

New Part Number
NN01-102

Reason for Change:

- | | |
|--|--|
| <input type="checkbox"/> Specs (electrical/mechanical) | <input type="checkbox"/> Manufacturing location |
| <input type="checkbox"/> User Manual/Data Sheet | <input type="checkbox"/> Quality/Reliability |
| <input type="checkbox"/> Material/Composition | <input type="checkbox"/> Logistics |
| <input type="checkbox"/> Processing/Manufacturing | <input checked="" type="checkbox"/> Other: Logo, product color and Part Number |

Change description

- 1.- Part Number: From FR05-S1-N-0-102 FRACTUS to NN01-102 Ignion in the User Manual
- 2.- Color: From blue/white to white/black

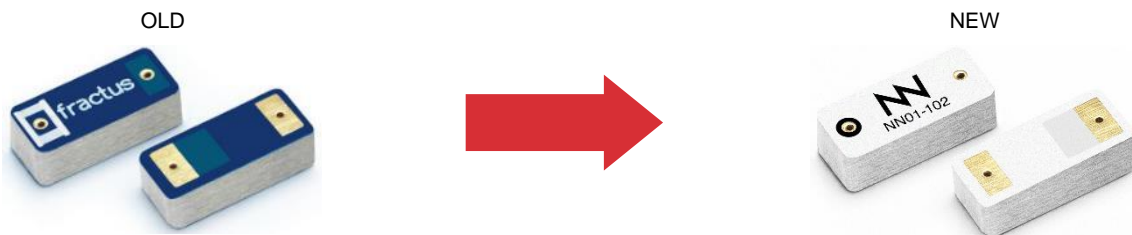

Comments:

- 1.- Electrical and Mechanical specs remain the same
- 2.- Footprint in the PCB to solder the chip antenna remains the same

Identification method

- 1.- In the chip antennas, the changes are in the color, in the logo and in the part number

User Manual	<input checked="" type="checkbox"/>	Available from: March 2020
Samples	<input checked="" type="checkbox"/>	Available from: February 2020

Ignion Contact:

Sales
Name: Josep Portabella
Email: josep.portabella@ignion.io

Supply Chain
Albert Vidal
albert.vidal@ignion.io



Your innovation.
Accelerated.

Contact:

support@ignion.io

+34 935 660 710

Barcelona

Av. Alcalde Barnils, 64-68 Modul C, 3a pl.
Sant Cugat del Vallés
08174 Barcelona
Spain

Shanghai

Shanghai Bund Centre
18/F Bund Centre, 222 Yan'an Road East,
Huangpu District
Shanghai, 200002
China

New Dehli

New Delhi, Red Fort Capital Parsvnath Towers
Bhai Veer Singh Marg, Gole Market,
New Delhi, 110001
India

Tampa

8875 Hidden River Parkway
Suite 300
Tampa, FL 33637
USA