

XACB08

Harmony XAC, Empty pendant control station, plastic, yellow, 8 cut-outs, for cable Ø 10...22 mm



Main

Range of Product	Harmony XAC
Product or Component Type	Pendant control station
Device short name	XACB

Complementary

Control station type	Double insulated
Enclosure Material	Glass reinforced polyester
Electrical circuit type	Power circuit Control circuit
Enclosure type	Empty enclosure
Number of cut-out	8 cut-outs
Control station colour	Yellow
Cable entry	Rubber sleeve with stepped entry 0.39...0.87 in (10...22 mm)
Guard rail	Without
Vertical operator cut-out centre	1.57 in (40 mm)
Standards	EN/IEC 60947-5-1 CSA C22.2 No 14
Product Certifications	CSA type 4
Protective treatment	TH
Ambient air temperature for operation	-13...158 °F (-25...70 °C)
Ambient Air Temperature for Storage	-40...158 °F (-40...70 °C)
Vibration resistance	15 gn 10...500 Hz)IEC 60068-2-6
Shock resistance	100 gn IEC 60068-2-27
Overvoltage category	Class II IEC 61140
IP degree of protection	IP65 conforming to IEC 60529
IK degree of protection	IK08 EN 50102
Mechanical durability	1000000 cycles
Net Weight	2.93 lb(US) (1.33 kg)

Ordering and shipping details

Category	22473 - PUSHBUTTON, PENDANTS
Discount Schedule	CS2
GTIN	3389110640540
Nbr. of units in pkg.	1
Package weight(Lbs)	3.01 lb(US) (1.366 kg)
Returnability	Yes
Country of origin	CZ

Packing Units

Unit Type of Package 1	PCE
Package 1 Height	4.02 in (10.2 cm)
Package 1 width	4.41 in (11.2 cm)
Package 1 Length	27.40 in (69.6 cm)
Unit Type of Package 2	P06
Number of Units in Package 2	25
Package 2 Weight	106.22 lb(US) (48.18 kg)
Package 2 Height	28.94 in (73.5 cm)
Package 2 width	23.62 in (60 cm)
Package 2 Length	31.50 in (80 cm)

Offer Sustainability

California proposition 65	WARNING: This product can expose you to chemicals including: Nickel compounds, which is known to the State of California to cause cancer, and Di-isodecyl phthalate (DIDP), which is known to the State of California to cause birth defects or other reproductive harm. For more information go to www.P65Warnings.ca.gov
REACH Regulation	REACH Declaration
REACH free of SVHC	Yes
EU RoHS Directive	Pro-active compliance (Product out of EU RoHS legal scope) EU RoHS Declaration
Toxic heavy metal free	Yes
Mercury free	Yes
RoHS exemption information	Yes
China RoHS Regulation	China RoHS Declaration

Contractual warranty

Warranty	18 months
----------	-----------

Dimensions

Below drawing shows a product with 6 cut-outs. Select the number of cut-outs according to the product characteristics in order to get b, b1 and c dimensions.

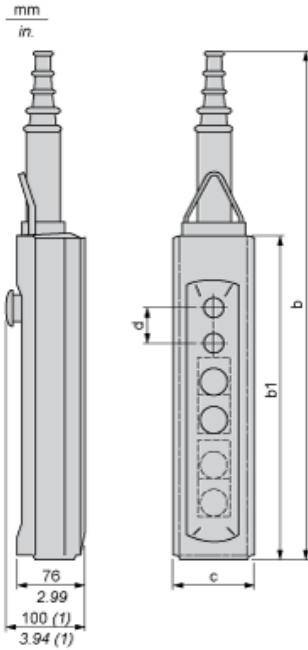

(1) With mushroom head operator

Dimensions in mm

Number of cut-outs	2	4	6	8	12
b	409	499	589	679	679
b1	220	310	400	490	490
c	98	98	98	98	98
d	40	40	40	40	30

Dimensions in in.

Number of cut-outs	2	4	6	8	12
b	16.10	19.64	23.19	26.73	26.73
b1	8.66	12.20	15.75	19.29	19.29
c	3.86	3.86	3.86	3.86	3.86
d	1.57	1.57	1.57	1.57	1.18

Protective cable sleeves

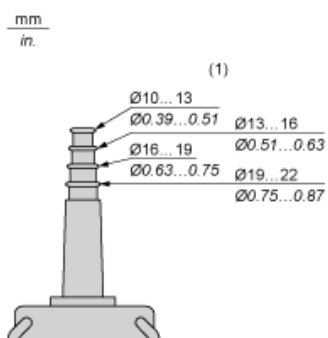

(1) Internal Ø

Control of Single-Speed Reversing Motor

With XESD1181 contact block, to be ordered separately

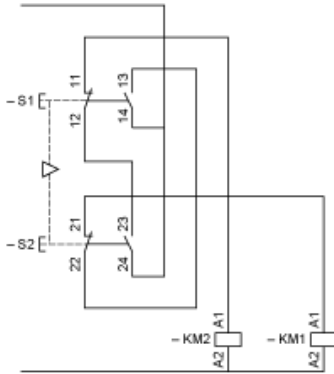

Control of 2-Speed Reversing Motor

With XESD1281 contact block, to be ordered separately

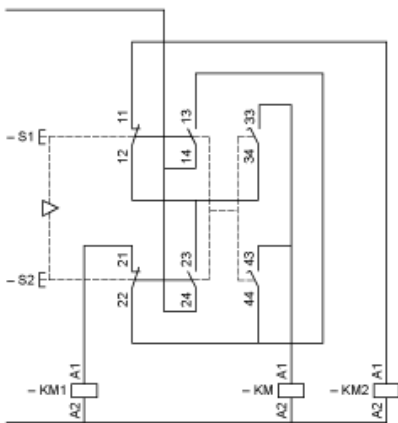

KM High speed contactor

Control of Single-Speed Reversing Motor 2-Phase Switching

With XESD1191 contact block, to be ordered separately

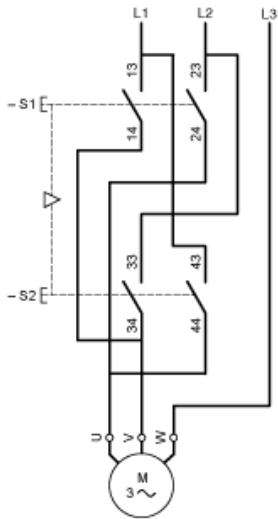

Combined with 3-pole isolating block XACS399 or XACS3991, shown in the unoperated position (pendant station “supplied”), fitted with key release trigger action latching Emergency stop operator.

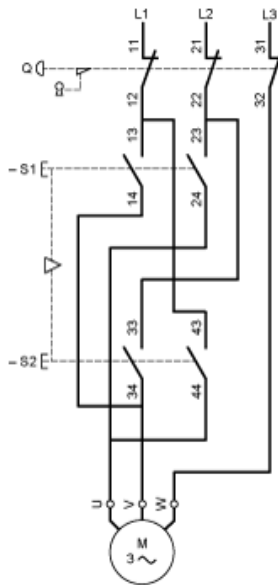

Control of 2-Speed Reversing Motor 2-Phase Switching

With XESD1291 contact block, to be ordered separately

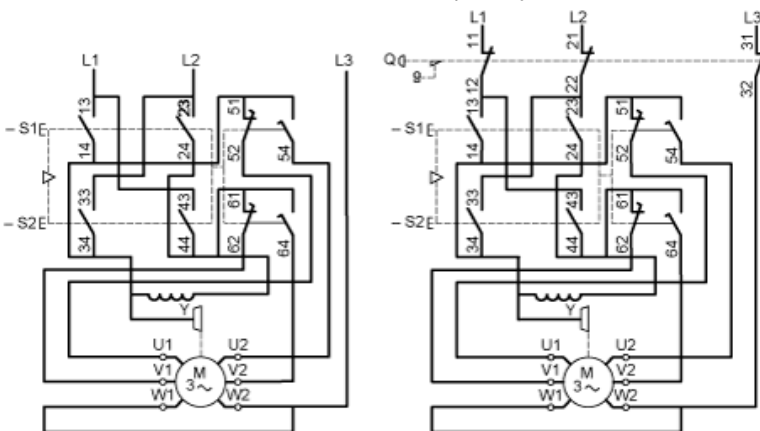

Control of Single-Speed Reversing Motor 3-Phase switching, Reversing by 2-Phase Inversion

With XESD2201 contact block, to be ordered separately

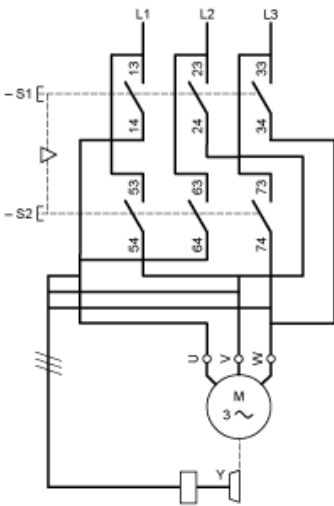

Control of Single-Speed Reversing Motor 3-Phase switching, Reversing by 2-Phase Inversion

With XESD2241 contact block, to be ordered separately

