

PLEASE CHECK WWW.MOLEX.COM FOR LATEST PART INFORMATION

Part Number: [52893-2495](#)
Status: **Active**
Overview: FFC-FPC (SMT)
Description: Easy-On™ Type FFC/FPC Connector, Right Angle, SMT, ZIF, Bottom Contact Style, 24 Circuits, Lead-Free

Documents:

[3D Model](#) [Packaging Specification SPK-52893-001 \(PDF\)](#)
[Drawing \(PDF\)](#) [RoHS Certificate of Compliance \(PDF\)](#)
[Product Specification PS-52892-038 \(PDF\)](#)

Agency Certification

UL E29179

General

Product Family	FFC/FPC Connectors
Series	52893
Comments	Hinge
Overview	FFC-FPC (SMT)
Product Name	Easy-On™
UPC	822348120932

Physical	
Circuits (Loaded)	24
Circuits (maximum)	24
Color - Resin	Natural
Contact Position	Bottom
Durability (mating cycles max)	20
Entry Angle	90° Angle
Flammability	94V-0
Mated Height	2.00mm
Material - Metal	Phosphor Bronze
Material - Plating Mating	Tin-Bismuth
Material - Plating Termination	Tin-Bismuth
Material - Resin	High Temperature Thermoplastic
Net Weight	257.600/mg
Number of Rows	1
Orientation	Right Angle
PCB Locator	No
PCB Retention	Yes
Packaging Type	Embossed Tape on Reel
Pitch - Mating Interface	0.50mm
Pitch - Termination Interface	0.50mm
Plating min - Mating	1.016µm
Plating min - Termination	1.016µm
Polarized to PCB	No
Stackable	No
Temperature Range - Operating	-20°C to +85°C
Termination Interface: Style	Surface Mount
Wire/Cable Type	FFC/FPC

Electrical

Current - Maximum per Contact 0.5A
Voltage - Maximum 50V

Material Info

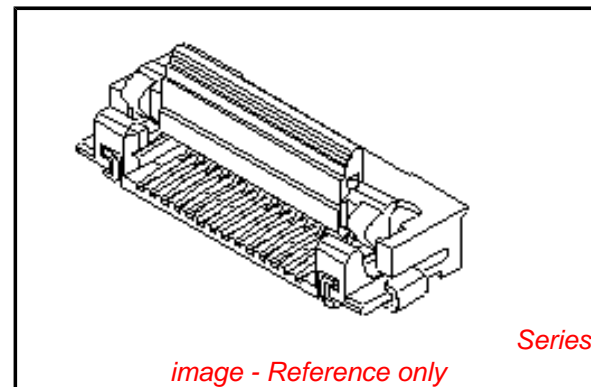

EU RoHS

ELV and RoHS Compliant
REACH SVHC Contains SVHC: No
Low-Halogen Status Not Low-Halogen

China RoHS



Need more information on product environmental compliance?

Email productcompliance@molex.com
For a multiple part number RoHS Certificate of Compliance, [click here](#)

Please visit the [Contact Us](#) section for any non-product compliance questions.

Search Parts in this Series

[52893Series](#)

Reference - Drawing Numbers

Packaging Specification

Product Specification

Sales Drawing

SPK-52893-001

PS-52892-038, RPS-52892-045, RPS-52892-052,

RPS-52892-055

SD-52893-040, SD-52893-041

This document was generated on 04/28/2014

PLEASE CHECK WWW.MOLEX.COM FOR LATEST PART INFORMATION