

Data sheet | Item number: 770-745

Snap-in socket; 5-pole; Cod. B; 4,00 mm<sup>2</sup>; gray

[www.wago.com/770-745](http://www.wago.com/770-745)

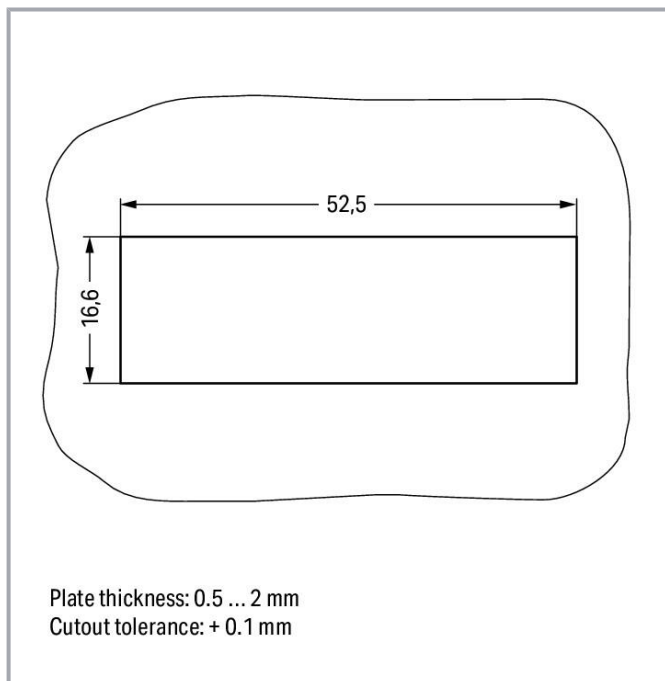
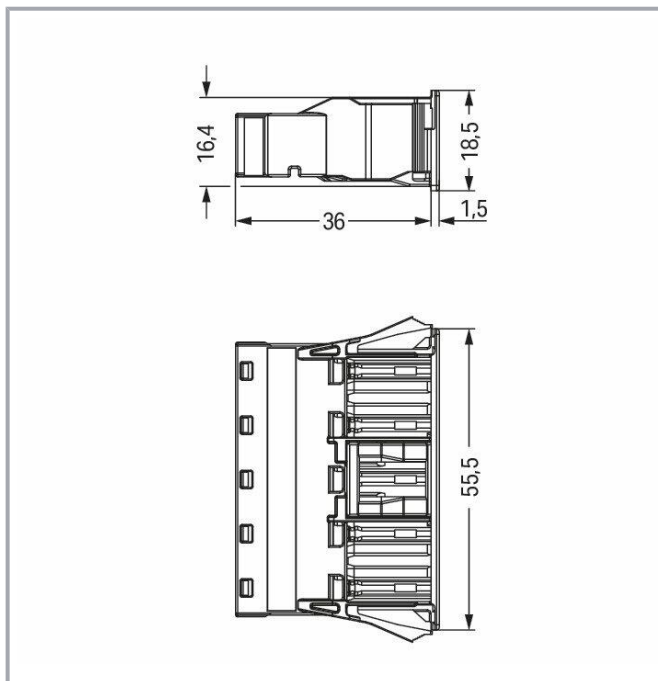
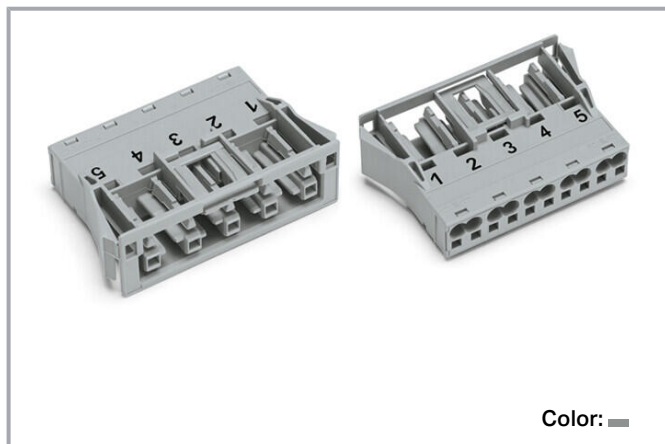

Subject to changes. Please also observe the further product documentation!

WAGO GmbH & Co. KG  
Hansastr. 27  
32423 Minden  
Phone: +49571 887-0 | Fax: +49571 887-169  
Email: [info.de@wago.com](mailto:info.de@wago.com) | Web: [www.wago.com](http://www.wago.com)

Do you have any questions about our products?  
We are always happy to take your call at +49 (571) 887-44222.



## Item description

### Female connector/socket WINSTA® MIDI with protection against mismatching

The WINSTA® MIDI female connector/socket 5-pole supports fast, reliable installation. Our pluggable installation connectors with spring pressure connection technology work entirely without screw connections. They allow flexible, error-free installation in a large number of possible uses. The mechanical coding and color coding of the pluggable installation connector ensure error-free installation of the individual components – including protection against mismatching. The pluggable installation connector is protected in accordance with protection type IP20 (When mated: IP2xC (These compact connectors are not designed for use in open, easily accessible areas!)). That results in the fact that users' fingers will never come into contact with electrified contact elements. B coding enables the WINSTA® MIDI pluggable installation connectors to be used for application control in the domains of automation, robotics, and mechanical engineering. The rated current and voltage are important criteria for selecting a pluggable installation connector: They tell us about the product's domains of use. This product has a current rating of 25 A – as a result it is suitable for powerful loads. WINSTA® MIDI with Push-in CAGE CLAMP® spring pressure connection technology is used in a broad range of individual products you can use for quick, easy and maximally flexible installation.

### WINSTA® MIDI solutions for your electrical installation – protected against mismatching and maintenance-free

The WINSTA® Pluggable Connection System allows pluggable electrical installation. This saves time, lowers costs, and reduces the need for servicing. Choose quality and durability – the WINSTA® MIDI pluggable installation connector with marking from WAGO makes the installation of electrical components visibly easier.

- 
- pluggable installation connectors with protection against mismatching
- pre-assembled versions
- with B coding for controllers such as sun blinds and lighting fixtures
- ready for immediate use
- quick replacement of defective units during ongoing operation

## Data

### Notes

Variants:

Other pole markings

Other versions (or variants) can be requested from WAGO Sales or configured at <https://configurator.wago.com/>.

## Electrical data

Subject to changes. Please also observe the further product documentation!

WAGO GmbH & Co. KG

Hansastr. 27

32423 Minden

Phone: +49571 887-0 | Fax: +49571 887-169

Email: [info.de@wago.com](mailto:info.de@wago.com) | Web: [www.wago.com](http://www.wago.com)

Do you have any questions about our products?

We are always happy to take your call at +49 (571) 887-44222.



## Ratings per IEC/EN

Ratings per	IEC/EN 60664-1
Nominal voltage (III/3)	400 V
Rated impulse voltage (III/3)	6 kV
Rated current	25 A
Note (rated current)	25 A for 3-pole load 20 A for 4- and 5-pole load
Legend (ratings)	(III / 3) $\hat{=}$ Overvoltage category III / Pollution degree 3

## Ratings per UL 1977

Note for the US market	Some versions may also be used for current interruption in accordance with the UL certificate in select applications with currents below 16 A and voltages up to 600 V. For further information, please contact your local sales office.
Rated voltage (UL 1977)	600 V
Rated current UL 1977	23 A

## General

Note on contact resistance	approx. 1 m $\Omega$ of contact resistance approx. 0.25 m $\Omega$ contact transition plug/socket
----------------------------	--

## Connection data

Connection points	10
Total number of potentials	5

## Connection 1

Connection technology	Push-in CAGE CLAMP <sup>®</sup>
Actuation type	Operating tool Push-in
Nominal cross-section	4 mm <sup>2</sup> / 12 AWG
Solid conductor	0.5 ... 4 mm <sup>2</sup> / 20 ... 12 AWG
Solid conductor; push-in termination	1.5 ... 4 mm <sup>2</sup> / 16 ... 12 AWG
Stranded conductor	0.5 ... 2.5 mm <sup>2</sup> / 20 ... 14 AWG
Fine-stranded conductor	0.5 ... 4 mm <sup>2</sup> / 20 ... 12 AWG
Fine-stranded conductor; with insulated ferrule	0.25 ... 1.5 mm <sup>2</sup> / 20 ... 16 AWG
Fine-stranded conductor; with uninsulated ferrule	0.25 ... 2.5 mm <sup>2</sup> / 20 ... 14 AWG

Subject to changes. Please also observe the further product documentation!



Fine-stranded conductor; with ferrule; push-in termination	1.5 mm <sup>2</sup> / 16 AWG
Strip length	9 mm / 0.35 inches
Pole number	5
Conductor entry direction to mating direction	0°

### Physical data

Pin spacing	10 mm / 0.394 inches
Width	55.5 mm / 2.185 inches
Height	18.5 mm / 0.728 inches
Depth	37.5 mm / 1.476 inches

### Mechanical Data

Application	Control technology
Coding	B
Variable coding	Yes
Marking	1 2 3 4 5
Potential marking	1 2 3 4 5
Mating force of a plug-in connection	approx. 20 ... 70 N (depending on pole number)
Retention force of a plug-in connection	Locked: > 80 N
Unmating force of a plug-in connection	Unlocked: approx. 20 ... 70 N (depending on pole number)
Number of mating cycles	200, without resistive load
Housing sheet thickness	0.5 ... 2 mm / 0.02 ... 0.079 inches
Mounting type	Snap-in flange
Protection type	IP20; When mated: IP2xC (These compact connectors are not designed for use in open, easily accessible areas!)

### Plug-in connection

Contact type (pluggable connector)	Female connector/socket
Connector (connection type)	for conductor
Mismating protection	Yes
Note on mismating protection	All <b>WINSTA</b> <sup>®</sup> components are 100% protected against mismating when: a.) plugging different numbers of poles b.) plugging while rotated 180 c.) plugging while laterally staggered d.) plugging one pole
Locking lever	yes
Locking of plug-in connection	locking lever

Subject to changes. Please also observe the further product documentation!



## Note on locking system

All connectors for mounted installations (snap-in versions for lighting fixtures or devices, all types of PCB and distribution connectors) are factory-equipped with locking levers to ensure plugs and sockets are securely locked. Additional locking levers are only required for flying leads (plug/socket).

## Material Data

## Note (material data)

Information on material specifications can be found here

Color	gray
Insulation material	Polyamide (PA66)
Flammability class per UL94	V0
Clamping spring material	Chrome-nickel spring steel (CrNi)
Contact material	Copper or copper alloy; surface-treated
Contact plating	Tin
Fire load	0.481 MJ
Weight	19 g

## Environmental requirements

Processing temperature	-5 ... +40 °C
Continuous operating temperature	-35 ... +85 °C
Note on continuous operating temperature	Insulating parts for temperatures $\leq$ 105 °C

## Commercial data

eCl@ss 10.0	27-44-06-02
eCl@ss 9.0	27-44-06-02
ETIM 8.0	EC002566
ETIM 7.0	EC002566
PU (SPU)	50 pcs
Packaging type	box
Country of origin	DE
GTIN	4055143594189
Customs tariff number	85366990990



## Environmental Product Compliance

RoHS Compliance Status	Compliant, No Exemption
------------------------	-------------------------



Subject to changes. Please also observe the further product documentation!

## Approvals / Certificates



### General approvals

Logo	Approval	Additional Approval Text	Certificate name
	CCA DEKRA Certification B.V.	EN 61984	2173495.01
	CCA DEKRA Certification B.V.	IEC 61984	NL-32104
	cURus Underwriters Laboratories Inc.	UL 1977	E45171

### Declarations of conformity and manufacturer's declarations

Logo	Approval	Additional Approval Text	Certificate name
	EU-Declaration of Conformity WAGO GmbH & Co. KG	-	-
	UK-Declaration of Conformity WAGO GmbH & Co. KG	-	-

### Approvals for marine applications



Logo	Approval	Additional Approval Text	Certificate name
	ABS American Bureau of Shipping	-	19- HG1868589- PDA
	DNV GL Det Norske Veritas, Germanischer Lloyd	-	TAE00001Z6
	LR Lloyds Register	IEC 61984	LR22429487TA

Subject to changes. Please also observe the further product documentation!

WAGO GmbH & Co. KG  
Hansastr. 27  
32423 Minden  
Phone: +49571 887-0 | Fax: +49571 887-169  
Email: [info.de@wago.com](mailto:info.de@wago.com) | Web: [www.wago.com](http://www.wago.com)

Do you have any questions about our products?  
We are always happy to take your call at +49 (571) 887-44222.





## Counterpart

	<b>Item no.770-255</b> Plug; 5-pole; Cod. B; 4,00 mm <sup>2</sup> ; gray	<a href="http://www.wago.com/770-255">www.wago.com/770-255</a>
	<b>Item no.771-9995/005-103</b> pre-assembled interconnecting cable; Eca; Socket/plug; 5-pole; Cod. B; 1 m; 1,00 mm <sup>2</sup> ; gray	<a href="http://www.wago.com/771-9995/005-103">www.wago.com/771-9995/005-103</a>
	<b>Item no.771-9995/205-103</b> pre-assembled connecting cable; Eca; Plug/open-ended; 5-pole; Cod. B; 1 m; 1,00 mm <sup>2</sup> ; gray	<a href="http://www.wago.com/771-9995/205-103">www.wago.com/771-9995/205-103</a>

## Optional accessories

### Cover

#### Cover

	<b>Item no.: 770-695</b> Lockout cap; 5-pole; for cutouts; Plastic; white	<a href="http://www.wago.com/770-695">www.wago.com/770-695</a>
	<b>Item no.: 770-645</b> Lockout cap; 5-pole; for cutouts; Plastic; black	<a href="http://www.wago.com/770-645">www.wago.com/770-645</a>
	<b>Item no.: 770-201</b> Lockout cap; 12-pole, separable; for sockets; Plastic; black	<a href="http://www.wago.com/770-201">www.wago.com/770-201</a>
	<b>Item no.: 770-221</b> Lockout cap; 12-pole, separable; for sockets; Plastic; white	<a href="http://www.wago.com/770-221">www.wago.com/770-221</a>

### Tool

#### Operating tool

	<b>Item no.: 210-719</b> Operating tool; Blade: 2.5 x 0.4 mm; with a partially insulated shaft	<a href="http://www.wago.com/210-719">www.wago.com/210-719</a>
--	---	--

## Downloads

### Documentation

#### Bid Text

770-745 X81 - Datei	2019 Feb 19	xml 3.0 kB	Download
770-745 doc - Datei	2015 Jun 8	doc 24.6 kB	Download

Subject to changes. Please also observe the further product documentation!

## CAD/CAE-Data

### CAD data

2D/3D Models 770-745	URL	Download
----------------------	-----	----------

### CAE data

EPLAN Data Portal 770-745	URL	Download
---------------------------	-----	----------

WSCAD Universe 770-745	URL	Download
------------------------	-----	----------

ZUKEN Portal 770-745	URL	Download
----------------------	-----	----------

## Environmental Product Compliance

### Compliance Search

Environmental Product Compliance 770-745	URL	Download
--	-----	----------

Snap-in socket; 5-pole; Cod. B; 4,00 mm<sup>2</sup>; gray

## Installation Notes

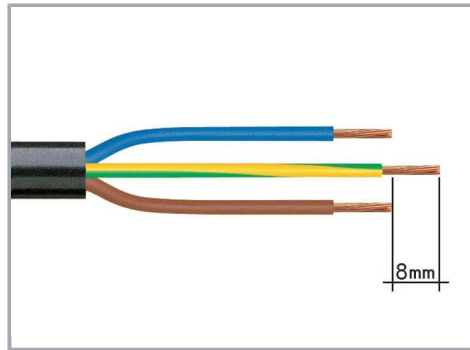
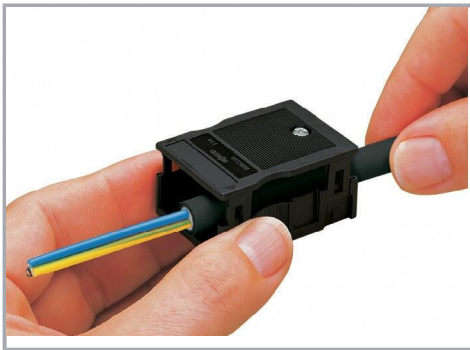

We recommend pulling the pre-latched strain relief housing over the cable prior to termination. However, the strain relief can be mounted at a later time as well.

1. Strip length, outer insulation = 35 mm (2-pole), 55 mm (3- to 5-pole)
2. Strip length = 9 mm
3. Extended ground conductor = 8 mm

Subject to changes. Please also observe the further product documentation!



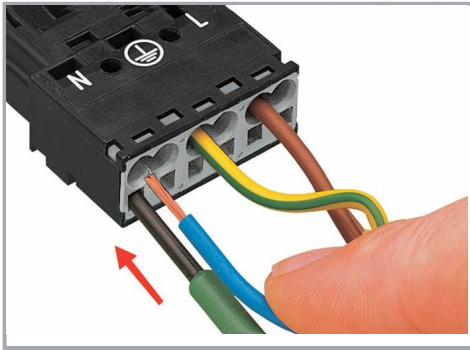

To terminate fine-stranded conductors, open the clamping unit via screwdriver (2.5 mm blade width) and insert a stripped conductor until it hits the backstop.

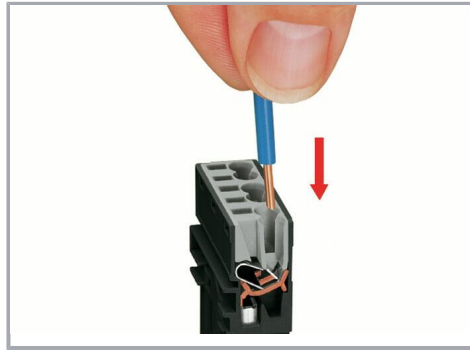

Insert the stripped solid conductor until it hits the backstop.

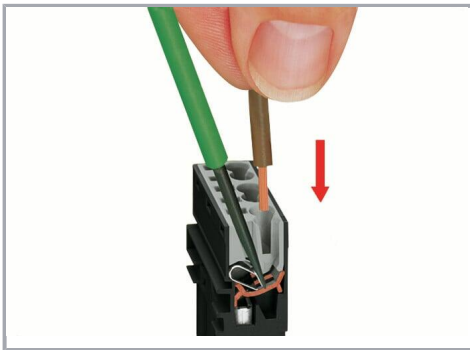

To terminate fine-stranded conductors, open the clamping unit via screwdriver (2.5 mm blade width) and insert a stripped conductor until it hits the backstop.

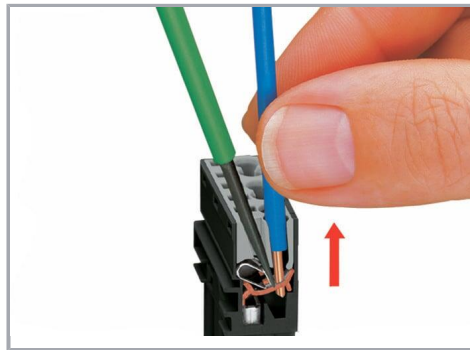

To remove the conductor, actuate the clamp via screwdriver (2.5 mm blade width) and pull out the conductor.

## Product family

**WINSTA® MIDI**

[Show all products from the family](#)

Subject to changes. Please also observe the further product documentation!