

# NCP134

## 500 mA, Very Low Dropout Bias Rail CMOS Voltage Regulator

The NCP134 is a 500 mA VLDO equipped with NMOS pass transistor and a separate bias supply voltage ( $V_{BIAS}$ ). The device provides very stable, accurate output voltage with low noise suitable for space constrained, noise sensitive applications. In order to optimize performance for battery operated portable applications, the NCP134 features low  $I_Q$  consumption. The XDFN4 1.2 mm x 1.2 mm package is optimized for use in space constrained applications.

### Features

- Input Voltage Range: 0.8 V to 5.5 V
- Bias Voltage Range: 2.4 V to 5.5 V
- Fixed Voltage Versions Available
- Output Voltage Range: 0.8 V to 2.1 V (Fixed)
- $\pm 1.5\%$  Accuracy over Temperature, 0.5%  $V_{OUT}$  @ 25°C
- Ultra-Low Dropout: Max. 150 mV at 500 mA, 1.1 V Output, 3.3 V Bias, 85°C
- Very Low Bias Input Current of Typ. 80  $\mu$ A
- Very Low Bias Input Current in Disable Mode: Typ. 0.5  $\mu$ A
- Logic Level Enable Input for ON/OFF Control
- Output Active Discharge Option Available
- Stable with a 2.2  $\mu$ F Ceramic Capacitor
- Available in XDFN4 – 1.2 mm x 1.2 mm x 0.4 mm Package
- These Devices are Pb-Free, Halogen Free/BFR Free and are RoHS Compliant

### Typical Applications

- Battery-powered Equipment
- Smartphones, Tablets
- Cameras, DVRs, STB and Camcorders

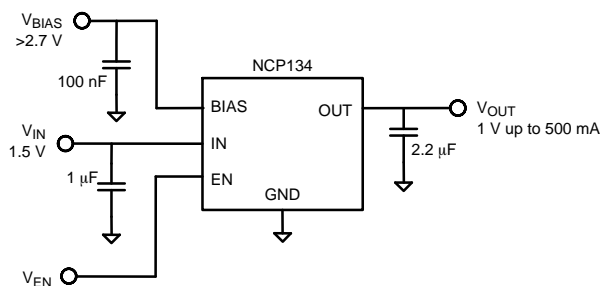

Figure 1. Typical Application Schematics



ON Semiconductor™

[www.onsemi.com](http://www.onsemi.com)



XDFN4  
CASE 711BC

### MARKING DIAGRAM



XX = Specific Device Code  
M = Date Code

### PIN CONNECTIONS

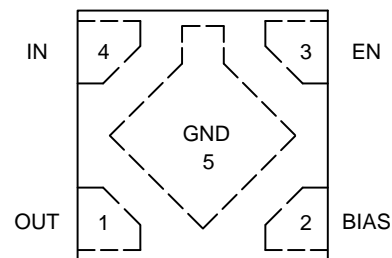

(Top View)

### ORDERING INFORMATION

See detailed ordering, marking and shipping information on page 10 of this data sheet.

# NCP134

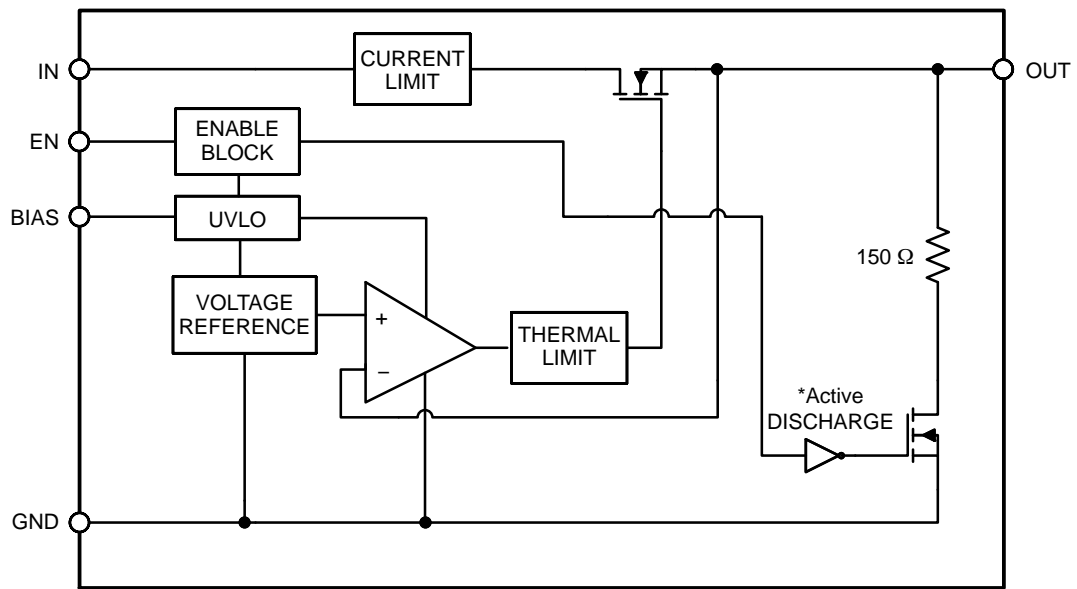

\*Active output discharge function is present only in NCP134AMXyyyTCG devices.  
yyy denotes the particular output voltage option.

**Figure 2. Simplified Schematic Block Diagram – Fixed Version**

# NCP134

## PIN FUNCTION DESCRIPTION

Pin No. XDFN4	Pin Name	Description
1	OUT	Regulated Output Voltage pin
2	BIAS	Bias voltage supply for internal control circuits. This pin is monitored by internal Under-Voltage Lockout Circuit.
3	EN	Enable pin. Driving this pin high enables the regulator. Driving this pin low puts the regulator into shutdown mode.
4	IN	Input Voltage Supply pin
5	GND	Ground

## ABSOLUTE MAXIMUM RATINGS

Rating	Symbol	Value	Unit
Input Voltage (Note 1)	$V_{IN}$	-0.3 to 6	V
Output Voltage	$V_{OUT}$	$-0.3 \text{ to } (V_{IN}+0.3) \leq 6$	V
Chip Enable, Bias Input	$V_{EN}, V_{BIAS}$	-0.3 to 6	V
Output Short Circuit Duration	$t_{SC}$	unlimited	s
Maximum Junction Temperature	$T_J$	150	°C
Storage Temperature	$T_{STG}$	-55 to 150	°C
ESD Capability, Human Body Model (Note 2)	$ESD_{HBM}$	2000	V
ESD Capability, Machine Model (Note 2)	$ESD_{MM}$	200	V

Stresses exceeding those listed in the Maximum Ratings table may damage the device. If any of these limits are exceeded, device functionality should not be assumed, damage may occur and reliability may be affected.

1. Refer to ELECTRICAL CHARACTERISTICS and APPLICATION INFORMATION for Safe Operating Area.
2. This device series incorporates ESD protection (except OUT pin) and is tested by the following methods:  
 ESD Human Body Model tested per EIA/JESD22-A114  
 ESD Machine Model tested per EIA/JESD22-A115  
 Latchup Current Maximum Rating tested per JEDEC standard: JESD78.

## THERMAL CHARACTERISTICS

Rating	Symbol	Value	Unit
Thermal Characteristics, XDFN4 1.2 mm x 1.2 mm Thermal Resistance, Junction-to-Air (Note 3)	$R_{\theta JA}$	170	°C/W

3. This data was derived by thermal simulations for a single device mounted on the 40 mm x 40 mm x 1.6 mm FR4 PCB with 2-ounce 800 sq mm copper area on top and bottom.

# NCP134

**ELECTRICAL CHARACTERISTICS**  $-40^{\circ}\text{C} \leq T_J \leq 85^{\circ}\text{C}$ ;  $V_{\text{BIAS}} = 2.7\text{ V}$  or  $(V_{\text{OUT}} + 1.6\text{ V})$ , whichever is greater,  $V_{\text{IN}} = V_{\text{OUT(NOM)}} + 0.3\text{ V}$ ,  $I_{\text{OUT}} = 1\text{ mA}$ ,  $V_{\text{EN}} = 1\text{ V}$ , unless otherwise noted.  $C_{\text{IN}} = 1\text{ }\mu\text{F}$ ,  $C_{\text{OUT}} = 2.2\text{ }\mu\text{F}$ . Typical values are at  $T_J = +25^{\circ}\text{C}$ . Min/Max values are for  $-40^{\circ}\text{C} \leq T_J \leq 85^{\circ}\text{C}$  unless otherwise noted. (Note 4)

Parameter	Test Conditions	Symbol	Min	Typ	Max	Unit
Operating Input Voltage Range		$V_{\text{IN}}$	$V_{\text{OUT}} + V_{\text{DO}}$		5.5	V
Operating Bias Voltage Range		$V_{\text{BIAS}}$	$(V_{\text{OUT}} + 1.40) \geq 2.4$		5.5	V
Undervoltage Lock-out	$V_{\text{BIAS}}$ Rising Hysteresis	UVLO		1.6 0.2		V
Output Voltage Accuracy		$V_{\text{OUT}}$		$\pm 0.5$		%
Output Voltage Accuracy	$-40^{\circ}\text{C} \leq T_J \leq 85^{\circ}\text{C}$ , $V_{\text{OUT(NOM)}} + 0.3\text{ V} \leq V_{\text{IN}} \leq V_{\text{OUT(NOM)}} + 1.0\text{ V}$ , $2.7\text{ V}$ or $(V_{\text{OUT(NOM)}} + 1.6\text{ V})$ , whichever is greater $< V_{\text{BIAS}} < 5.5\text{ V}$ , $1\text{ mA} < I_{\text{OUT}} < 500\text{ mA}$	$V_{\text{OUT}}$	-1.5		+1.5	%
$V_{\text{IN}}$ Line Regulation	$V_{\text{OUT(NOM)}} + 0.3\text{ V} \leq V_{\text{IN}} \leq 5.0\text{ V}$	LineReg		0.01		%/V
$V_{\text{BIAS}}$ Line Regulation	$2.7\text{ V}$ or $(V_{\text{OUT(NOM)}} + 1.6\text{ V})$ , whichever is greater $< V_{\text{BIAS}} < 5.5\text{ V}$	LineReg		0.01		%/V
Load Regulation	$I_{\text{OUT}} = 1\text{ mA}$ to $500\text{ mA}$	LoadReg		1.5		mV
$V_{\text{IN}}$ Dropout Voltage	$I_{\text{OUT}} = 150\text{ mA}$ (Note 5)	$V_{\text{DO}}$		37	75	mV
	$I_{\text{OUT}} = 500\text{ mA}$ (Note 5)	$V_{\text{DO}}$		140	250	
$V_{\text{IN}}$ Dropout Voltage	NCP134AMX110TCG device, $V_{\text{OUT(NOM)}} = 1.1\text{ V}$ , $V_{\text{BIAS}} = 3.3\text{ V}$ , $I_{\text{OUT}} = 500\text{ mA}$ (Note 5)	$V_{\text{DO}}$		100	150	
$V_{\text{BIAS}}$ Dropout Voltage	$I_{\text{OUT}} = 500\text{ mA}$ , $V_{\text{IN}} = V_{\text{BIAS}}$ (Notes 5, 6)	$V_{\text{DO}}$		1.1	1.5	V
Output Current Limit	$V_{\text{OUT}} = 90\% V_{\text{OUT(NOM)}}$	$I_{\text{CL}}$	550	800	1000	mA
Bias Pin Operating Current	$V_{\text{BIAS}} = 2.7\text{ V}$	$I_{\text{BIAS}}$		80	110	$\mu\text{A}$
Bias Pin Disable Current	$V_{\text{EN}} \leq 0.4\text{ V}$	$I_{\text{BIAS(DIS)}}$		0.5	1	$\mu\text{A}$
Vinpin Pin Disable Current	$V_{\text{EN}} \leq 0.4\text{ V}$	$I_{\text{VIN(DIS)}}$		0.5	1	$\mu\text{A}$
EN Pin Threshold Voltage	EN Input Voltage "H"	$V_{\text{EN(H)}}$	0.9			V
	EN Input Voltage "L"	$V_{\text{EN(L)}}$			0.4	
EN Pull Down Current	$V_{\text{EN}} = 5.5\text{ V}$	$I_{\text{EN}}$		0.3	1	$\mu\text{A}$
Turn-On Time	From assertion of $V_{\text{EN}}$ to $V_{\text{OUT}} = 98\% V_{\text{OUT(NOM)}}$ . $V_{\text{OUT(NOM)}} = 1.0\text{ V}$	$t_{\text{ON}}$		150		$\mu\text{s}$
Power Supply Rejection Ratio	$V_{\text{IN}}$ to $V_{\text{OUT}}$ , $f = 1\text{ kHz}$ , $I_{\text{OUT}} = 150\text{ mA}$ , $V_{\text{IN}} \geq V_{\text{OUT}} + 0.5\text{ V}$	PSRR( $V_{\text{IN}}$ )		70		dB
	$V_{\text{BIAS}}$ to $V_{\text{OUT}}$ , $f = 1\text{ kHz}$ , $I_{\text{OUT}} = 150\text{ mA}$ , $V_{\text{IN}} \geq V_{\text{OUT}} + 0.5\text{ V}$	PSRR( $V_{\text{BIAS}}$ )		80		
Output Noise Voltage	$V_{\text{IN}} = V_{\text{OUT}} + 0.5\text{ V}$ , $V_{\text{OUT(NOM)}} = 1\text{ V}$ , $f = 10\text{ Hz}$ to $100\text{ kHz}$	$V_{\text{N}}$		40		$\mu\text{V}_{\text{RMS}}$
Thermal Shutdown Threshold	Temperature increasing			160		$^{\circ}\text{C}$
	Temperature decreasing			140		
Output Discharge Pull-Down	$V_{\text{EN}} \leq 0.4\text{ V}$ , $V_{\text{OUT}} = 0.5\text{ V}$ , NCP134A options only	$R_{\text{DISCH}}$		150		$\Omega$

Product parametric performance is indicated in the Electrical Characteristics for the listed test conditions, unless otherwise noted. Product performance may not be indicated by the Electrical Characteristics if operated under different conditions.

4. Performance guaranteed over the indicated operating temperature range by design and/or characterization. Production tested at  $T_A = 25^{\circ}\text{C}$ . Low duty cycle pulse techniques are used during the testing to maintain the junction temperature as close to ambient as possible.
5. Dropout voltage is characterized when  $V_{\text{OUT}}$  falls 3% below  $V_{\text{OUT(NOM)}}$ .
6. For output voltages below  $0.9\text{ V}$ ,  $V_{\text{BIAS}}$  dropout voltage does not apply due to a minimum Bias operating voltage of  $2.4\text{ V}$ .

TYPICAL CHARACTERISTICS

At  $T_J = +25^\circ\text{C}$ ,  $V_{IN} = V_{OUT(TYP)} + 0.3\text{ V}$ ,  $V_{BIAS} = 2.7\text{ V}$ ,  $V_{EN} = V_{BIAS}$ ,  $V_{OUT(NOM)} = 1.0\text{ V}$ ,  $I_{OUT} = 500\text{ mA}$ ,  $C_{IN} = 1\text{ }\mu\text{F}$ ,  $C_{BIAS} = 0.1\text{ }\mu\text{F}$ , and  $C_{OUT} = 2.2\text{ }\mu\text{F}$  (effective capacitance), unless otherwise noted.

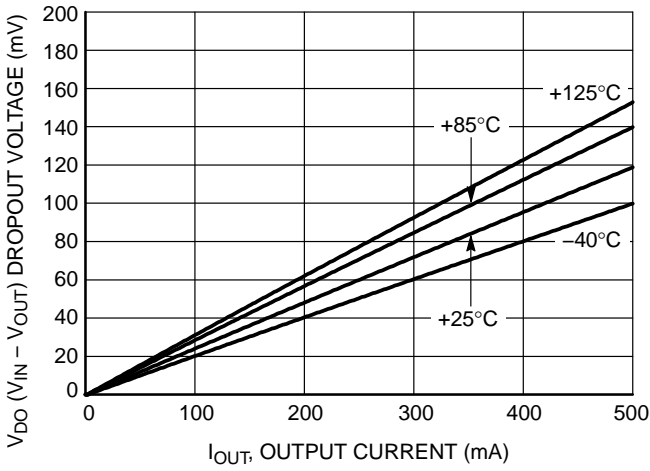

Figure 3.  $V_{IN}$  Dropout Voltage vs.  $I_{OUT}$  and Temperature  $T_J$

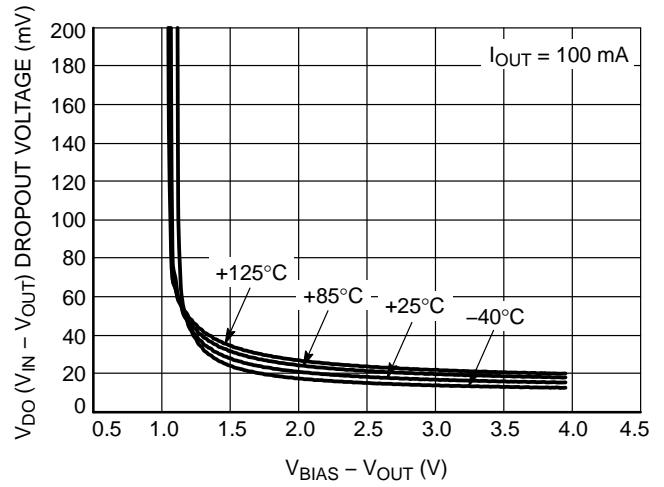

Figure 4.  $V_{IN}$  Dropout Voltage vs.  $(V_{BIAS} - V_{OUT})$  and Temperature  $T_J$

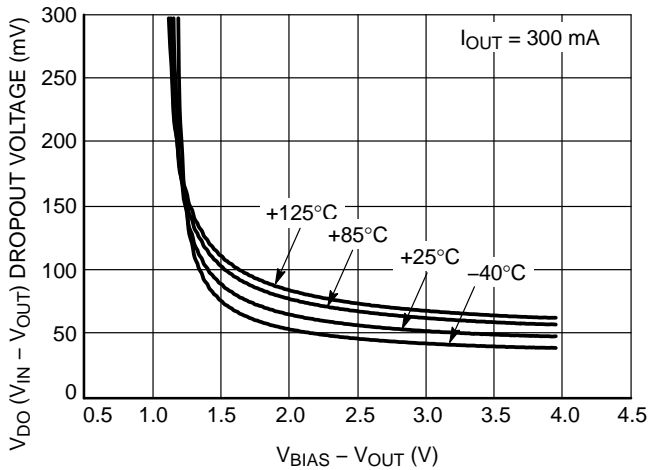

Figure 5.  $V_{IN}$  Dropout Voltage vs.  $(V_{BIAS} - V_{OUT})$  and Temperature  $T_J$

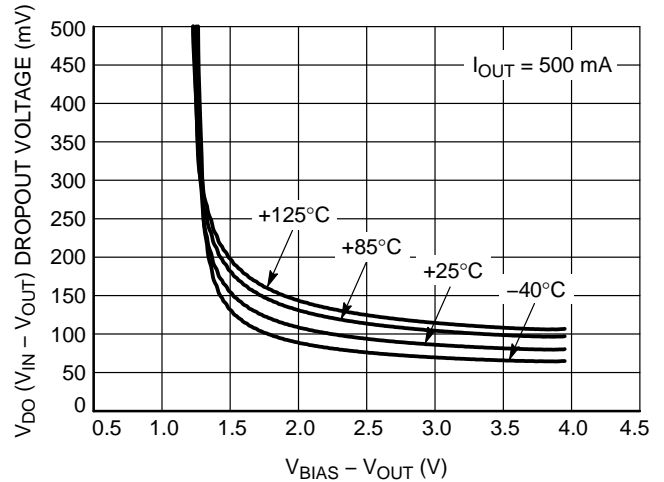

Figure 6.  $V_{IN}$  Dropout Voltage vs.  $(V_{BIAS} - V_{OUT})$  and Temperature  $T_J$

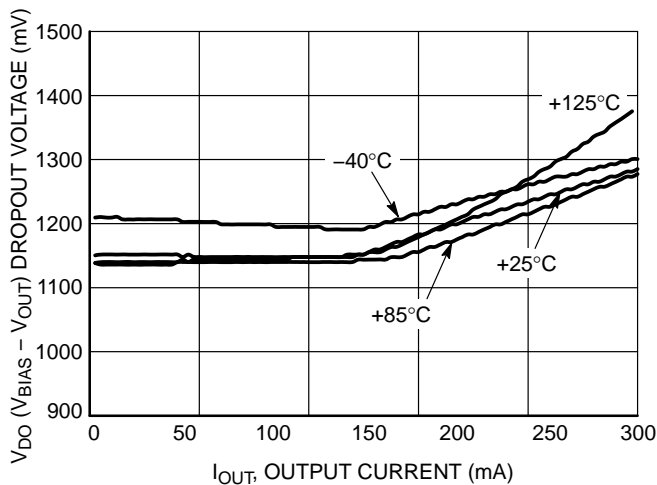

Figure 7.  $V_{BIAS}$  Dropout Voltage vs.  $I_{OUT}$  and Temperature  $T_J$

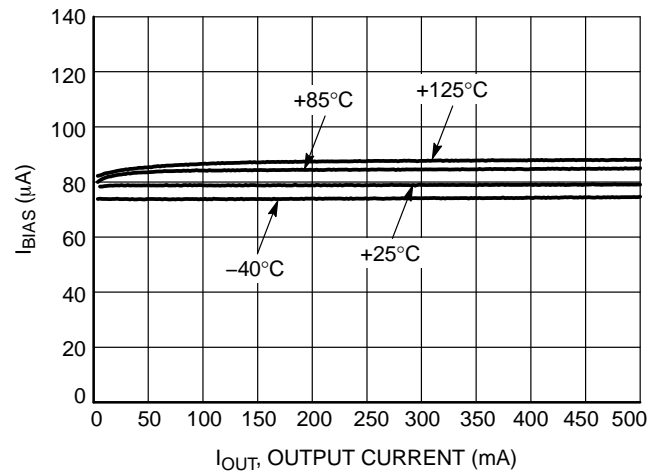

Figure 8. BIAS Pin Current vs.  $I_{OUT}$  and Temperature  $T_J$

# NCP134

## TYPICAL CHARACTERISTICS

At  $T_J = +25^\circ\text{C}$ ,  $V_{IN} = V_{OUT(TYP)} + 0.3\text{ V}$ ,  $V_{BIAS} = 2.7\text{ V}$ ,  $V_{EN} = V_{BIAS}$ ,  $V_{OUT(NOM)} = 1.0\text{ V}$ ,  $I_{OUT} = 500\text{ mA}$ ,  
 $C_{IN} = 1\text{ }\mu\text{F}$ ,  $C_{BIAS} = 0.1\text{ }\mu\text{F}$ , and  $C_{OUT} = 2.2\text{ }\mu\text{F}$  (effective capacitance), unless otherwise noted.

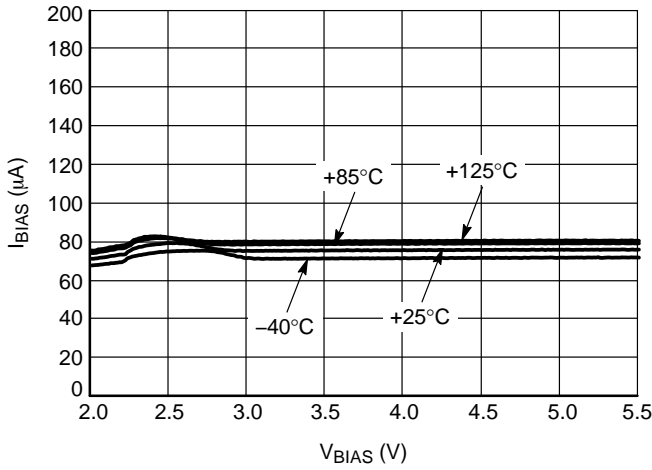

Figure 9. BIAS Pin Current vs.  $V_{BIAS}$  and Temperature  $T_J$

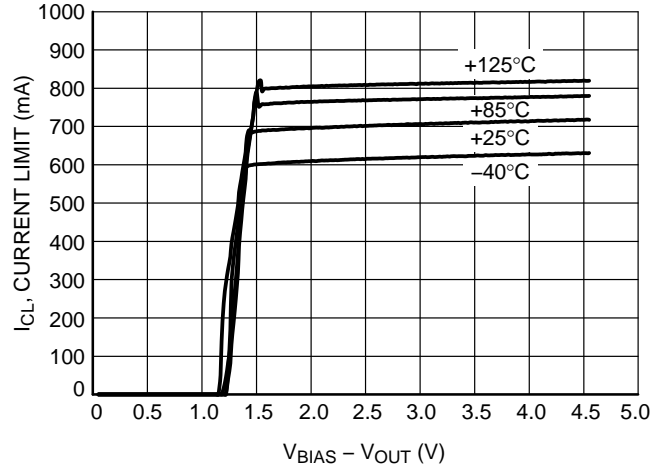

Figure 10. Current Limit vs.  $(V_{BIAS} - V_{OUT})$

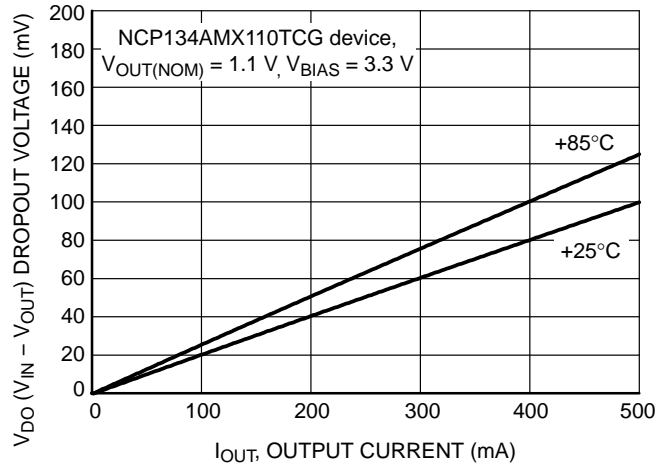
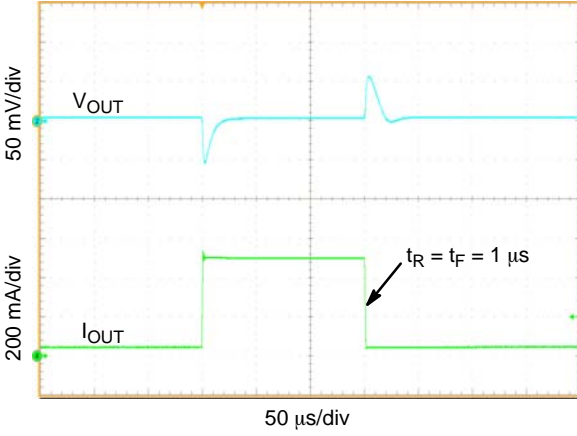

Figure 11.  $V_{IN}$  Dropout Voltage vs.  $I_{OUT}$  and Temperature  $T_J$

# NCP134

## TYPICAL CHARACTERISTICS

At  $T_J = +25^\circ\text{C}$ ,  $V_{IN} = V_{OUT(TYP)} + 0.3\text{ V}$ ,  $V_{BIAS} = 2.7\text{ V}$ ,  $V_{EN} = V_{BIAS}$ ,  $V_{OUT(NOM)} = 1.0\text{ V}$ ,  $I_{OUT} = 500\text{ mA}$ ,  $C_{IN} = 1\text{ }\mu\text{F}$ ,  $C_{BIAS} = 0.1\text{ }\mu\text{F}$ , and  $C_{OUT} = 2.2\text{ }\mu\text{F}$  (effective capacitance), unless otherwise noted.



**Figure 12. Load Transient Response,  $I_{OUT} = 50\text{ mA}$  to  $500\text{ mA}$ ,  $C_{OUT} = 10\text{ }\mu\text{F}$**

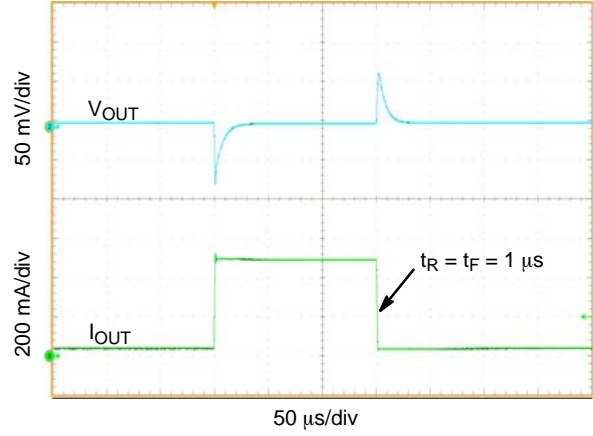

**Figure 13. Load Transient Response,  $I_{OUT} = 50\text{ mA}$  to  $500\text{ mA}$ ,  $C_{OUT} = 2.2\text{ }\mu\text{F}$**

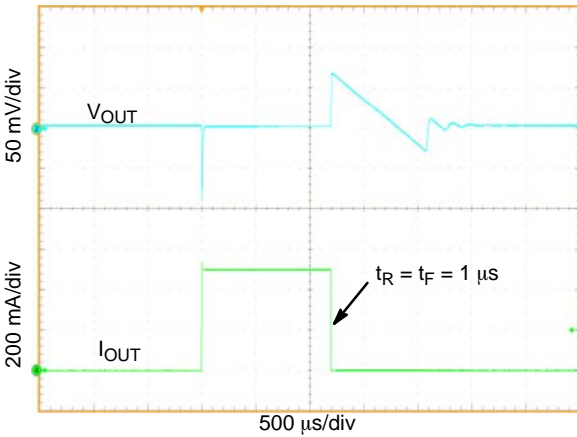

**Figure 14. Load Transient Response,  $I_{OUT} = 1\text{ mA}$  to  $500\text{ mA}$ ,  $C_{OUT} = 10\text{ }\mu\text{F}$**

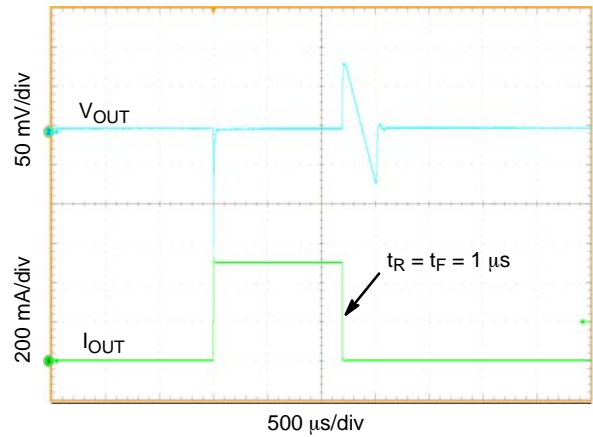

**Figure 15. Load Transient Response,  $I_{OUT} = 1\text{ mA}$  to  $500\text{ mA}$ ,  $C_{OUT} = 2.2\text{ }\mu\text{F}$**

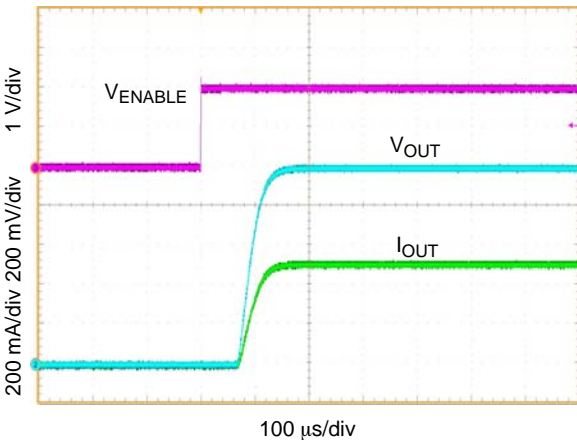

**Figure 16. Enable Turn-on Response, Output Resistive Load  $500\text{ mA}$ ,  $C_{OUT} = 10\text{ }\mu\text{F}$**

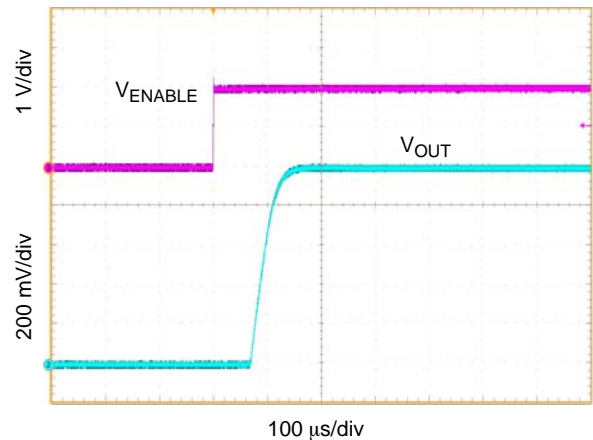
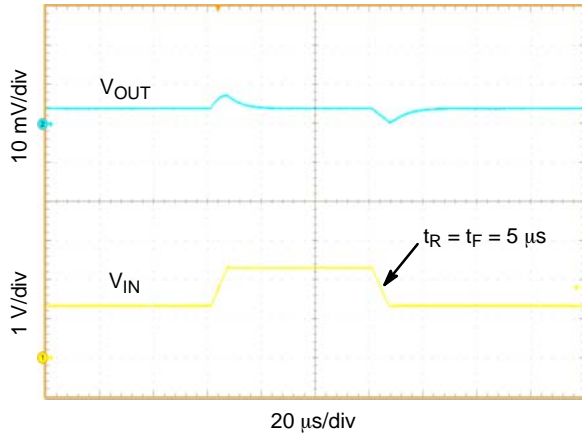

**Figure 17. Enable Turn-on Response,  $I_{OUT} = 0\text{ mA}$ ,  $C_{OUT} = 2.2\text{ }\mu\text{F}$**

# NCP134

## TYPICAL CHARACTERISTICS

At  $T_J = +25^\circ\text{C}$ ,  $V_{IN} = V_{OUT(TYP)} + 0.3\text{ V}$ ,  $V_{BIAS} = 2.7\text{ V}$ ,  $V_{EN} = V_{BIAS}$ ,  $V_{OUT(NOM)} = 1.0\text{ V}$ ,  $I_{OUT} = 500\text{ mA}$ ,  
 $C_{IN} = 1\text{ }\mu\text{F}$ ,  $C_{BIAS} = 0.1\text{ }\mu\text{F}$ , and  $C_{OUT} = 2.2\text{ }\mu\text{F}$  (effective capacitance), unless otherwise noted.



**Figure 18.  $V_{IN}$  Line Transient Response,**  
 $V_{IN} = 1.3\text{ V to } 2.3\text{ V}$ ,  $I_{OUT} = 100\text{ mA}$ ,  $C_{OUT} = 10\text{ }\mu\text{F}$

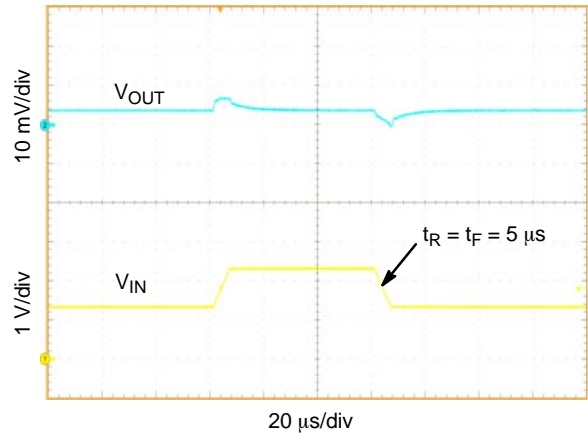

**Figure 19.  $V_{IN}$  Line Transient Response,**  
 $V_{IN} = 1.3\text{ V to } 2.3\text{ V}$ ,  $I_{OUT} = 100\text{ mA}$ ,  $C_{OUT} = 2.2\text{ }\mu\text{F}$



APPLICATIONS INFORMATION

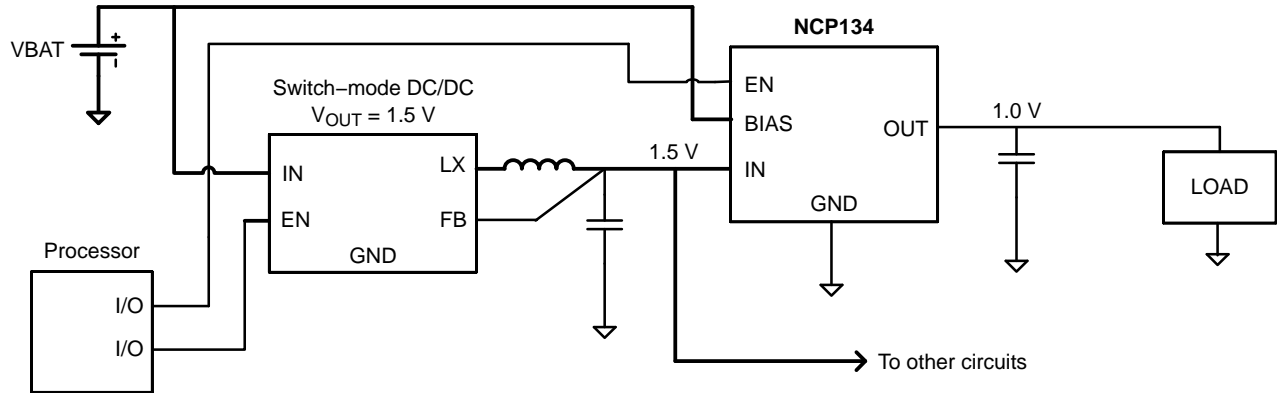

Figure 20. Typical Application: Low-Voltage DC/DC Post-Regulator with ON/OFF Functionality

The NCP134 dual-rail very low dropout voltage regulator is using NMOS pass transistor for output voltage regulation from  $V_{IN}$  voltage. All the low current internal control circuitry is powered from the  $V_{BIAS}$  voltage.

The use of an NMOS pass transistor offers several advantages in applications. Unlike PMOS topology devices, the output capacitor has reduced impact on loop stability.  $V_{in}$  to  $V_{out}$  operating voltage difference can be very low compared with standard PMOS regulators in very low  $V_{in}$  applications.

The NCP134 offers smooth monotonic start-up. The controlled voltage rising limits the inrush current.

The Enable (EN) input is equipped with internal hysteresis. NCP134 Voltage linear regulator Fixed version is available.

**Dropout Voltage**

Because of two power supply inputs  $V_{IN}$  and  $V_{BIAS}$  and one  $V_{OUT}$  regulator output, there are two Dropout voltages specified.

The first, the  $V_{IN}$  Dropout voltage is the voltage difference ( $V_{IN} - V_{OUT}$ ) when  $V_{OUT}$  starts to decrease by percent specified in the Electrical Characteristics table.  $V_{BIAS}$  is high enough; specific value is published in the Electrical Characteristics table.

The second,  $V_{BIAS}$  dropout voltage is the voltage difference ( $V_{BIAS} - V_{OUT}$ ) when  $V_{IN}$  and  $V_{BIAS}$  pins are joined together and  $V_{OUT}$  starts to decrease.

**Input and Output Capacitors**

The device is designed to be stable for ceramic output capacitors with Effective capacitance in the range from 2.2  $\mu\text{F}$  to 10  $\mu\text{F}$ . The device is also stable with multiple capacitors in parallel, having the total effective capacitance in the specified range.

In applications where no low input supplies impedance available (PCB inductance in  $V_{IN}$  and/or  $V_{BIAS}$  inputs as example), the recommended  $C_{IN} = 1 \mu\text{F}$  and  $C_{BIAS} = 0.1 \mu\text{F}$

or greater. Ceramic capacitors are recommended. For the best performance all the capacitors should be connected to the NCP134 respective pins directly in the device PCB copper layer, not through vias having not negligible impedance.

When using small ceramic capacitor, their capacitance is not constant but varies with applied DC biasing voltage, temperature and tolerance. The effective capacitance can be much lower than their nominal capacitance value, most importantly in negative temperatures and higher LDO output voltages. That is why the recommended Output capacitor capacitance value is specified as Effective value in the specific application conditions.

**Enable Operation**

The enable pin will turn the regulator on or off. The threshold limits are covered in the electrical characteristics table in this data sheet. If the enable function is not to be used then the pin should be connected to  $V_{IN}$  or  $V_{BIAS}$ .

**Current Limitation**

The internal Current Limitation circuitry allows the device to supply the full nominal current and surges but protects the device against Current Overload or Short.

**Thermal Protection**

Internal thermal shutdown (TSD) circuitry is provided to protect the integrated circuit in the event that the maximum junction temperature is exceeded. When TSD activated, the regulator output turns off. When cooling down under the low temperature threshold, device output is activated again. This TSD feature is provided to prevent failures from accidental overheating.

Activation of the thermal protection circuit indicates excessive power dissipation or inadequate heatsinking. For reliable operation, junction temperature should be limited to +125°C maximum.

# NCP134

## ORDERING INFORMATION

Device	Nominal Output Voltage	Marking	Option	Package	Shipping†
NCP134AMX080TCG	0.80 V	GG	Output Active Discharge	XDFN4 (Pb-Free)	3000 / Tape & Reel
NCP134AMX090TCG	0.90 V	GF			
NCP134AMX100TCG	1.00 V	GA			
NCP134AMX105TCG	1.05 V	GC			
NCP134AMX110TCG	1.10 V	GD			
NCP134AMX120TCG	1.20 V	GE			
NCP134AMX135TCG	1.35 V	GJ			
NCP134AMX150TCG	1.50 V	GH			
NCP134AMX180TCG	1.80 V	GK			

†For information on tape and reel specifications, including part orientation and tape sizes, please refer to our Tape and Reel Packaging Specifications Brochure, BRD8011/D.

To order other package and voltage variants, please contact your ON Semiconductor sales representative

# NCP134

## PACKAGE DIMENSIONS

### XDFN4 1.2x1.2, 0.8P CASE 711BC ISSUE O

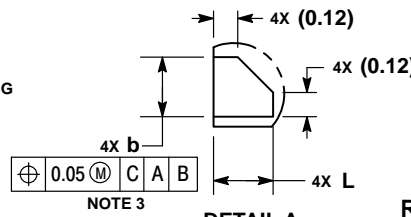
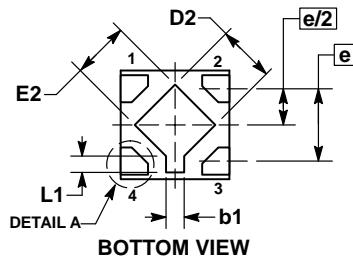
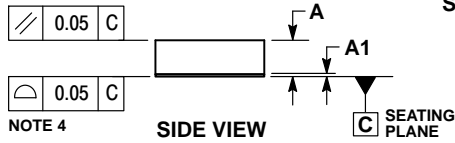
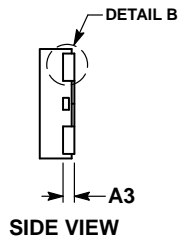
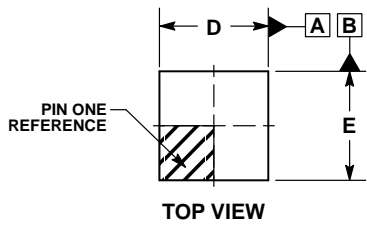

**NOTES:**

1. DIMENSIONING AND TOLERANCING PER ASME Y14.5M, 1994.
2. CONTROLLING DIMENSION: MILLIMETERS.
3. DIMENSION b APPLIES TO PLATED TERMINAL AND IS MEASURED BETWEEN 0.15 AND 0.20 mm FROM THE TERMINAL TIPS.
4. COPLANARITY APPLIES TO THE EXPOSED PAD AS WELL AS THE TERMINALS.

MILLIMETERS		
DIM	MIN	MAX
A	0.35	0.45
A1	0.00	0.05
A3	0.13	REF
b	0.25	0.35
b1	0.15	0.25
D	1.15	1.25
D2	0.58	0.68
E	1.15	1.25
E2	0.58	0.68
e	0.80	BSC
L	0.25	0.35
L1	0.13	0.23

### RECOMMENDED MOUNTING FOOTPRINT\*

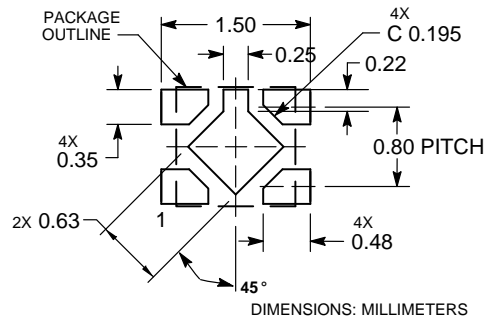

DIMENSIONS: MILLIMETERS

\*For additional information on our Pb-Free strategy and soldering details, please download the ON Semiconductor Soldering and Mounting Techniques Reference Manual, SOLDERRM/D.

ON Semiconductor and are trademarks of Semiconductor Components Industries, LLC dba ON Semiconductor or its subsidiaries in the United States and/or other countries. ON Semiconductor owns the rights to a number of patents, trademarks, copyrights, trade secrets, and other intellectual property. A listing of ON Semiconductor's product/patent coverage may be accessed at [www.onsemi.com/site/pdf/Patent-Marking.pdf](http://www.onsemi.com/site/pdf/Patent-Marking.pdf). ON Semiconductor reserves the right to make changes without further notice to any products herein. ON Semiconductor makes no warranty, representation or guarantee regarding the suitability of its products for any particular purpose, nor does ON Semiconductor assume any liability arising out of the application or use of any product or circuit, and specifically disclaims any and all liability, including without limitation special, consequential or incidental damages. Buyer is responsible for its products and applications using ON Semiconductor products, including compliance with all laws, regulations and safety requirements or standards, regardless of any support or applications information provided by ON Semiconductor. "Typical" parameters which may be provided in ON Semiconductor data sheets and/or specifications can and do vary in different applications and actual performance may vary over time. All operating parameters, including "Typicals" must be validated for each customer application by customer's technical experts. ON Semiconductor does not convey any license under its patent rights nor the rights of others. ON Semiconductor products are not designed, intended, or authorized for use as a critical component in life support systems or any FDA Class 3 medical devices or medical devices with a same or similar classification in a foreign jurisdiction or any devices intended for implantation in the human body. Should Buyer purchase or use ON Semiconductor products for any such unintended or unauthorized application, Buyer shall indemnify and hold ON Semiconductor and its officers, employees, subsidiaries, affiliates, and distributors harmless against all claims, costs, damages, and expenses, and reasonable attorney fees arising out of, directly or indirectly, any claim of personal injury or death associated with such unintended or unauthorized use, even if such claim alleges that ON Semiconductor was negligent regarding the design or manufacture of the part. ON Semiconductor is an Equal Opportunity/Affirmative Action Employer. This literature is subject to all applicable copyright laws and is not for resale in any manner.

### PUBLICATION ORDERING INFORMATION

**LITERATURE FULFILLMENT:**  
Literature Distribution Center for ON Semiconductor  
19521 E. 32nd Pkwy, Aurora, Colorado 80011 USA  
**Phone:** 303-675-2175 or 800-344-3860 Toll Free USA/Canada  
**Fax:** 303-675-2176 or 800-344-3867 Toll Free USA/Canada  
**Email:** [orderlit@onsemi.com](mailto:orderlit@onsemi.com)

**N. American Technical Support:** 800-282-9855 Toll Free  
USA/Canada  
**Europe, Middle East and Africa Technical Support:**  
Phone: 421 33 790 2910

**ON Semiconductor Website:** [www.onsemi.com](http://www.onsemi.com)  
**Order Literature:** <http://www.onsemi.com/orderlit>

For additional information, please contact your local Sales Representative