

**NO:** VS-063  
**DATE:** July 2015

**PRODUCT:** FZ4-11 Vision System Controllers  
**TYPE:** Discontinuation Notice

## FZ4-11 Vision System Controllers to be Discontinued; Replace with FZ5-11 Series and FH-3050

**Discontinuation date: September 2015**

Note: Date is subject to change based on raw materials and components availability at the factory.

### Affected Parts

Product discontinuation	Recommended replacement
FZ4-1100	FZ5-1100
FZ4-1100-10	FZ5-1100-10
FZ4-1105	FZ5-1105
FZ4-1105-10	FZ5-1105-10
FZ4-1150	FH-3050
FZ4-1150-10	FH-3050-10
FZ4-1155	FH-3050
FZ4-1155-10	FH-3050-10



FZ4-1100



FZ4-1150



### Cautions on Applying Replacements

- The camera, camera cable, lens and illumination, etc. can be used, when FZ4 series are changed to FH series. However, the parallel I/O cable cannot be used with the FH series.
- The FZ4 parallel I/O cables cannot be used with the FH series. If using FZ-VP parallel I/O cable, replace it with 2 each of XW2Z-S013. If using FZ-VPX parallel I/O cable, replace it with 2 each of XW2Z-XXXEE with terminal block XW2R-X34G-T.
- When connecting FH series to an RGB analog monitor, use the DVI-I-RGB Conversion Connector Model FH-VMRGB (for FH Series only).
- Confirm the measuring time etc. before changing over to the FH Series because these series have different CPUs.

# Details of Differences

## Body Color

Product discontinuation Model FZ4-110x Series	Recommended replacement Model FZ5-110x Series
	

Product discontinuation Model FZ4-115x Series	Recommended replacement Model FH-3050 Series
	

## Wire Connection

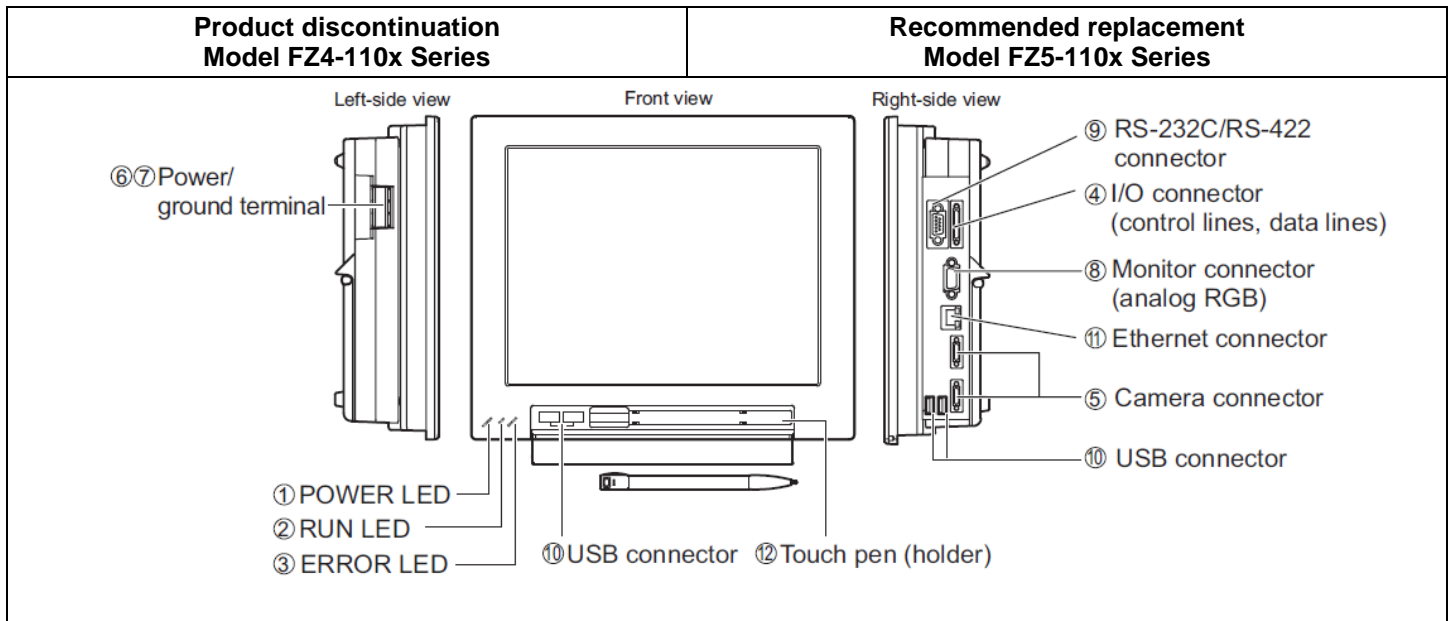

**Product discontinuation  
Model FZ4-115x Series**

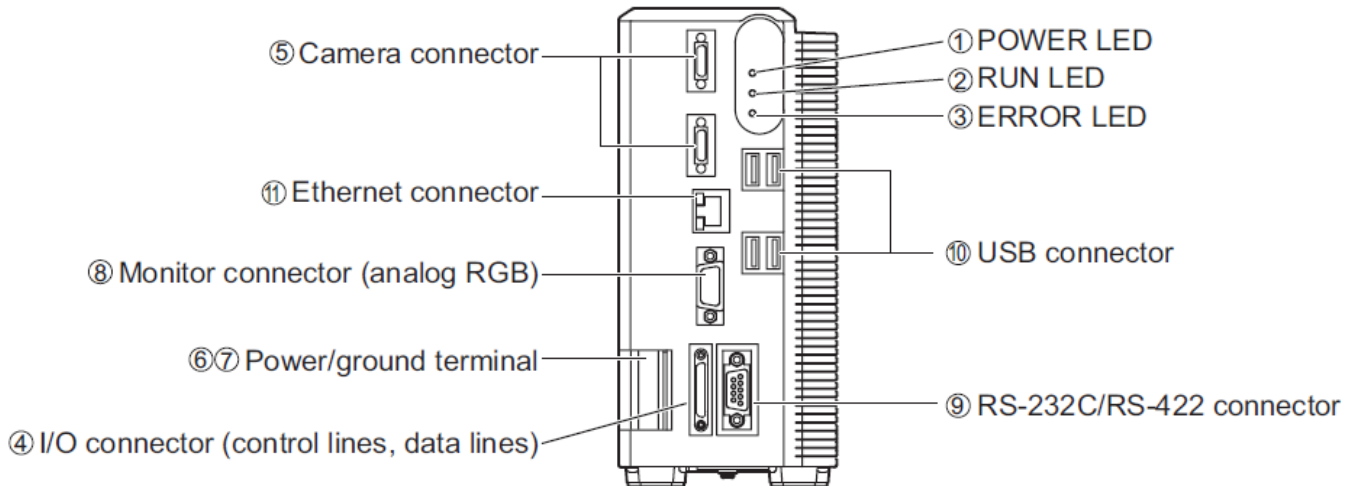

**Recommended replacement  
Model FH-3050 Series**

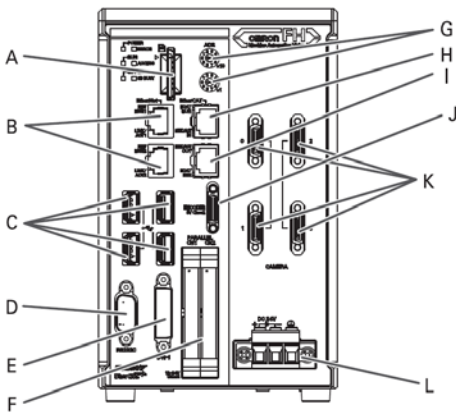

Connector name	Description				
A SD memory card installation connector	Install the SD memory card. Do not plug or unplug the SD memory card during measurement operation, Otherwise measurement time may be affected or data may be destroyed.				
B EtherNet connector	<p>Connect an EtherNet device.</p> <table border="1"> <thead> <tr> <th>Camera 2ch type</th> <th>Camera 4ch / 8ch type</th> </tr> </thead> <tbody> <tr> <td> <p>Ethernet port and EtherNet/IP port are sharing use.</p> </td> <td> <p>Upper port : Ethernet port Lower port : Ethernet port and EtherNet/IP port are sharing use.</p> </td> </tr> </tbody> </table>	Camera 2ch type	Camera 4ch / 8ch type	<p>Ethernet port and EtherNet/IP port are sharing use.</p>	<p>Upper port : Ethernet port Lower port : Ethernet port and EtherNet/IP port are sharing use.</p>
Camera 2ch type	Camera 4ch / 8ch type				
<p>Ethernet port and EtherNet/IP port are sharing use.</p>	<p>Upper port : Ethernet port Lower port : Ethernet port and EtherNet/IP port are sharing use.</p>				
C USB connector	Connect a USB device. Do not plug or unplug it during measurement. Measurement time might be affected otherwise.				
D RS-232C connector	Connect an external device such as a PLC.				
E DVI-I connector	Connect a monitor.				
F I/O(Parallel) connector(control lines, data lines)	Connect the controller to external devices such as a sync sensor and PLC.				
G EtherCAT address setup volume	Used to set a station address ( 00 to 99) as an EtherCAT communication device.				
H EtherCAT communication connector (IN)	Connect the opposed EtherCAT device.				
I EtherCAT communication connector (OUT)	Connect the opposed EtherCAT device.				
J Encoder connector	Connect an encoder.				
K Camera connector	Camera connector No. is consistent with Camera Image Input No. of Sensor controller software. Check and connect them.				
L Power supply terminal connector	Connect a DC power supply. Wire the FH Sensor Controller independently on other devices. Wire the ground line. Be sure to ground the FH Sensor Controller alone. Perform wiring using the attached terminal block connector as referring to the description of wiring that connector.				

## Mounting Dimensions

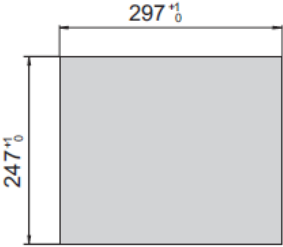
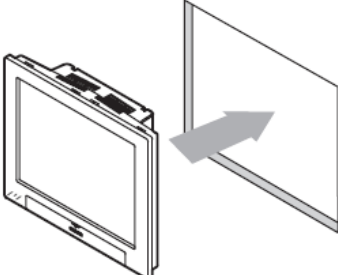
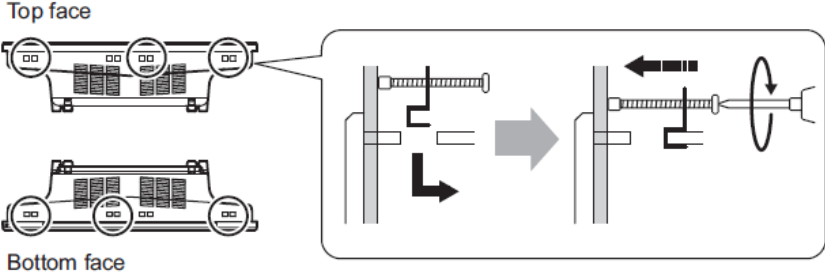
Product discontinuation Model FZ4-110x Series	Recommended replacement Model FZ5-110x Series
<p>● LCD integrated type</p>	
<p>• Panel mounting</p>	
<p>① Make a mount hole on the panel. Panel thickness range: 1.6 to 4.8 mm Panel material: Metal (iron, aluminum or stainless)</p>	<p>(Unit: mm)</p>  <p>* No burr allowed</p>
<p>② Insert the LCD integrated controller into the hole, from the front panel.</p>	
<p>③ Use the bracket (supplied with the product) to secure the controller and the panel.</p> <p>Tightening torque: 0.5 to 0.6 Nm</p>	 <p>Top face</p> <p>Bottom face</p>
<p>• Mounting the controller to the optional desktop stand.</p> <p>The controller can be placed on a desk by attaching the optional desktop stand (FZ-DS) to the rear of the controller.</p> <p>* For details, refer to the instruction manual of the desktop stand.</p>	<p>• Mounting the controller to the optional VESA attachment unit.</p> <p>VESA-compatible mounting of the controller is possible by attaching the optional VESA attachment unit (FZ-VESA) to the rear of the controller.</p> <p>* For details, refer to the instruction manual of the VESA attachment unit.</p>

## Product discontinuation Model FZ4-115x Series

### ● Box type

• Side mounting

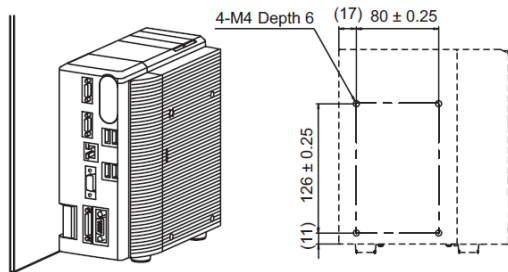

• Bottom mounting

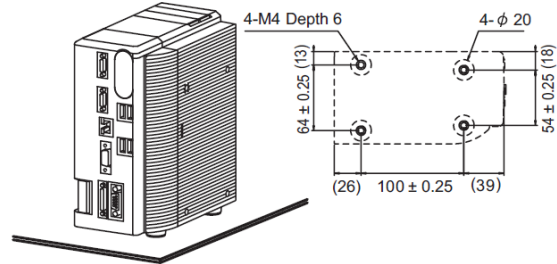

\* When mounting the controller on its bottom, it must be fixed without removing the feet to reserve ventilation path.

## Recommended replacement Model FH-3050 Series

### ● Side Mounting

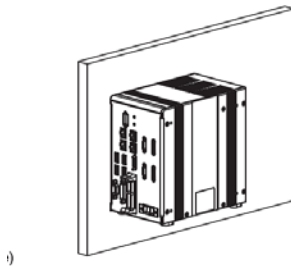

(Unit: mm)

• Left side

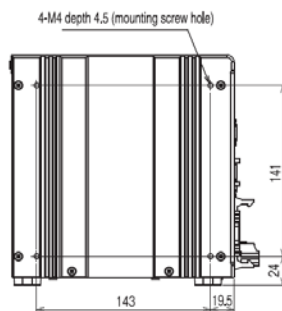

• Right side

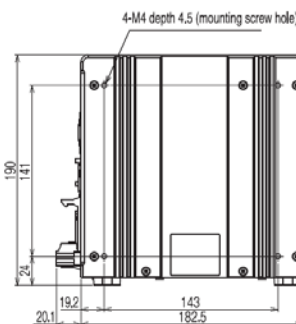

\* Recommended tightening torque: 1.2N·m to 1.3N·m  
\*The tolerance is ± 0.2mm.

### ● Bottom Mounting

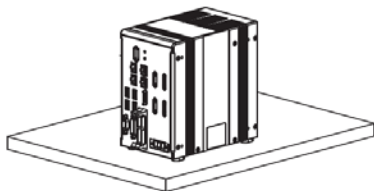

• Bottom

(Unit: mm)

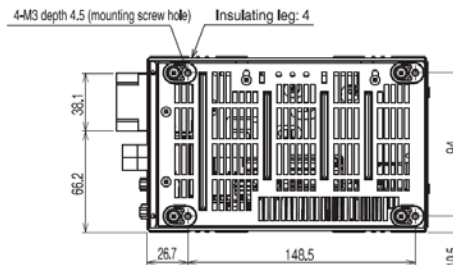

\* Do not remove the Insulating leg. Fix the Insulating leg to secure the ventilation path.  
\* Recommended tightening torque: 0.54N·m to 0.6N·m  
\*The tolerance is ± 0.2mm.

• Camera cable mounting

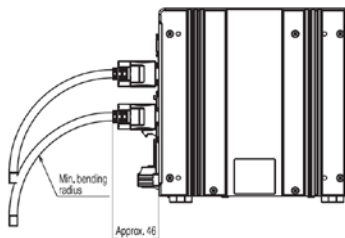

# Dimensions

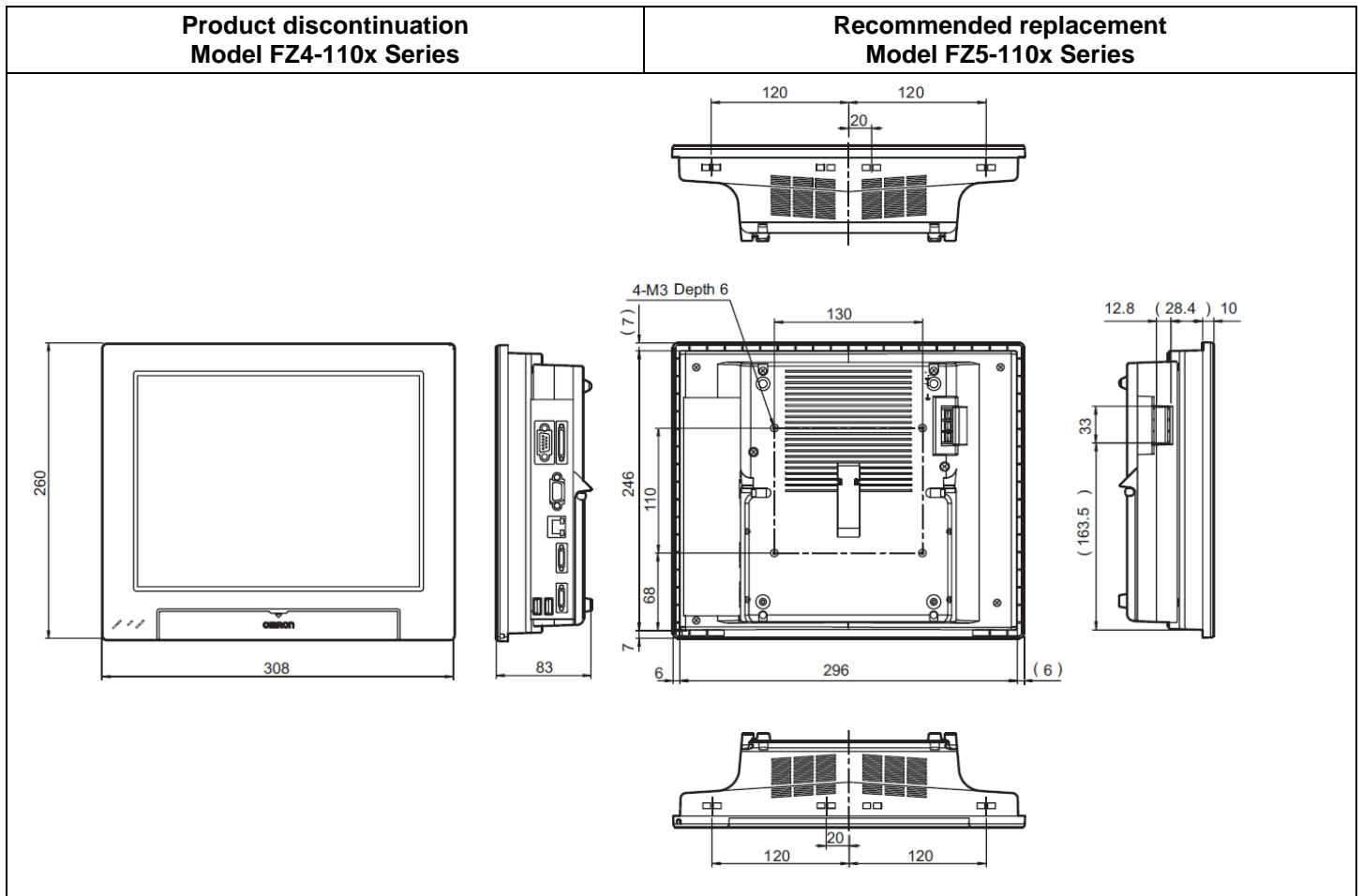

**Product discontinuation  
Model FZ4-115x Series**

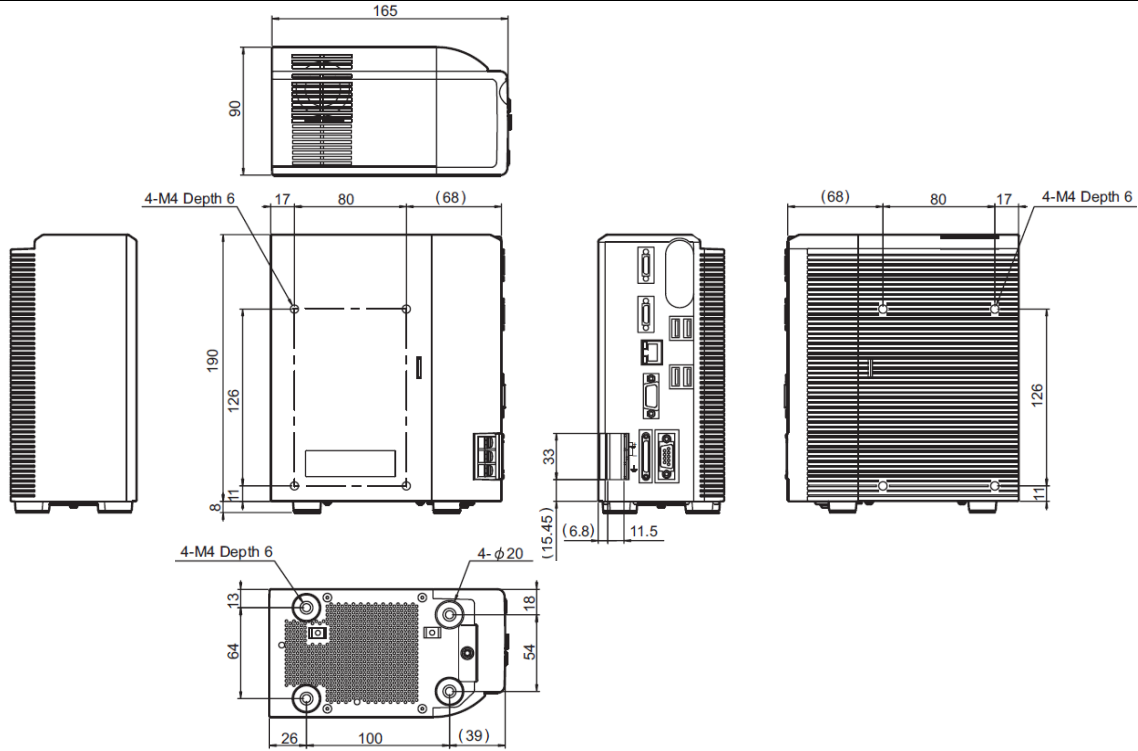

**Recommended replacement  
Model FH-3050 Series**

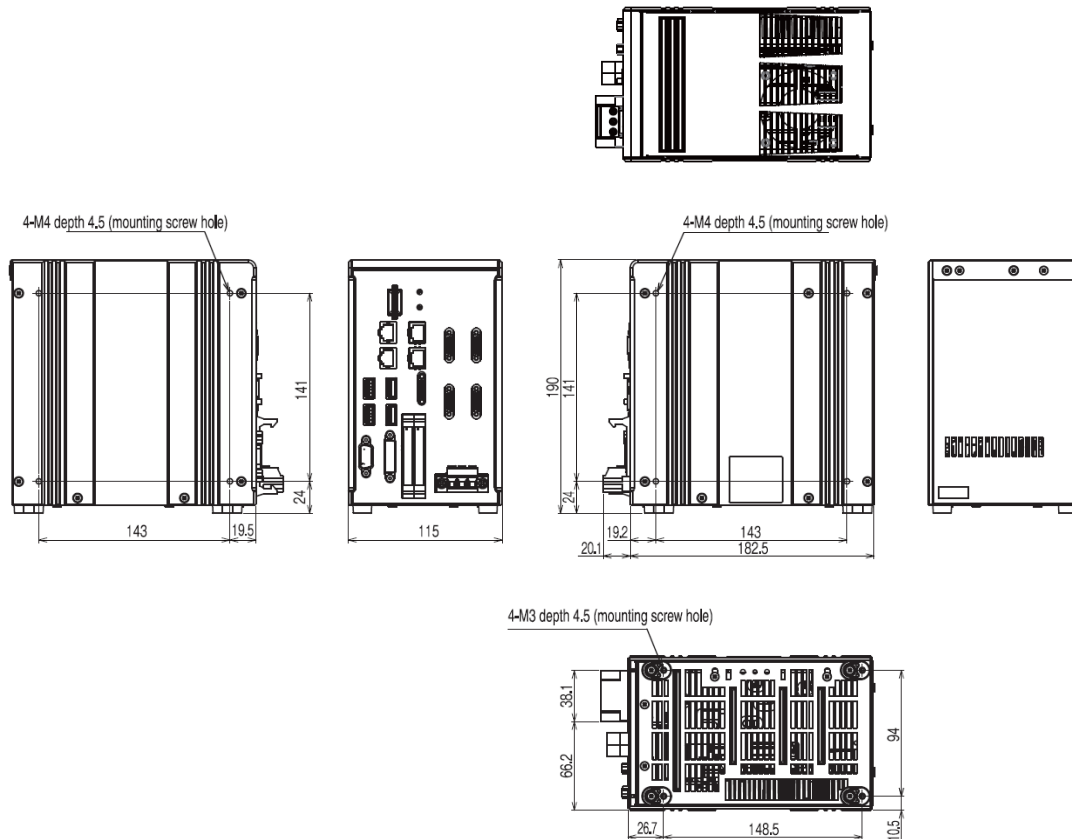

# System Configuration

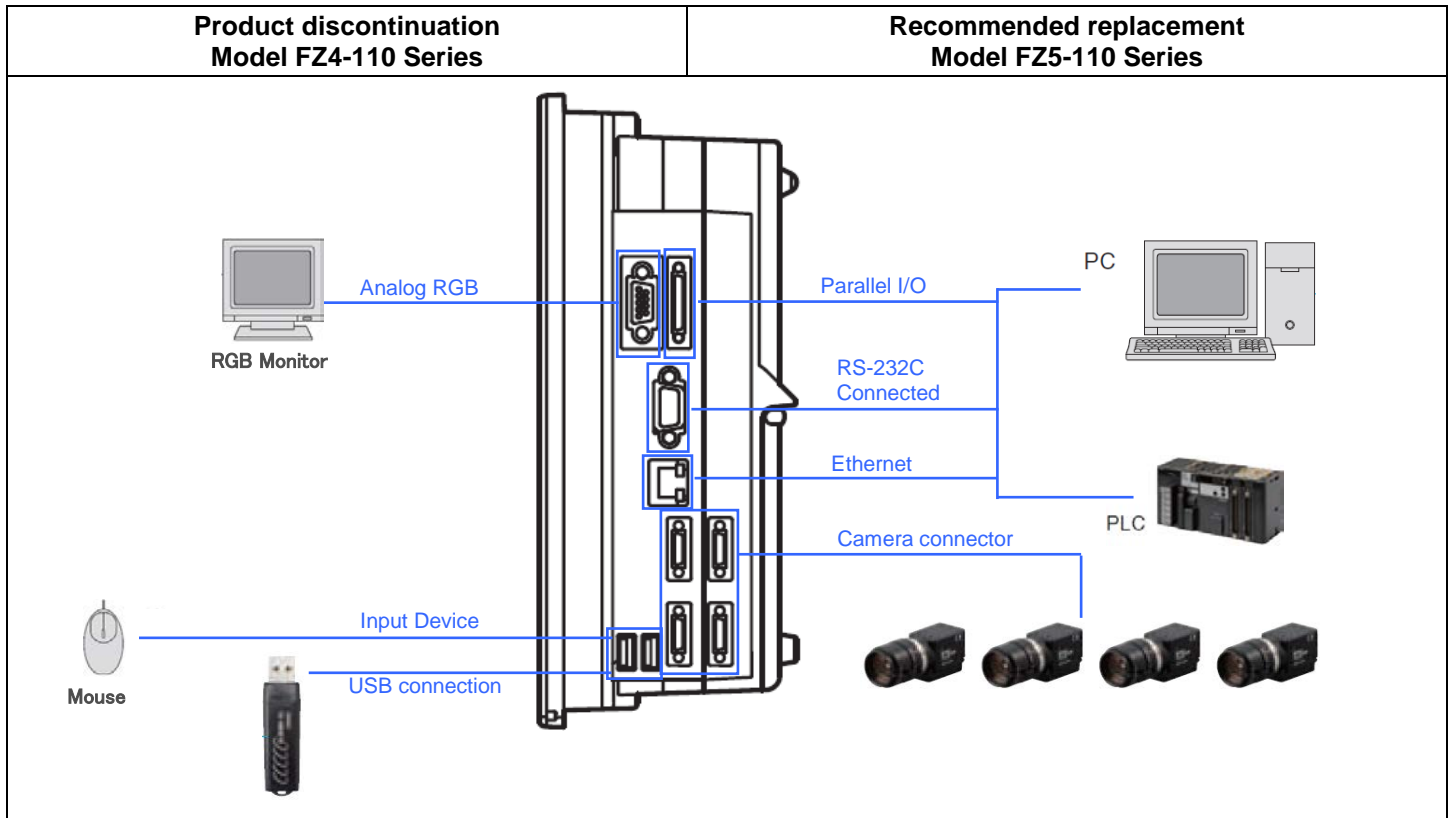



**Product discontinuation  
Model FZ4-115x Series**

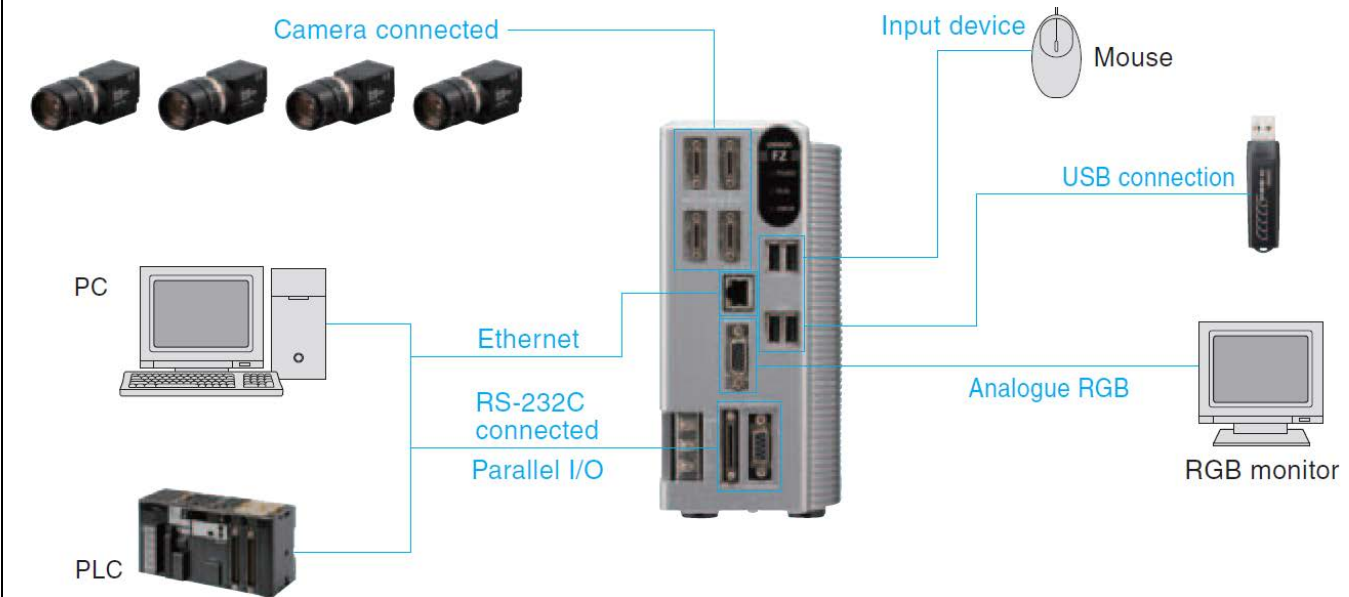

**Recommended replacement  
Model FH-3050 Series**

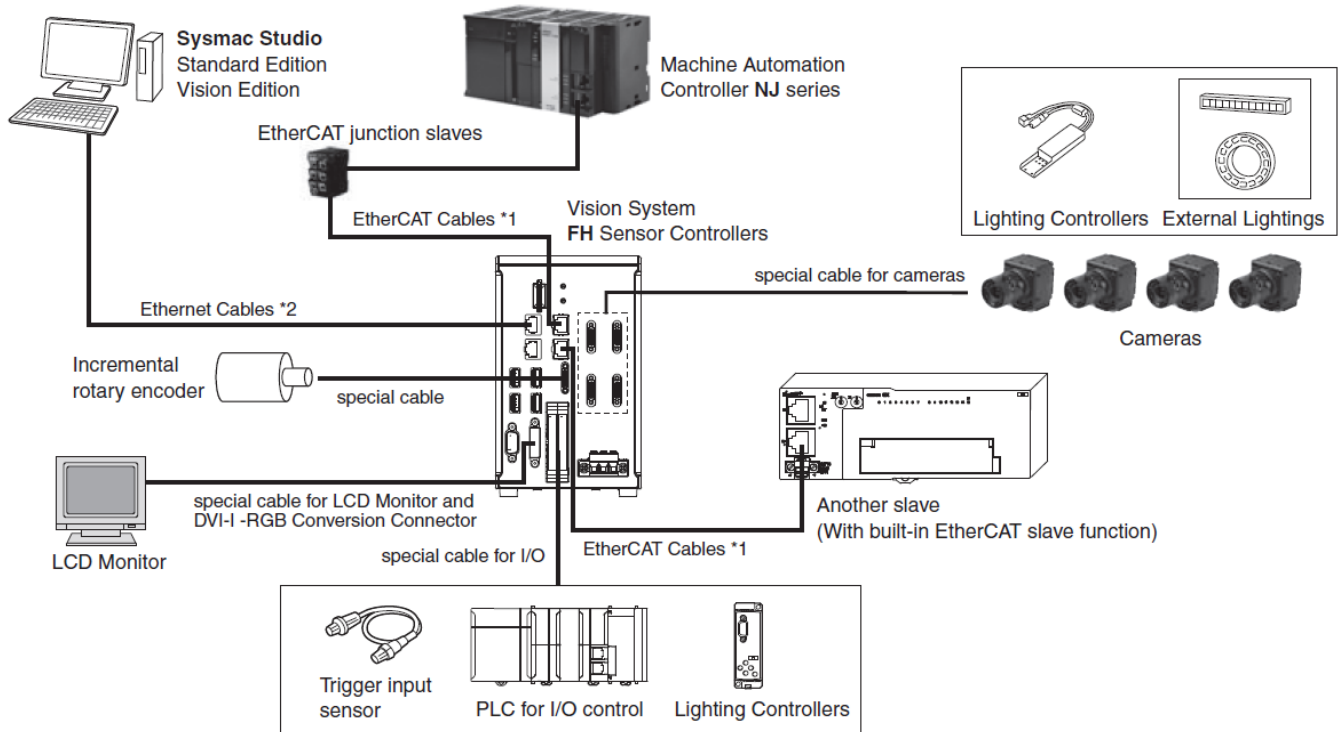

\*1. To use STP (shielded twisted-pair) cable of category 5 or higher with double shielding (braiding and aluminum foil tape) for EtherCAT and RJ45 connector.  
\*2. To use STP (shielded twisted-pair) cable of category 5 or higher for Ethernet and RJ45 connector.

## Specifications

Item		Product discontinuation Model FZ4-110x Series		Recommended replacement Model FZ5-110x Series	
Model	NPN	FZ4-1100	FZ4-1100-10	FZ5-1100	FZ5-1100-10
	PNP	FZ4-1105	FZ4-1105-10	FZ5-1105	FZ5-1105-10
Controllers type		LCD integrated type			
No. of cameras		2 camera type	4 camera type	2 camera type	4 camera type
Connected camera		FZ-S series (When connecting 5 million-pixel cameras, up to two cameras can be connected.)			
No. of scenes		32		128	
Operation		Mouse etc.			
Settings		Create series of processing steps by editing the flowchart (Help messages provided).			

Item		Product discontinuation Model FZ4-115x Series		Recommended replacement Model FH-3050 Series	
Model	NPN	FZ4-1150	FZ4-1150-10	FH-3050	FH-3050-10
	PNP	FZ4-1155	FZ4-1155-10	FH-3050	FH-3050-10
Controllers type		Box type			
No. of cameras		2 camera type	4 camera type	2 camera type	4 camera type
Connected camera		FZ-S series (When connecting 5 million-pixel cameras, up to two cameras can be connected.)		FZ-S/FH-S series	
No. of scenes		32		128	
Operation		Mouse etc.			
Settings		Create series of processing steps by editing the flowchart (Help messages provided).			

## Processing Resolution

Item	Product discontinuation Model FZ4-110x Series	Recommended replacement Model FZ5-110x Series
When connected to an intelligent compact camera	752(H) × 480(V)	
When connected to a 300,000-pixel camera	640(H) × 480(V)	
When connected to a 2 million-pixel camera	1600(H) × 1200(V)	
When connected to a 5 million-pixel camera	2448(H) × 2044(V)	

Item	Product discontinuation Model FZ4-115x Series	Recommended replacement Model FH-3050 Series
When connected to an intelligent compact camera	752(H) × 480(V)	FZ-S: 752(H) × 480(V)
When connected to a 300,000-pixel camera	640(H) × 480(V)	FZ-S: 640(H) × 480(V) FH-S: 640(H) × 480(V)
When connected to a 2 million-pixel camera	1600(H) × 1200(V)	FZ-S: 1600(H) × 1200(V) FH-S: 2040(H) × 1088(V)
When connected to a 4 million-pixel camera	—	FH-S: 2040(H) × 2048(V)
When connected to a 5 million-pixel camera	2448(H) × 2044(V)	FZ-S: 2448(H) × 2044(V)
When connected to a 12 million-pixel camera	—	FH-S: 4084(H) × 3072(V)

## Number of Logged Images \*1

Item		Product discontinuation Model FZ4-110 Series	Recommended replacement Model FZ5-110 Series
When connected to an intelligent compact camera	Connected to 1 camera	232	232
	Connected to 2 cameras	116	116
	Connected to 3 cameras	77	77
	Connected to 4 cameras	58	58
When connected to a 300,000-pixel camera	Connected to 1 camera	Color	270
		Monochrome	272
	Connected to 2 cameras	Color	135
		Monochrome	136
	Connected to 3 cameras	Color	90
		Monochrome	90
	Connected to 4 cameras	Color	67
		Monochrome	68
When connected to a 2 million-pixel camera	Connected to 1 camera	Color	43
		Monochrome	43
	Connected to 2 cameras	Color	21
		Monochrome	21
	Connected to 3 cameras	Color	14
		Monochrome	14
	Connected to 4 cameras	Color	10
		Monochrome	10
When connected to a 5 million-pixel camera	Connected to 1 camera	Color	16
		Monochrome	16
	Connected to 2 cameras	Color	8
		Monochrome	8
	Connected to 3 camera	Color	5
		Monochrome	5
	Connected to 4 cameras	Color	4
		monochrome	4

\* 1. The image logging capacity changes when multiple cameras of different types are connected at the same time.

Item		Product discontinuation Model FZ4-115x Series	Recommended replacement Model FH-3050 Series		
When connected to a intelligent compact camera (FZ-S)	Connected to 1 camera	232	232		
	Connected to 2 cameras	116	116		
	Connected to 3 cameras	77	77		
	Connected to 4 cameras	58	58		
When connected to a 300,000-pixel camera	Connected to 1 camera	Color	270 (FZ-S)	270 (FZ-S, FH-S)	
		Monochrome	272 (FZ-S)	272 (FZ-S, FH-S)	
	Connected to 2 cameras	Color	135 (FZ-S)	135 (FZ-S, FH-S)	
		Monochrome	136 (FZ-S)	136 (FZ-S, FH-S)	
	Connected to 3 cameras	Color	90 (FZ-S)	90 (FZ-S, FH-S)	
		Monochrome	90 (FZ-S)	90 (FZ-S, FH-S)	
	Connected to 4 cameras	Color	67 (FZ-S)	67 (FZ-S, FH-S)	
		Monochrome	68 (FZ-S)	68 (FZ-S, FH-S)	
When connected to a 2 million-pixel camera	Connected to 1 camera	Color	43 (FZ-S)	37 (FH-S), 43 (FZ-S)	
		Monochrome	43 (FZ-S)	37 (FH-S), 43 (FZ-S)	
	Connected to 2 cameras	Color	21 (FZ-S)	18 (FH-S), 21 (FZ-S)	
		Monochrome	21 (FZ-S)	18 (FH-S), 21 (FZ-S)	
	Connected to 3 cameras	Color	14 (FZ-S)	12 (FH-S), 14 (FZ-S)	
		Monochrome	14 (FZ-S)	12 (FH-S), 14 (FZ-S)	
	Connected to 4 cameras	Color	10 (FZ-S)	9 (FH-S), 10 (FZ-S)	
		Monochrome	10 (FZ-S)	9 (FH-S), 10 (FZ-S)	
	When connected to a 4 million-pixel Camera (FH-S)	Connected to 1 camera	Color	—	20 (FH-S)
			Monochrome	—	20 (FH-S)
Connected to 2 cameras		Color	—	10 (FH-S)	
		Monochrome	—	10 (FH-S)	
Connected to 3 cameras		Color	—	6 (FH-S)	
		Monochrome	—	6 (FH-S)	
Connected to 4 cameras		Color	—	5 (FH-S)	
		Monochrome	—	5 (FH-S)	
When connected to a 5 million-pixel Camera (FZ-S)	Connected to 1 camera	Color	16 (FZ-S)	16 (FZ-S)	
		Monochrome	16 (FZ-S)	16 (FZ-S)	
	Connected to 2 cameras	Color	8 (FZ-S)	8 (FZ-S)	
		Monochrome	8 (FZ-S)	8 (FZ-S)	
	Connected to 3 cameras	Color	5 (FZ-S)	5 (FZ-S)	
		Monochrome	5 (FZ-S)	5 (FZ-S)	
	Connected to 4 cameras	Color	4 (FZ-S)	4 (FZ-S)	
		Monochrome	4 (FZ-S)	4 (FZ-S)	
When connected to a 12 million-pixel Camera (FH-S)	Connected to 1 camera	Color	—	6 (FH-S)	
		Monochrome	—	6 (FH-S)	
	Connected to 2 cameras	Color	—	3 (FH-S)	
		Monochrome	—	3 (FH-S)	
	Connected to 3 cameras	Color	—	2 (FH-S)	
		Monochrome	—	2 (FH-S)	
	Connected to 4 cameras	Color	—	2 (FH-S)	
		Monochrome	—	2 (FH-S)	

\* 1. The image logging capacity changes when multiple cameras of different types are connected at the same time.

## Ratings

Item		Product discontinuation		Recommended replacement	
		FZ4-1100 FZ4-1105	FZ4-1100-10 FZ4-1105-10	FZ5-1100 FZ5-1105	FZ5-1100-10 FZ5-1105-10
<b>Power supply voltage</b>		DC20.4 ~26.4V			
<b>Current consumption (at 24.0 VDC) *1</b>	<b>When connected to a intelligent compact camera</b>	5.0A max.	7.5 max.	5.0A max.	7.5 max.
	<b>When connected to a 300,000-pixel camera</b>	3.7A max.	4.9A max.	3.7A max.	4.9A max.
	<b>When connected to a 2 million-pixel camera</b>				
	<b>When connected to a 5 million-pixel camera</b>				
<b>Weight</b>		Approx 3.2kg	Approx 3.4kg	Approx 3.2kg	Approx 3.4kg
<b>Accessories</b>		Touch pen , Instruction manual, 6 mounting brackets			

Note 1: The current consumption when the maximum number of cameras supported by each controller is connected.  
If a strobe controller model is connected to a lamp, the current consumption is as high as when an intelligent camera is connected.

Item		Product discontinuation		Recommended replacement	
		FZ4-1150 FZ4-1155	FZ4-1150-10 FZ4-1155-10	FH-3050	FH-3050-10
<b>Power supply voltage</b>		DC20.4 ~26.4V			
<b>Current consumption (at 24.0 VDC) *1</b>	<b>When connected to a intelligent compact camera</b>	5.0A max.	7.5A max.	5.0A (2 Camera)	5.4A (2 Camera) 7.0A (4 Camera)
	<b>When connected to a 300,000-pixel camera</b>	3.7A max.	4.9A max.	4.1A (2 Camera)	4.2A (2 Camera) 4.8A (4 Camera)
	<b>When connected to a 2 million-pixel camera</b>	3.7A max.	4.9A max.		
	<b>When connected to a 4 million-pixel camera</b>	--	--		
	<b>When connected to a 5 million-pixel camera</b>	3.7A max.	4.9A max.		
	<b>When connected to a 12 million-pixel camera</b>	--	--		
<b>Weight</b>		Approx 1.8kg	Approx 1.9kg	Approx 3.2kg	Approx 3.4kg
<b>Accessories</b>		Instruction Sheet		Instruction Sheet Instruction installation manual Terminal block connector Ferrite core	

Note 1: The current consumption when the maximum number of cameras supported by each controller is connected.  
If a strobe controller model is connected to a lamp, the current consumption is as high as when an intelligent camera is connected.

## Operation Environment

Item		Product discontinuation Model FZ4-110x Series	Recommended replacement Model FZ5-110x Series
Ambient temperature range	Operating	Ambient temperature specifiable. The cooling fan speed can be switched according to the setting. 0 to 45°C :Low speed 0 to 50°C :High speed	
	Storage	-20 to 65°C (with no icing or condensation)	
Ambient humidity range	Operating	35 to 85% RH (with no condensation)	
	Storage		

Item		Product discontinuation Model FZ4-115x Series	Recommended replacement Model FH-3050 Series
Ambient temperature range	Operating	0 to 50°C	
	Storage	-20 to 65°C (with no icing or condensation)	
Ambient humidity range	Operating	35 to 85% RH (with no condensation)	

## External Interface

Item	Product discontinuation Model FZ4-110x Series	Recommended replacement Model FZ5-110x Series
Serial communications	RS-232C: 1CH	
EtherNet communications	Ethernet 1000BASE-T/100BASE-TX/10BASE-T	
EtherNet/IP communications	Ethernet port baud rate: 100Mbps (100BASE-TX)	
Parallel I/O interface	<p>17 inputs RESET,STEP0/ENCTRIG_Z0,STEP1/ENCTRIG_Z1,DSA0~1, ENCTRIG_A0~1,ENCTRIG_B0~1,DI0~7</p> <p>29 outputs RUN/BUSY1,BUSY0,GATE0~1,OR0~1,READY0~1, ERROR,STGOUT0~1,DO0~15</p> <p>* STGOUT2 to 3 only for camera 4 ch type</p>	
Monitor interface	Integrated Controller and 12.1 inch TFT color LCD (Resolution : XGA 1,024 x 768 dots) Analog RGB video output,1 channel	
USB interface	4 channels (supports USB 1.1 and 2.0)	

Item	Product discontinuation Model FZ4-115x Series	Recommended replacement Model FH-3050 Series
<b>Serial communications</b>	RS-232C/422: 1CH	RS-232C: 1CH
<b>EtherNet communications</b>	Ethernet 100BASE-TX/10BASE-T	Ethernet 1000BASE-T
<b>EtherNet/IP communications</b>	Use Ethernet port Transmission Speed: 100 Mbps (100BASE-TX)	Use Ethernet port Transmission Speed: 1 Gbps (1000BASE-TX)
<b>EtherCAT communications</b>	--	EtherCAT dedicated protocol(100BASE-TX)
<b>Parallel I/O interface</b>	<p><u>17 inputs</u> RESET,STEP0/ENCTRIG_Z0, STEP1/ENCTRIG_Z1,DSA0~1, ENCTRIG_A0~1,ENCTRIG_B0~1, DI0~7</p> <p><u>29 outputs</u> RUN/BUSY1,BUSY0,GATE0~1, OR0~1,READY0~1 ERROR,STGOUT0~3,DO0~15</p> <p>* STGOUT2 to 3 only for camera 4 ch type</p>	<p>•In the 2-line random trigger mode <u>17 inputs</u> STEP0/ENCTRIG_Z0, STEP1/ENCTRIG_Z1, ENCTRIG_A0~1,ENCTRIG_B0~1, DSA0~1,DI0~7,DI_LINE0</p> <p><u>37 outputs</u> RUN0~1,READY0~1,BUSY0~1,OR0~1, ERROR0~1,GATE0~1, STGOUT0/SHTOUT0 STGOUT1/SHTOUT1 STGOUT2~7,DO0~15,ACK</p> <p>•In the 5-line to 8-line random trigger mode <u>19 inputs</u> STEP0~7,DI_LINE0~2, DI0~7</p> <p><u>34 outputs</u> READY0~7,BUSY0~7,OR0~7 ACK,ERROR,STGOUT/SHTOUT0~7</p>
<b>Encoder interface</b>	--	RS422-A line driver level. Phase A/B :single-phase 4MHz (multiplying phase difference of 1MHz by 4 times), Phase Z :1MHz
<b>Monitor interface</b>	Analog RGB video output,1 channel (Resolution : XGA 1,024 x 768 dots)	DVI-I (Single Link) output IF x 1ch
<b>USB interface</b>	4 channels (supports USB 1.1 and 2.0)	4 channels (supports USB 1.1 and 2.0)
<b>SD card interface</b>	--	SDHC card of Class4 or higher rating is recommended.

## Processing Items

	Item	Product discontinuation Model FZ4-11xx Series	Recommended replacement Model FZ5-110x Series Model FH-3050 Series
Inspections / Measurement	Search	YES	YES
	Flexible Search	YES	YES
	Sensitive Search	YES	YES
	ECM Search	YES	YES
	EC Circle Search	YES	YES
	Shape Search+	YES	NO
	Shape Search II	YES	YES
	Shape Search III	NO	YES
	EC Corner	YES	YES
	EC Cross	NO	YES
	Classification	NO	YES
	Edge Position	YES	YES
	Edge Pitch	YES	YES
	Scan Edge Position	YES	YES
	Scan Edge Width	YES	YES
	Circular Scan Edge Position	YES	YES
	Circular Scan Edge Width	YES	YES
	Intersection	NO	YES
	Color Data	YES	YES
	Gravity and Area	YES	YES
	Labeling	YES	YES
	Label Data	YES	YES
	Labeling+	YES	NO
	Defect	YES	YES
	Precise Defect	YES	YES
	Fine Matching	YES	YES
	Character Inspection	YES	YES
	Date Verification	YES	YES
	Model Dictionary	YES	YES
	Barcode+ *1	YES	NO
	Barcode *1	YES	YES
	2D Code *2	YES	YES
	2D Code+ *2	YES	NO
OCR User Dictionary	NO	YES	
OCR	NO	YES	
Circle Angle	YES	YES	
Glue Bead Inspection	NO	YES	
Input image	Camera Image Input	YES	YES
	Camera Image Input FH	NO	YES
	Camera Image Input HDR	YES	YES
	Camera Image Input HDR Lite	YES	YES
	Camera Switching	YES	YES
	Measurement Image Switching	YES	YES

\*1 Bar Codes that can be read:  
 JAN/EAN/UPC (including add-on codes), Code 39, Codabar (NW-7), IFT (Interleaved 2 of 5), Code 93, Code128,  
 GS1 DataBar (RSS-14/RSS Limited/RSS Expanded), PharmaCode

\*2 2D Codes that can be read: Data Matrix, QR Code



## Processing Items

	Item	Product discontinuation Model FZ4-11xx Series	Recommended replacement Model FZ5-110x Series Model FH-3050 Series
Correcting Images	Position compensation	YES	YES
	Trapezoidal Correction	NO	YES
	Trapezoidal Correction+	YES	NO
	Filtering	YES	YES
	Background Suppression	YES	YES
	Brightness Correct filter	YES	YES
	Color Gray filter	YES	YES
	Extract Color Filter	YES	YES
	Anti Color shading	YES	YES
	Stripes Removal Filter+	YES	NO
	Stripes Removal Filter II	YES	YES
	Halation Cut+	YES	NO
	Panorama+	YES	NO
	Polar Transformation	YES	YES
	Machine Simulator	NO	YES
	Image Subtraction	NO	YES
	Advanced Filter	NO	YES
	Panorama	NO	YES
Assisting inspections / Measurement	Unit Macro	NO	YES
	Unit calculation macro	NO	YES
	Calculation	YES	YES
	Line Regression	YES	YES
	Circle Regression	YES	YES
	Calibration+	YES	NO
	Precise Calibration	YES	YES
	User Data	YES	YES
	Set Unit data	YES	YES
	Get Unit Data	YES	YES
	Set Unit Figure	YES	YES
	Get Unit Figure	YES	YES
	Trend Monitor	YES	YES
	Image Logging	YES	YES
	Image Conversion Logging	YES	YES
	Data Logging	YES	YES
	Elapsed Time	YES	YES
	Wait	YES	YES
	focus	YES	YES
	Iris	YES	YES
	Parallelize	NO	YES
	Parallelize Task	NO	YES
	Statistics	NO	YES
	Reference Calib Data	NO	YES
	Position Data calculation	NO	YES
	Robot Data	NO	YES
	Vision Master Calibration	NO	YES
	PLC Master Calibration	NO	YES
	Convert Position Data	NO	YES
	Movement Single Position	NO	YES
	Movement Multi Points	NO	YES
Detection Point	NO	YES	
Camera calibration	NO	YES	
Data Save	NO	YES	
Stage Data	NO	YES	

## Processing Items

Item		Product discontinuation Model FZ4-11xx Series	Recommended replacement Model FZ5-110x Series Model FH-3050 Series
Branching processing	Conditional Branch	YES	YES
	End	YES	YES
	DI branch	YES	YES
	Control Flow Normal	YES	YES
	Control Flow PLC Link	YES	YES
	Control Flow Parallel	YES	YES
	Control Flow Fieldbus	YES	YES
	Selective Branch	NO	YES
Outputting results	Data Output	YES	YES
	Parallel Data Output	YES	YES
	Parallel Judgement Output	YES	YES
	Fieldbus Data Output	YES	YES
Displaying results on the monitor	Result Display	YES	YES
	Display Image File	YES	YES
	Display Last NG Image	YES	YES

Specifications and prices in this product news are as of the issue date and are subject to change without notice. Only main changes in specifications are described in this document. Please be sure to read the relevant catalogs, datasheets, product specifications, instructions, and manuals for precautions and necessary information when using products.