

## High Capacity and High Dielectric Strength Miniature Relay with Fully Sealed Construction in 5 A (8 A) SPST-NO(1a), SPST-NO+SPST-NC(1a1b), DPST-NO(2a), DPST-NC(2b) Types

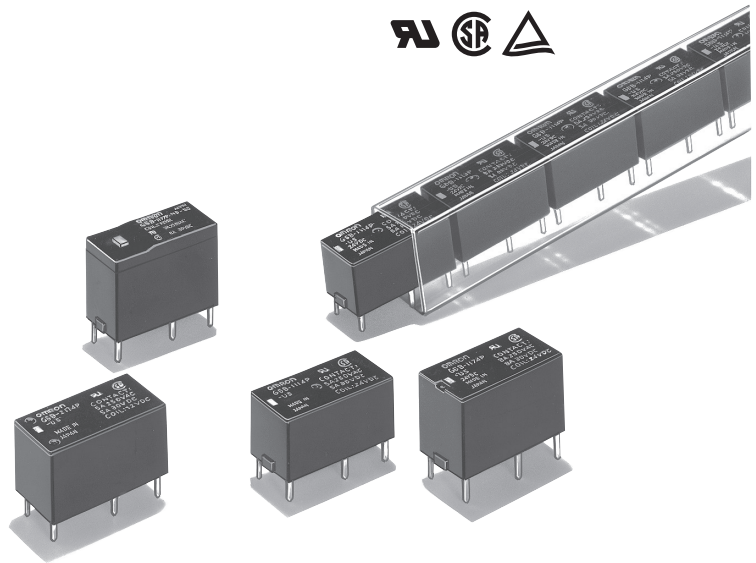

- P6B model for connecting sockets are available.
- High insulation with dielectric strength of 3,000VAC between coil and contacts (impulse withstand voltage of 6 kV).
- Standard model conforms to UL/CSA standards.
- AgSnIn contacts suitable for loads that generate surge voltage (inductive load, capacity load, etc.) are available. (-FD type)
- Ultrasonic cleanable models are available. (-U type)
- Operation indicator & built-in surge absorption diode models are available. (-ND type)
- 2-Pole type available.
- High-reliability models are available.

G6B-1184P-US model (The relay used in Terminal Relay G6B-48BND)

### Application Examples

- Ideal for output applications of control equipments

### Model Number Legend

G6B□-□□□□□□-□-□-□-□-□-□  
 1 2 3 4 5 6 7 8 9 10 11

#### 1. Relay Function

- None: Single-side stable  
 U : Single-winding latching (G6B□-1114 models only)  
 K : Double-winding latching (G6B□-1114 models only)

#### 2. Contact Form

- 21: SPST-NO + SPST-NC  
 22: DPST-NO  
 20: DPST-NC  
 11: SPST-NO

#### 3. Classification

- 1: Standard  
 7: High-capacity  
 8: Single crossbar

#### 4. Enclosure rating

- 4: Fully sealed  
 7: Flux protection

#### 5. Terminal Shape

- P: Straight PCB terminals  
 Socket mounting terminals  
 C: Self-clinching PCB

#### 6. Contact material

- None: Standard (Ag-alloy (Cd free))  
 FD : AgSnIn contact  
 (Suitable for DC inductive load with high inrush current)

#### 7. Coil Polarity

- None: 5, 6 Terminal (+), 1, 2 Terminal (-)  
 1 : 5, 6 Terminal (-), 1, 2 Terminal (+)

#### 8. Operation Indicator Diode Availability

- None: Standard  
 ND : Operation indicator & coil surge absorption diode  
 (for -1177 type only)

#### 9. Approved Standards

US: UL/CSA

#### 10. Washability

- None: Standard  
 U : For ultrasonically cleanable

#### 11. Mounting

- None: Mounted directly to PCB  
 P6B : Mounted to Socket

## Ordering Information

### Standard Models (UL, CSA certified)

Number of poles	Relay Function	Contact form	Contact material Terminals	Standard (Ag-alloy (Cd free))		AgSnIn contact		Minimum packing unit
				Model	Rated coil voltage	Model	Rated coil voltage	
1-pole	Single-side stable	SPST-NO (1a) (Standard)	Straight PCB	<b>G6B-1114P-US</b>	5, 6, 12, 24 VDC	<b>G6B-1114P-FD-US</b>	5, 6, 12, 24 VDC	100 pcs/tray
			Self-clinching PCB	<b>G6B-1114C-US</b>	5, 6, 12, 24 VDC	<b>G6B-1114C-FD-US</b>	12, 24 VDC	
		SPST-NO (1a) (High-capacity)	Straight PCB	<b>G6B-1174P-US</b>	5, 6, 12, 24 VDC	<b>G6B-1174P-FD-US</b>	5, 6, 12, 24 VDC	20 pcs/tube
			Self-clinching PCB	<b>G6B-1174C-US</b>	5, 12, 24 VDC	<b>G6B-1174C-FD-US</b>	5, 12, 24 VDC	
		SPST-NO (1a) (High-reliability)	Straight PCB	<b>G6B-1184P-US</b>	5, 12, 24 VDC	---	---	
			Self-clinching PCB	---	---	---	---	
	Single-winding latching	SPST-NO (1a) (Standard)	Straight PCB	<b>G6BU-1114P-US</b>	5, 6, 12, 24 VDC	<b>G6BU-1114P-FD-US</b>	5, 12, 24 VDC	
			Self-clinching PCB	<b>G6BU-1114C-US</b>	12 VDC	---	---	
	Double-winding latching	SPST-NO (1a) (Standard)	Straight PCB	<b>G6BK-1114P-US</b>	5, 6, 12, 24 VDC	<b>G6BK-1114P-FD-US</b>	5, 6, 12, 24 VDC	
			Self-clinching PCB	<b>G6BK-1114C-US</b>	5, 6, 12, 24 VDC	<b>G6BK-1114C-FD-US</b>	24 VDC	
	Single-side stable	SPST-NO (1a) (Built-in high-capacity operation indicator & diode)	Straight PCB	<b>G6B-1177P-ND-US</b>	5, 12, 24 VDC	<b>G6B-1177P-FD-ND-US</b>	5, 12, 24 VDC	100 pcs/tray
			Self-clinching PCB	<b>G6B-1177C-ND-US</b>	5, 12, 24 VDC	<b>G6B-1177C-FD-ND-US</b>	12, 24 VDC	
2-pole	Single-side stable	SPST-NO (1a)+ SPST-NC (1b) (Standard)	Straight PCB	<b>G6B-2114P-US</b>	5, 6, 12, 24 VDC	<b>G6B-2114P-FD-US</b>	5, 6, 12, 24 VDC	
			Self-clinching PCB	<b>G6B-2114C-US</b>	5, 12, 24 VDC	<b>G6B-2114C-FD-US</b>	5, 12 VDC	
		DPST-NO (2a) (Standard)	Straight PCB	<b>G6B-2214P-US</b>	5, 6, 12, 24 VDC	<b>G6B-2214P-FD-US</b>	5, 6, 12, 24 VDC	
			Self-clinching PCB	<b>G6B-2214C-US</b>	5, 12, 24 VDC	<b>G6B-2214C-FD-US</b>	5, 12, 24 VDC	
		DPST-NC (2b) (Standard)	Straight PCB	<b>G6B-2014P-US</b>	5, 6, 12, 24 VDC	<b>G6B-2014P-FD-US</b>	5, 6, 12, 24 VDC	
			Self-clinching PCB	<b>G6B-2014C-US</b>	5, 6, 12, 24 VDC	<b>G6B-2014C-FD-US</b>	12, 24 VDC	

Note: AgSnIn contact models are highly welding-resistant, and roughening of contacts due to inrush current and inductive load is lessened.

### Models for Reverse Coil Polarity

Number of poles	Relay Function	Contact form	Contact material Terminals	Standard (Ag-alloy (Cd free))		AgSnIn contact		Minimum packing unit
				Model	Rated coil voltage	Model	Rated coil voltage	
1-pole	Single-side stable	SPST-NO (1a) (Standard)	Straight PCB	<b>G6B-1114P-1-US</b>	5, 6, 12, 24 VDC	<b>G6B-1114P-FD-1-US</b>	24 VDC	100 pcs/tray
			Self-clinching PCB	---	---	---	---	
		SPST-NO (1a) (High-capacity)	Straight PCB	<b>G6B-1174P-1-US</b>	5, 12, 24 VDC	---	---	20 pcs/tube
			Self-clinching PCB	---	---	---	---	
	Single-winding latching	SPST-NO (1a) (Standard)	Straight PCB	<b>G6BU-1114P-1-US</b>	5, 12 VDC	---	---	
			Self-clinching PCB	---	---	---	---	
	Double-winding latching	SPST-NO (1a) (Standard)	Straight PCB	<b>G6BK-1114P-1-US</b>	5, 6, 12, 24 VDC	---	---	
			Self-clinching PCB	---	---	---	---	
2-pole	Single-side stable	SPST-NO (1a)+ SPST-NC (1b) (Standard)	Straight PCB	<b>G6B-2114P-1-US</b>	5, 6, 12, 24 VDC	<b>G6B-2114P-FD-1-US</b>	12, 24 VDC	100 pcs/tray
			Self-clinching PCB	---	---	---	---	
		DPST-NO (2a) (Standard)	Straight PCB	<b>G6B-2214P-1-US</b>	5, 12, 24 VDC	---	---	
			Self-clinching PCB	---	---	---	---	

Note: AgSnIn contact models are highly welding-resistant, and roughening of contacts due to inrush current and inductive load is lessened.

### ● Models for Ultrasonically Cleanable

Number of poles	Relay Function	Contact form	Contact material Terminals	Standard (Ag-alloy (Cd free))		Ag3SnIn contact		Minimum packing unit
				Model	Rated coil voltage	Model	Rated coil voltage	
1-pole	Single-side stable	SPST-NO (1a) (Standard)	Straight PCB	<b>G6B-1114P-US-U</b>	5, 6, 12, 24 VDC	<b>G6B-1114P-FD-US-U</b>	6, 12, 24 VDC	100 pcs/tray
			Self-clinching PCB	<b>G6B-1114C-US-U</b>	5, 12, 24 VDC	---	---	
	Single-winding latching	SPST-NO (1a) (Standard)	Straight PCB	<b>G6BU-1114P-US-U</b>	24 VDC	---	---	
			Self-clinching PCB	---	---	---	---	
	Double-winding latching	SPST-NO (1a) (Standard)	Straight PCB	<b>G6BK-1114P-US-U</b>	5, 6, 12, 24 VDC	<b>G6BK-1114P-FD-US-U</b>	12, 24 VDC	
			Self-clinching PCB	<b>G6BK-1114C-US-U</b>	24 VDC	---	---	
2-pole	Single-side stable	SPST-NO (1a)+ SPST-NC (1b) (Standard)	Straight PCB	<b>G6B-2114P-US-U</b>	5, 12, 24 VDC	<b>G6B-2114P-FD-US-U</b>	5, 12, 24 VDC	
			Self-clinching PCB	---	---	---	---	
		DPST-NO (2a) (Standard)	Straight PCB	<b>G6B-2214P-US-U</b>	5, 6, 12, 24 VDC	<b>G6B-2214P-FD-US-U</b>	5, 12, 24 VDC	
			Self-clinching PCB	<b>G6B-2214C-US-U</b>	12, 24 VDC	---	---	
		DPST-NC (2b) (Standard)	Straight PCB	<b>G6B-2014P-US-U</b>	5, 12, 24 VDC	<b>G6B-2014P-FD-US-U</b>	5, 12, 24 VDC	
			Self-clinching PCB	---	---	---	---	

Note: When ordering, add the rated coil voltage to the model number.

Example: G6B-1114P-US DC5

— Rated coil voltage

However, the notation of the coil voltage on the product case as well as on the packing will be marked as □□ VDC.

### ● Connecting Sockets (Sold Separately)

Applicable relay	Model	Minimum ordering unit
G6B-1114P(-FD)-US-P6B G6B-1174P(-FD)-US-P6B G6B-1177P(-FD)-ND-US-P6B G6BU-1114P-US-P6B	<b>P6B-04P</b>	20 pcs
G6BK-1114P-US-P6B	<b>P6B-06P</b>	
G6B-2114P-US-P6B G6B-2214P-US-P6B G6B-2014P-US-P6B	<b>P6B-26P</b>	
Removal Tool	<b>P6B-Y1</b>	1 pcs
Hold-down Clips	<b>P6B-C2</b>	

- Note 1. G6B-1174P-US-P6B and G6B-1177P-ND-US-P6B are rated for 8 A when mounted on a PCB. However, when used with the P6B-04P socket models, the allowable current is derated to 5 A.
2. The P6B sockets are designed to be used with G6B-□□□□P(-FD)-US-P6B relays. Only use G6B relays that include "-P6B" in their model numbers with the sockets. Do not use standard G6B's that omit "-P6B" from their model numbers with the sockets.
3. The hold-down clips of the P6B-C2 model are not suitable for the G6B-1174P and G6B-1177P models since they have different heights.
4. Products with UL/CSA certification marks will be supplied for orders of standard models.

## ■ Ratings

### ● Coil: 1-Pole, Single-side Stable Type (Including models for ultrasonically cleanable)

Item Rated voltage	Rated current (mA)	Coil resistance (Ω)	Must operate voltage (V)	Must release voltage (V)	Max. voltage (V)	Power consumption (mW)
			% of rated voltage			
5 VDC	40	125	70% max.	10% min.	160% (at 23°C)	Approx. 200
6 VDC	33.3	180				
12 VDC	16.7	720				
24 VDC	8.3	2,880				

### ● Coil: 2-Pole, Single-side Stable Type (Including models for ultrasonically cleanable)

Item Rated voltage	Rated current (mA)	Coil resistance (Ω)	Must operate voltage (V)	Must release voltage (V)	Max. voltage (V)	Power consumption (mW)
			% of rated voltage			
5 VDC	60	83.3	80% max.	10% min.	140% (at 23°C)	Approx. 300
6 VDC	50	120				
12 VDC	25	480				
24 VDC	12.5	1,920				

### ● Coil: Single-winding Latching Type (Including models for ultrasonically cleanable)

Item Rated voltage	Rated current (mA)	Coil resistance (Ω)	Must set voltage (V)	Must reset voltage (V)	Max. voltage (V)	Power consumption	
			% of rated voltage			Set coil (mW)	Reset coil (mW)
5 VDC	40	125	70% max.	70% max.	160% (at 23°C)	200	200
6 VDC	33.3	180					
12 VDC	16.7	720					
24 VDC	8.3	2,880					

### ● Coil: Double-winding Latching Type (Including models for ultrasonically cleanable)

Item Rated voltage	Rated current (mA)		Coil resistance (Ω)		Must set voltage (V)	Must reset voltage (V)	Max. voltage (V)	Power consumption	
	Set coil	Reset coil	Set coil	Reset coil	% of rated voltage			Set coil (mW)	Reset coil (mW)
5 VDC	56	56	89.2	89.2	70% max.	70% max.	130% (at 23°C)	280	280
6 VDC	46.8	46.8	128.5	128.5					
12 VDC	23.3	23.3	515	515					
24 VDC	11.7	11.7	2,060	2,060					

### ● Coil: Operation Indicator Model (Flux-resistant type. Do not wash down with water.)

Item Rated voltage	Rated current (mA)	Coil resistance (Ω)	Must operate voltage (V)	Must release voltage (V)	Max. voltage (V)	Power consumption (mW)
			% of rated voltage			
5 VDC	43	116	70% max.	10% min.	130% (at 23°C)	Approx. 200
12 VDC	19.7	610				Approx. 240
24 VDC	11.3	2,120				Approx. 275

Note 1. The rated current and coil resistance are measured at a coil temperature of 23°C with a tolerance of ±10%.

2. The operating characteristics are measured at a coil temperature of 23°C.

3. The "Max. voltage" is the maximum voltage that can be applied to the relay coil.

## ● Contacts

Item	Model	Resistive load		Inductive load (cosφ = 0.4; L/R = 7 ms)		Resistive load		Inductive load (cosφ = 0.4; L/R = 7 ms)	
		Resistive load	Inductive load (cosφ = 0.4; L/R = 7 ms)	Resistive load	Inductive load (cosφ = 0.4; L/R = 7 ms)	Resistive load	Inductive load (cosφ = 0.4; L/R = 7 ms)	Resistive load	Inductive load (cosφ = 0.4; L/R = 7 ms)
Contact type	G6B-1114P(-FD)(-1)-US G6BU-1114P(-FD)(-1)-US G6BK-1114P(-FD)(-1)-US G6B-1114C(-FD)-US G6BU-1114C-US G6BK-1114C(-FD)-US	Single				Single crossbar			
Contact material		Ag-Alloy (Cd free)				Au-alloy + Ag (Cd free)			
Rated load	G6B-1174P(-FD)(-1)-US G6B-1177P(-FD)-ND-US G6B-1174C(-FD)-US G6B-1177C(-FD)-ND-US	5 A (3 A) at 250 VAC	2 A (2 A) at 250 VAC	8 A (5 A) at 250 VAC	2 A (2 A) at 250 VAC	2 A at 250 VAC	0.5 A at 250 VAC	5 A (3 A) at 250 VAC	1.5 A (1.5 A) at 250 VAC
Rated carry current		5 A (3 A) at 30 VDC	2 A (2 A) at 30 VDC	8 A (5 A) at 30 VDC	2 A (2 A) at 30 VDC	2 A at 30 VDC	0.5 A at 30 VDC	5 A (3 A) at 30 VDC	1.5 A (1.5 A) at 30 VDC
Max. switching voltage	380 VAC, 125 VDC								
Max. switching current	5 A (5 A)		8 A (5 A)		2A		5 A (5 A)		

Note 1. The values in the parentheses ( ) are for -FD models only.

2. Use the -FD type for inductive load and switching load which contact roughening is small.

## Characteristics

Model		G6B-1114P(-FD)(-1)-US G6B-1174P(-FD)(-1)-US G6B-1114C(-FD)-US G6B-1174C(-FD)-US	G6BU-1114P(-FD)(-1)-US G6BU-1114C-US	G6BK-1114P(-FD)(-1)-US G6BK-1114C(-FD)-US	G6B-1177P(-FD)-ND-US G6B-1177C(-FD)-ND-US	G6B-1184P-US	G6B-2114P(-FD)(-1)-US G6B-2214P(-FD)(-1)-US G6B-2014P(-FD)(-1)-US G6B-2114C(-FD)-US G6B-2214C(-FD)-US G6B-2014C(-FD)-US
Item	Classification	Single-side stable	Single-winding latching	Double-winding latching	Built-in operation indicator & surge absorption diode	Single-side stable	Single-side stable
Contact resistance *1		30 mΩ max.				50 mΩ max.	30 mΩ max.
Operate (set) time		10 ms max.					
Release (reset) time		10 ms max.					
Min. set pulse width		-	15 ms (at 23°C)		-		
Min. reset pulse width		-	15 ms (at 23°C)		-		
Insulation resistance *2		1,000 MΩ min.					
Dielectric strength	Between coil and contacts	3,000 VAC, 50/60 Hz for 1 min		2,000 VAC, 50/60 Hz for 1 min	3,000 VAC, 50/60 Hz for 1 min		
	Between contacts of the same polarity	1,000 VAC, 50/60 Hz for 1 min					
	Between contacts of different polarity	-					
	Between set and reset coils	-	250 VAC, 50/60 Hz for 1 min		-		
Impulse withstand voltage (between coil and contacts)		6 kV 1.2 × 50 μs	4.5 kV 1.2 × 50 μs		6 kV 1.2 × 50 μs	-	6 kV 1.2 × 50 μs
Vibration resistance	Destruction	10 to 55 to 10 Hz, 0.75 mm single amplitude (1.5 mm double amplitude)					
	Malfunction	10 to 55 to 10 Hz, 0.75 mm single amplitude (1.5 mm double amplitude)					
Shock resistance	Destruction	1,000 m/s <sup>2</sup>					
	Malfunction	100 m/s <sup>2</sup>	300 m/s <sup>2</sup>		100 m/s <sup>2</sup>		
Durability	Mechanical	50,000,000 operations min. (at 18,000 operations/hr)					
	Electrical	100,000 operation min. (at 1,800 operations/hr under rated load)					
Failure rate (P level) (reference value) *3		10 mA at 5 VDC				1 mA at 1 VDC	10 mA at 5 VDC
Ambient operating temperature		-25°C to 70°C (with no icing or condensation)					
Ambient operating humidity		5% to 85%					
Weight		Approx. 3.5 to 4.6 g	Approx. 3.5 g	Approx. 3.7 g	Approx. 5.4 g	Approx. 3.5 g	Approx. 4.5 g

Note 1. The values here are initial values.

2. The G6B-1177P(-FD)-ND model is flux-resistant. Do not wash it down with water.

\*1. The contact resistance was measured with 1 A at 5 VDC using a voltage-drop method.

\*2. Measurement conditions: The insulation resistance was measured with a 500 VDC megohmmeter at the same locations as the dielectric strength was measured. (Except the location between set/reset coil)

\*3. This value was measured at a switching frequency of 120 operations/min.

## Engineering Data

### Maximum Switching Current

G6B-1114P-US  
G6B-1174P-FD-US

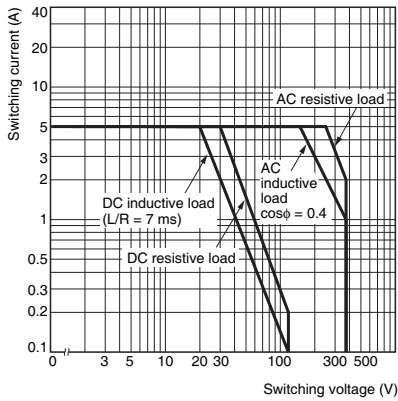

G6B-1174P-US

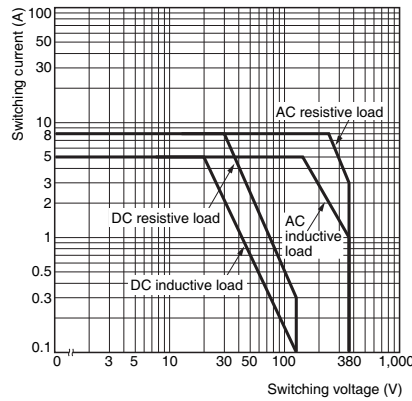

G6B-2114P-US  
G6B-2214P-US  
G6B-2014P-US

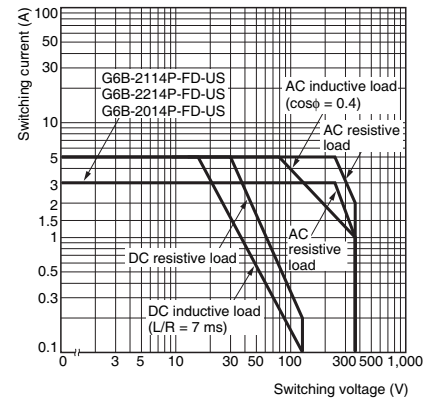

### Durability

G6B-1114P-US  
G6B-1174P-US  
G6B-1174P-FD-US

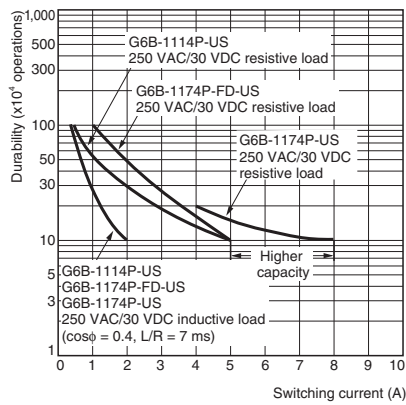

G6B-2114P(-FD)-US  
G6B-2214P(-FD)-US  
G6B-2014P(-FD)-US

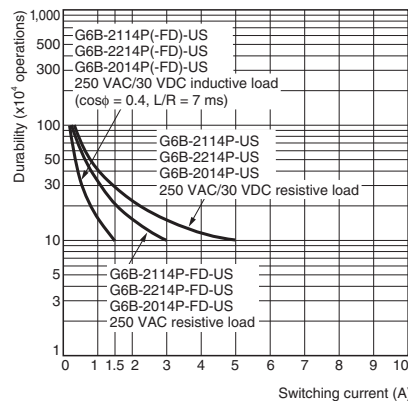

### Ambient Temperature vs. Maximum Coil Voltage

G6B-1114P-US      G6B-2114P-US  
G6B-1174P-US      G6B-2214P-US  
G6B-1174P-FD-US      G6B-2014P-US

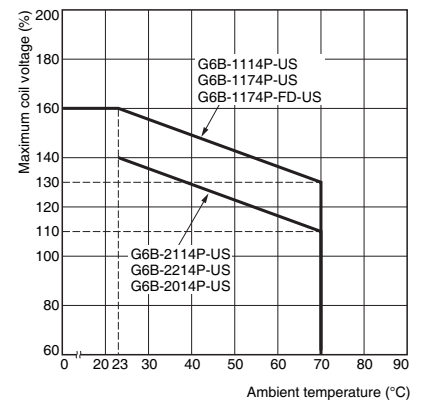

Note: The maximum coil voltage refers to the maximum value in a varying range of operating power voltage, not a continuous voltage.

### Ambient Temperature vs. Must Operate and Must Release Voltage

G6B-1114P-US

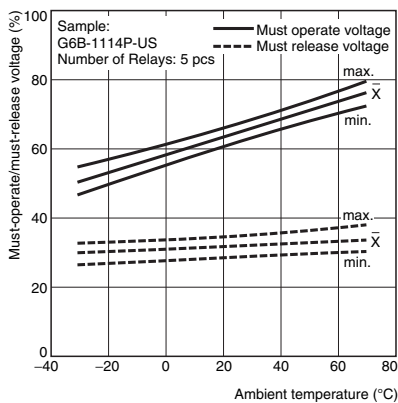

### Mutual Magnetic Interference

G6B-1114P-US

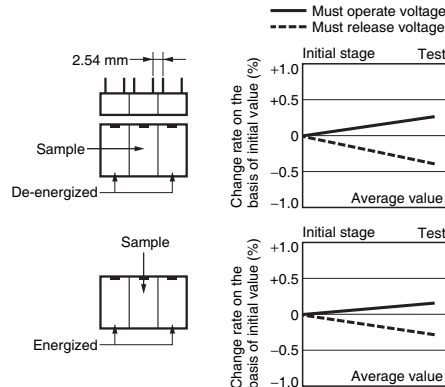

G6B-1114P-US

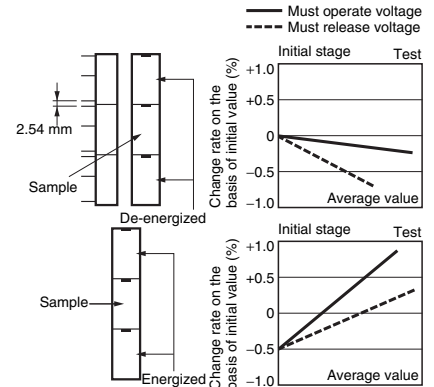

## ● Shock Malfunction

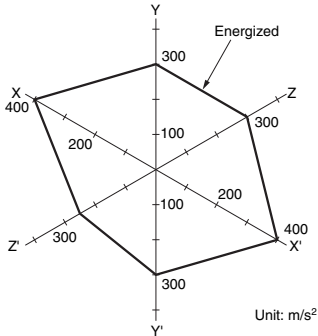

Sample: G6B-1114P-US  
 Number of Relays: 12 pcs  
 Test Conditions: Shock is applied in  $\pm X$ ,  $\pm Y$ , and  $\pm Z$  directions three times each with without energizing the Relays to check the number of malfunctions.  
 Requirement: None malfunction 100 m/s<sup>2</sup>

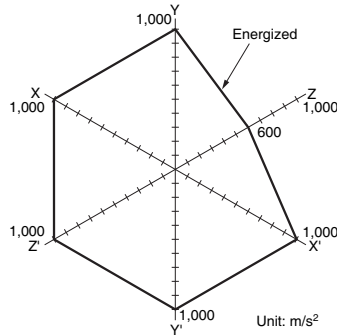
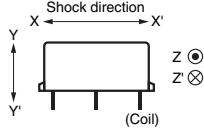

Sample: G6B-1174P-US  
 G6B-1174P-FD-US  
 Test Conditions: Shock is applied in  $\pm X$ ,  $\pm Y$ , and  $\pm Z$  directions three times each with without energizing the Relays to check the number of malfunctions.  
 Requirement: None malfunction 100 m/s<sup>2</sup>

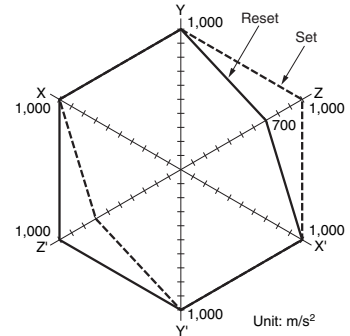
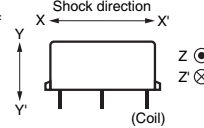

Sample: G6BK-1114P-US  
 Number of Relays: 12 pcs  
 Test Conditions: The value at which malfunction occurred was measured after applying shock to the test piece 3 times each in 6 directions along 3 axes.  
 Standard value: 300 m/s<sup>2</sup>

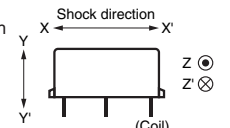

## ● Hot Start

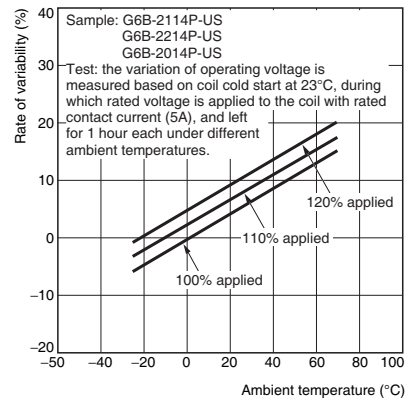
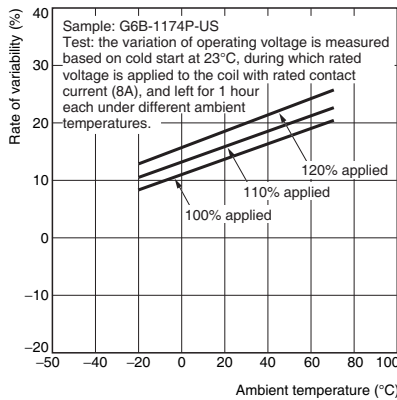
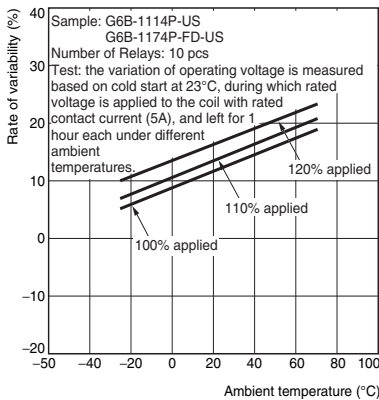

## ■ Dimensions

(Unit: mm)

### 1-pole Single-side Stable Models (SPST-NO(1a))

Straight PCB  
 G6B-1114P(-FD)(-1)-US  
 G6B-1184P-US

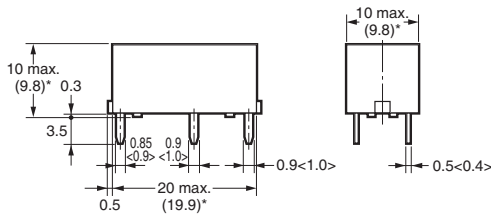
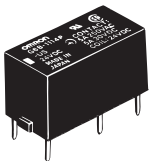

\* Average value

Dimensions in pointed brackets <> are for the Relay mounted to Socket.

PCB Mounting Holes (BOTTOM VIEW)  
 Tolerance:  $\pm 0.1$  mm

Terminal Arrangement/ Internal Connections (BOTTOM VIEW)

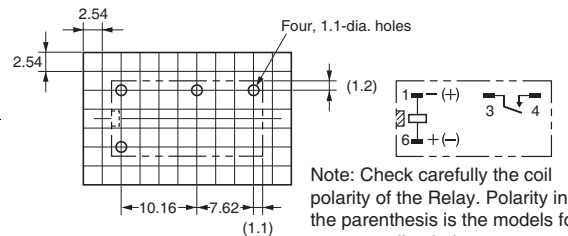

Note: Check carefully the coil polarity of the Relay. Polarity in the parenthesis is the models for reverse coil polarity.

Note: Orientation marks are indicated as follows:

### Self-clinching PCB G6B-1114C(-FD)-US

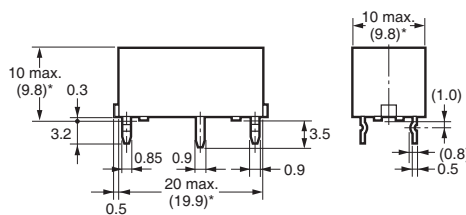
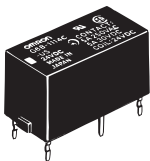

\* Average value



## 1-pole Single-side Stable Models (SPST-NO(1a))

### Straight PCB

#### G6B-1174P(-FD)(-1)-US

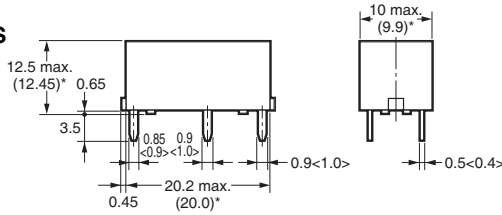
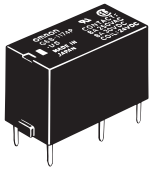

\* Average value

Dimensions in pointed brackets < > are for the Relay mounted to Socket.

### PCB Mounting Holes (BOTTOM VIEW)

Tolerance:  $\pm 0.1$  mm

### Terminal Arrangement/ Internal Connections (BOTTOM VIEW)

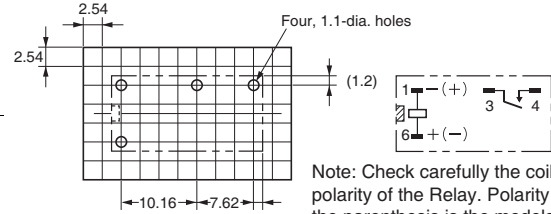

Note: Check carefully the coil polarity of the Relay. Polarity in the parenthesis is the models for reverse coil polarity.

Note: Orientation marks are indicated as follows: □ ▨

### Self-clinching PCB

#### G6B-1174C(-FD)-US

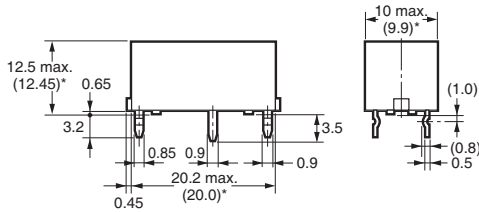
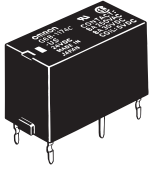

\* Average value

## 1-pole Single-winding Latching Model (SPST-NO(1a))

### Straight PCB

#### G6BU-1114P(-1)-US

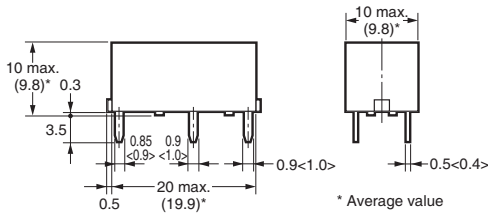
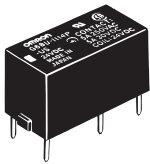

\* Average value

Dimensions in pointed brackets < > are for the Relay mounted to Socket.

### PCB Mounting Holes (BOTTOM VIEW)

Tolerance:  $\pm 0.1$  mm

### Terminal Arrangement/ Internal Connections (BOTTOM VIEW)

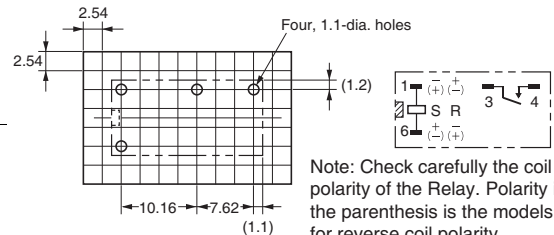

Note: Check carefully the coil polarity of the Relay. Polarity in the parenthesis is the models for reverse coil polarity.

S: Set coil  
R: Reset coil

Note: Orientation marks are indicated as follows: □ ▨

### Self-clinching PCB

#### G6BU-1114C-US

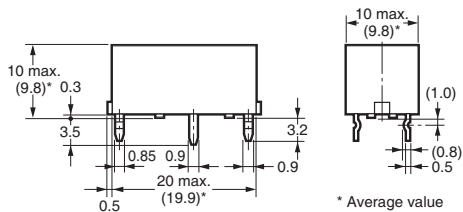
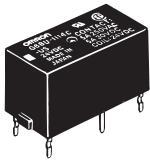

\* Average value

## 1-pole Double-winding Latching Model (SPST-NO(1a))

### Straight PCB

#### G6BK-1114P(-FD)(-1)-US

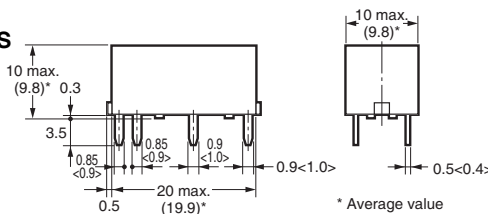
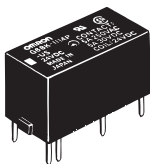

\* Average value

Dimensions in pointed brackets < > are for the Relay mounted to Socket.

### PCB Mounting Holes (BOTTOM VIEW)

Tolerance:  $\pm 0.1$  mm

### Terminal Arrangement/ Internal Connections (BOTTOM VIEW)

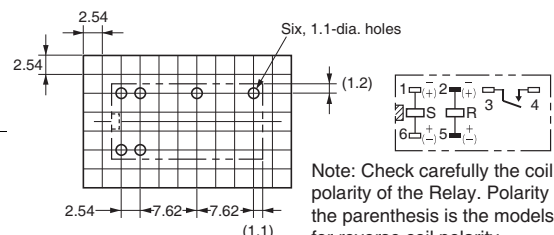

Note: Check carefully the coil polarity of the Relay. Polarity in the parenthesis is the models for reverse coil polarity.

S: Set coil  
R: Reset coil

Note: Orientation marks are indicated as follows: □ ▨

### Self-clinching PCB

#### G6BK-1114C(-FD)-US

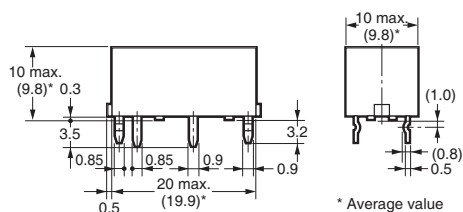
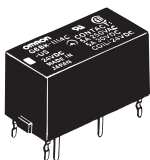

\* Average value



## 1-pole Single-side stable Models (SPST-NO (1a)) (Built-in high capacity operation indicator & surge absorption diode)

### Straight PCB

G6B-1177P(-FD)-ND-US

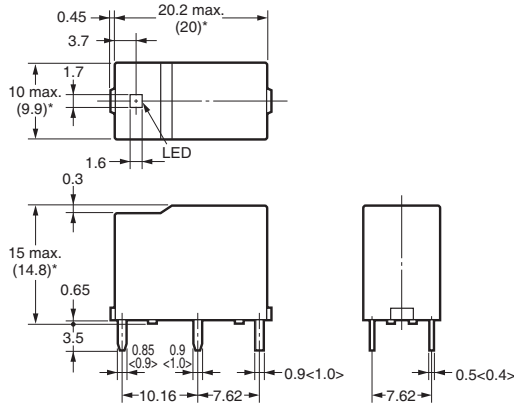
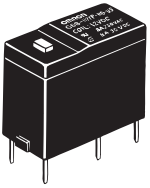

\* Average value

Dimensions in pointed brackets < > are for the Relay mounted to Socket.

**PCB Mounting Holes (BOTTOM VIEW)**  
Tolerance:  $\pm 0.1$  mm

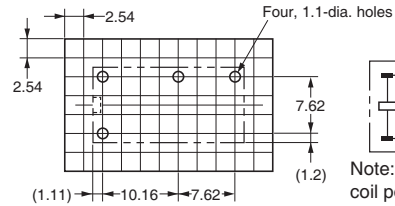

**Terminal Arrangement/ Internal Connections (BOTTOM VIEW)**

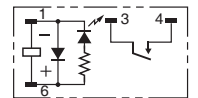

Note: Check carefully the coil polarity of the Relay.

Note: The G6B-1177P-ND-US model has a flux-resistant construction. Do not wash it down with water. Pay attention to the polarity of the coil since the LED and surge absorption diode are built-in.

### Self-clinching PCB

G6B-1177C(-FD)-ND-US

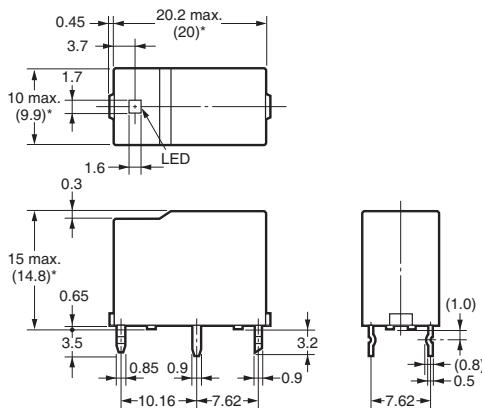
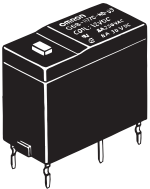

\* Average value

Dimensions in pointed brackets < > are for the Relay mounted to Socket.

## 2-poles Single-side stable Models (SPST-NO (1a) + SPST-NC (1b), DPST-NO (2a), DPST-NC(2b))

### Straight PCB

G6B-2114P(-FD)(-1)-US

G6B-2214P(-FD)(-1)-US

G6B-2014P(-FD)-US

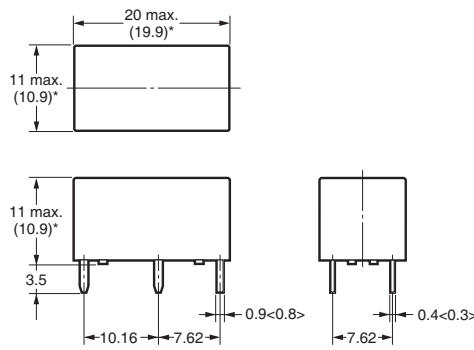
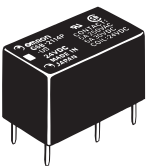

\* Average value

Dimensions in pointed brackets < > are for the Relay mounted to Socket.

**PCB Mounting Holes (BOTTOM VIEW)**  
Tolerance:  $\pm 0.1$  mm

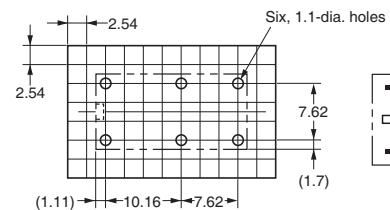

**Terminal Arrangement/ Internal Connections (BOTTOM VIEW)**

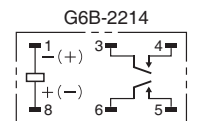
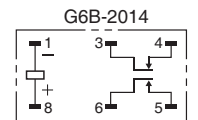
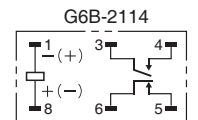

Note: Check carefully the coil polarity of the Relay. Polarity in the parenthesis is the models for reverse coil polarity.

### Self-clinching PCB

G6B-2114C(-FD)-US

G6B-2214C(-FD)-US

G6B-2014C(-FD)-US

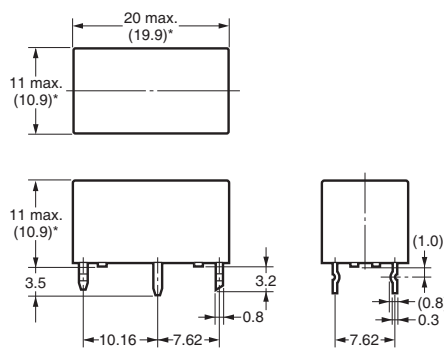
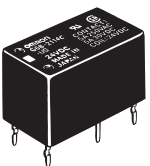

\* Average value

Dimensions in pointed brackets < > are for the Relay mounted to Socket.

## ■Connecting Sockets Dimensions

### Socket for 1-pole Single-winding Latching Model and Single-side Stable Model P6B-04P

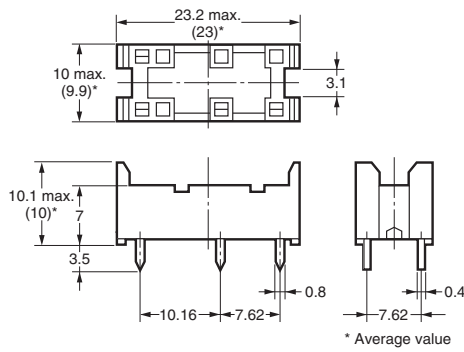
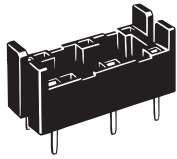

### PCB Mounting Holes (BOTTOM VIEW) Tolerance: ±0.1 mm

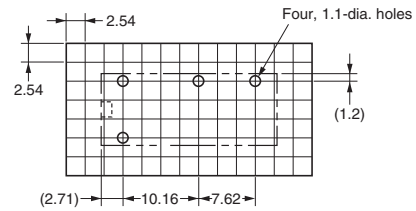

### Socket for 1-pole Double-winding Latching Model P6B-06P

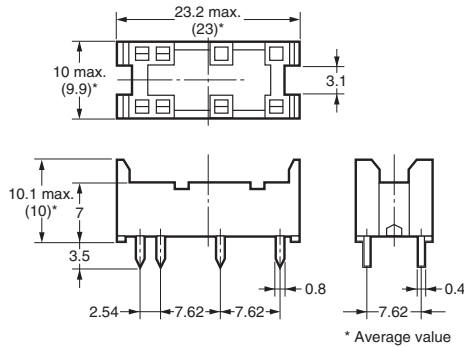
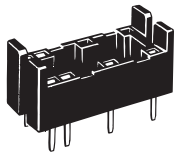

### PCB Mounting Holes (BOTTOM VIEW) Tolerance: ±0.1 mm

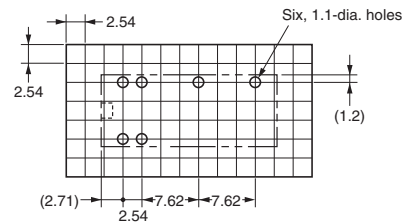

### Socket for Double-pole Single-side Stable P6B-26P

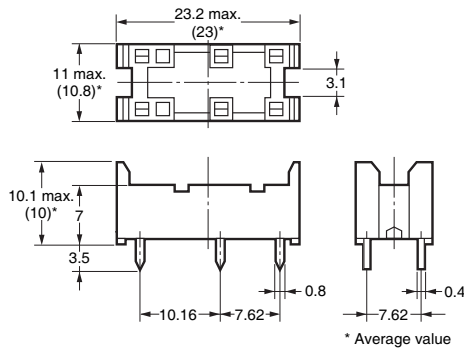
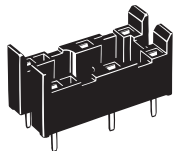

### PCB Mounting Holes (BOTTOM VIEW) Tolerance: ±0.1 mm

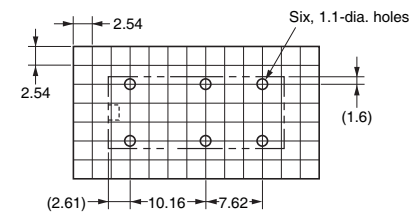

## ■Removal Tool

### P6B-Y1

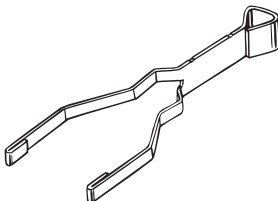

## ■Hold-down Clips

### P6B-C2

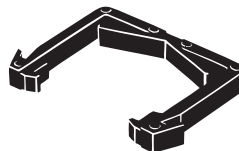

## ■Related Products

The G6B-4 Terminal Relay series with 4-point output is also available. For details, contact your OMRON sales representative.

## Approved Standards

- The approval rating values for overseas standards are different from the performance values determined individually. Confirm the values before use.

**UL Recognized:**  (File No. E41643)

Model	Contact form	Coil ratings	Contact ratings	Number of test operations
G6B-1114P(-FD)(-1)-US G6B-1114C(-FD)-US	1	3 to 24 VDC	5 A, 250 VAC (General Use) 80°C	6,000
			5 A, 30 VDC (Resistive) 80°C	
			1/8HP, 250 VAC 80°C	1,000
			1/6HP, 250 VAC 80°C	
G6B-1174P(-FD)(-1)-US G6B-1174C(-FD)-US	1	3 to 24 VDC	8 A, 277 VAC (General Use) 80°C	30,000
			8 A, 30 VDC (Resistive) 80°C	
G6B-1184P-US	1	3 to 24 VDC	2 A, 250 VAC (General Use) 80°C	6,000
			2 A, 30 VDC (Resistive) 80°C	
G6B-2114P(-FD)(-1)-US G6B-2214P(-FD)(-1)-US G6B-2014P(-FD)-US G6B-2114C(-FD)-US G6B-2214C(-FD)-US G6B-2014C(-FD)-US	2	3 to 24 VDC	5 A, 250 VAC (General Use) 80°C	6,000
			5 A, 30 VDC (Resistive) 80°C	

**CSA Certified:**  (File No. LR31928)

Model	Contact form	Coil ratings	Contact ratings	Number of test operations
G6B-1114P(-FD)(-1)-US G6B-1114C(-FD)-US	1	3 to 24 VDC	5 A, 250 VAC (General Use) 80°C	6,000
			5 A, 30 VDC (Resistive) 80°C	
			1/6HP, 250 VAC 80°C	1,000
			360 W, 120 VAC tungsten 80°C	6,000
G6B-1174P(-FD)(-1)-US G6B-1174C(-FD)-US	1	3 to 24 VDC	8 A, 277 VAC (General Use) 80°C	30,000
			8 A, 30 VDC (Resistive) 80°C	
G6B-2114P(-FD)(-1)-US G6B-2214P(-FD)(-1)-US G6B-2014P(-FD)-US G6B-2114C(-FD)-US G6B-2214C(-FD)-US G6B-2014C(-FD)-US	2	3 to 24 VDC	5 A, 250 VAC (General Use) 80°C	6,000
			5 A, 30 VDC (Resistive) 80°C	

**EN/IEC, TÜV Certified:**  (Registration No. R50158246)

Model	Contact form	Coil ratings	Contact ratings	Number of test operations
G6B-1114P(-1)-US G6B-1114C-US	1	5, 6, 12, 24 VDC	5 A, 250 VAC (cosφ = 1) at 70°C	20,000
			2 A, 250 VAC (cosφ = 0.4) at 70°C	
			5 A, 30 VDC (L/R = 0 ms) at 70°C	
G6B-1174P(-1)-US G6B-1174C-US	1	5, 6, 12, 24 VDC	8 A, 250 VAC (cosφ = 1) at 70°C	
			2 A, 250 VAC (cosφ = 0.4) at 70°C	
			8 A, 30 VDC (L/R = 0 ms) at 70°C	
G6B-2114P(-1)-US G6B-2214P(-1)-US G6B-2014P-US G6B-2114C-US G6B-2214C-US G6B-2014C-US	2	5, 6, 12, 24 VDC	5 A, 250 VAC (cosφ = 1) at 70°C	
			1.5 A, 250 VAC (cosφ = 0.4) at 70°C	
			5 A, 30 VDC (L/R = 0 ms) at 70°C	
G6B-1114P(-FD)(-1)-US G6B-1114C(-FD)-US	1	5, 6, 12, 24 VDC	3 A, 250 VAC (cosφ = 1) at 70°C	10,000
			3 A, 30 VDC (L/R = 0 ms) at 70°C	
G6B-1174P(-FD)(-1)-US G6B-1174C(-FD)-US	1	5, 6, 12, 24 VDC	5 A, 250 VAC (cosφ = 1) at 70°C	
			2 A, 250 VAC (cosφ = 0.4) at 70°C	
			5 A, 30 VDC (L/R = 0 ms) at 70°C	
G6B-2114P(-FD)(-1)-US G6B-2214P(-FD)(-1)-US G6B-2014P(-FD)-US G6B-2114C(-FD)-US G6B-2214C(-FD)-US G6B-2014C(-FD)-US	2	5, 6, 12, 24 VDC	1.5 A, 250 VAC (cosφ = 0.4) at 70°C	
			3 A, 30 VDC (L/R = 0 ms) at 70°C	

## ■Precautions

● Please refer to “PCB Relays Common Precautions” for correct use.

### Correct Use

#### ● Mounting

- When installing more than two Relays side by side on a PCB, keep the gaps as shown below.

It may cause a malfunction if heat is not dissipated smoothly from the Relay.

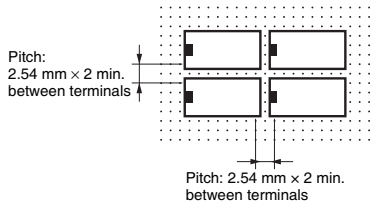

- No specified mounting direction.

#### ● Mounting Height of Sockets and Precautions



- Hold-down clips (for mounting and removal) are also available. (For P6B-C2 model) However, it is not suitable for G6B-1174P and G6B-1177P models.
- Removal tool is also available. (For P6B-Y1 model) However, it is not suitable for G6B-1177P model.

#### ● Inhibit Circuit of the G6B-1177P(-FD)-ND-US Model

- Do not use under conditions in which a surge is included in the power supply, such as when an inductive load is connected in parallel to the coil. Doing so will cause damage to the installed (or built-in) coil surge absorbing diode.

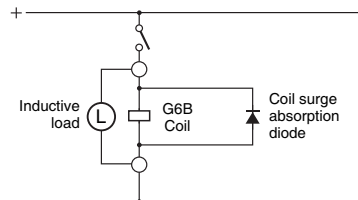

#### ● Using SPDT contact of the SPST-NO+SPST-NC Relay

- Do not construct a circuit so that overcurrent and burning occur if the NO, NC and SPDT contacts are short-circuited with the SPST-NO+SPST-NC Relay. Arcing may generate short-circuiting between contacts if there is short-circuiting because of conversion to the MBB contact caused by asynchronous operation of the NO and NC contacts, the interval between the NO and NC contacts is small, or a large current is left open.

#### ● Other precautions

- The P6B model has a flux-resistant construction. Do not wash it down with water.
- Perform wiring of No.1 and No. 2 of the X terminal as COM for double-winding latching as shown below. The operation stability improves by doing this.

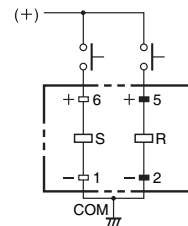

- Check carefully the coil polarity (+ and -) of the Relay G6B-1177P(-FD)-ND-US. Do not reverse the polarity when connecting. Otherwise the built-in coil surge absorption diode may be damaged.
- This Relay is a Power Relay which is suitable for power load switching. Do not use the G6B for signal purposes such as micro load switching under 10 mA.

Please check each region's Terms & Conditions by region website.

## OMRON Corporation

### Device & Module Solutions Company

#### Regional Contact

##### Americas

<https://components.omron.com/us>

##### Asia-Pacific

<https://components.omron.com/ap>

##### Korea

<https://components.omron.com/kr>

##### Europe

<https://components.omron.com/eu>

##### China

<https://components.omron.com.cn>

##### Japan

<https://components.omron.com/jp>