



TAI-SAW TECHNOLOGY CO., LTD.

No. 3, Industrial 2nd Rd., Ping-Chen Industrial District,
Taoyuan, 324, Taiwan, R.O.C.

TEL: 886-3-4690038 FAX: 886-3-4697532

E-mail: tstsales@mail.taisaw.com Web: www.taisaw.com

Product Specifications Approval Sheet

Product Description: SAW Filter 3450 MHz SMD 3.0x3.0 mm (BW=98.28 MHz)

TST Part No.: TA2544A

Customer Part No.: _____

Customer signature required
Company: _____
Division: _____
Approved by : _____
Date: _____

Checked by: _____ David Chang *David*

Approved by: _____ Andy Yu *Andy Yu*

Date: _____ 2019/05/20

1. Customer signed back is required before TST can proceed with sample build and receive orders.
2. Orders received without customer signed back will be regarded as agreement on the specifications.
3. Any specifications changes must be approved upon by both parties and a new revision of specifications shall be released to reflect the changes.



TAI-SAW TECHNOLOGY CO., LTD.

No. 3, Industrial 2nd Rd., Ping-Chen Industrial District,
Taoyuan, 324, Taiwan, R.O.C.

TEL: 886-3-4690038 FAX: 886-3-4697532

E-mail: tstsales@mail.taisaw.com Web: www.taisaw.com

SAW Filter 3450 MHz

MODEL NO.: TA2544A

REV. NO.:1

A. MAXIMUM RATING:

1. Input Power Level: 20 dB_m
2. DC voltage: 3 V
3. Operating Temperature: -40°C to +85°C
4. Storage Temperature: -40°C to +85°C
5. Moisture Sensitivity Level: Level 1 (MSL1)

RoHS Compliant
Lead free
Lead-free soldering

Electrostatic Sensitive Device (ESD)

B. ELECTRICAL CHARACTERISTICS:

Item	Unit	Min.	Typ.	Max.
Center frequency F_c	MHz	-	3450	-
Insertion Loss (3400.86~3499.14 MHz) IL	dB	-	3.9	5.2
Amplitude Ripple (3400.86~3499.14 MHz)	dB _{p-p}	-	1.7	3.0
Attenuation (Reference level from 0 dB)				
3260 MHz	dB	30	41	-
3295 MHz	dB	25	33	-
3380 MHz	dB	2.5	4.5	-
3520 MHz	dB	2.5	5	-
3575 MHz	dB	25	43	-
Temperature Coefficient of Frequency	ppm/°C	-	-36	-

C. MEASUREMENT CIRCUIT:

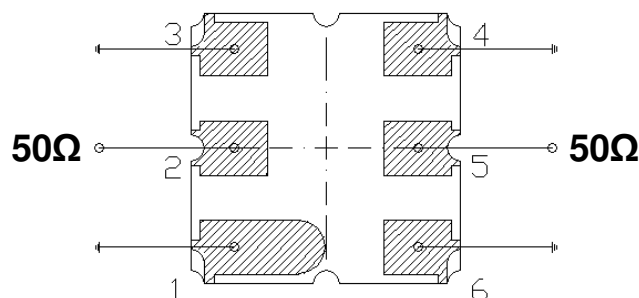

(2): Unbalance Port

(5): Unbalance Port

Others: Ground

D. OUTLINE DRAWING:

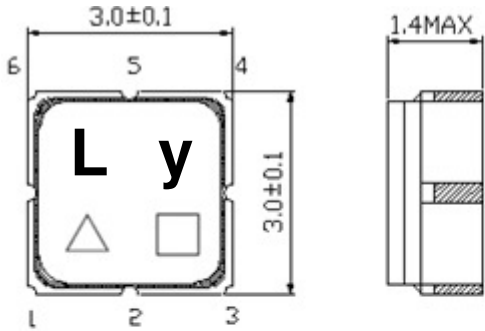

Unit : mm

Not Specified Tolerance : +/-0.15 mm

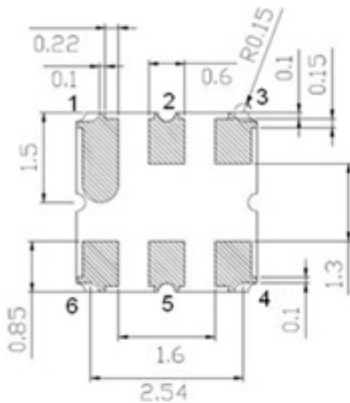
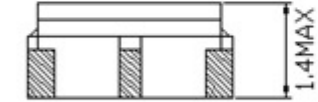

Pin No.	Symbol	Function
1	GND	Ground
2	IN	Input
3	GND	Ground
4	GND	Ground
5	OUT	Output
6	GND	Ground

△ : Year Code (2011->1, 2012->2, ..., 2019->9, 2020->0)

□ : Date Code

Date Code Table:

WK01	WK02	WK03	WK04	WK05	WK06	WK07	WK08	WK09	WK10	WK11	WK12	WK13
A	B	C	D	E	F	G	H	I	J	K	L	M
WK14	WK15	WK16	WK17	WK18	WK19	WK20	WK21	WK22	WK23	WK24	WK25	WK26
N	O	P	Q	R	S	T	U	V	W	X	Y	Z
WK27	WK28	WK29	WK30	WK31	WK32	WK33	WK34	WK35	WK36	WK37	WK38	WK39
a	b	c	d	e	f	g	h	i	j	k	l	m
WK40	WK41	WK42	WK43	WK44	WK45	WK46	WK47	WK48	WK49	WK50	WK51	WK52
n	o	p	q	r	s	t	u	v	w	x	y	z

E. PCB Footprint:

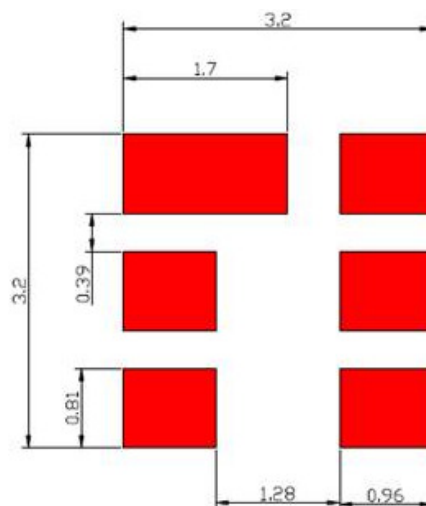

TAI-SAW TECHNOLOGY CO., LTD.

TST DCC
Release document

F. Frequency Characteristics:

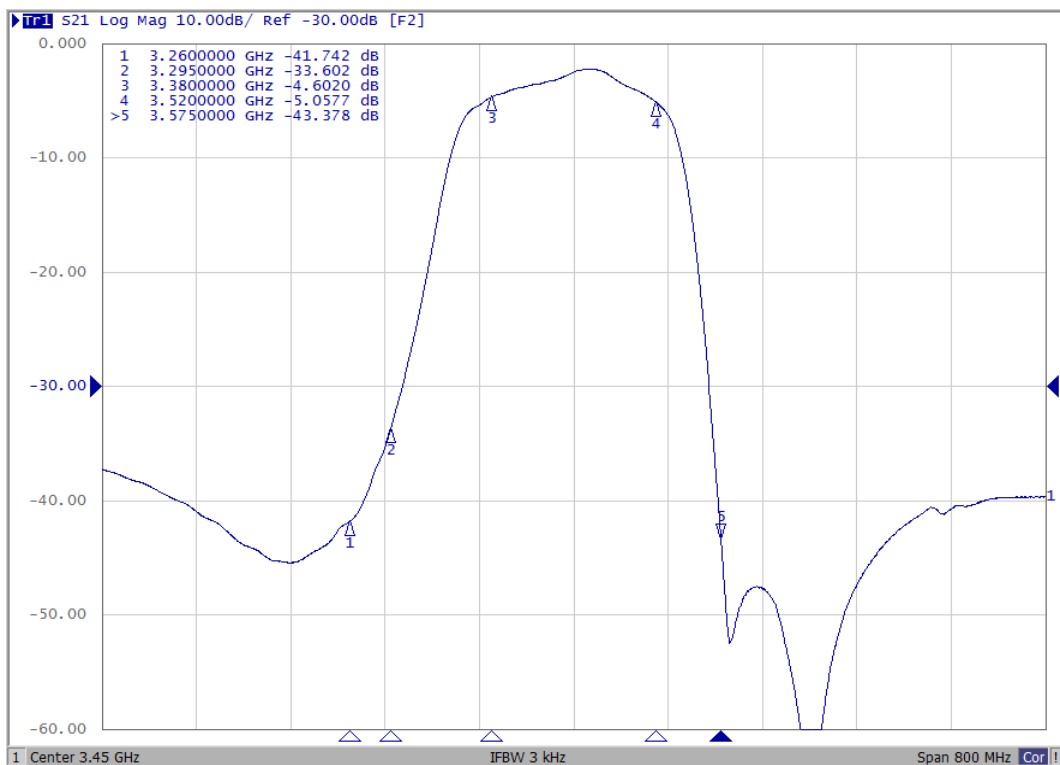
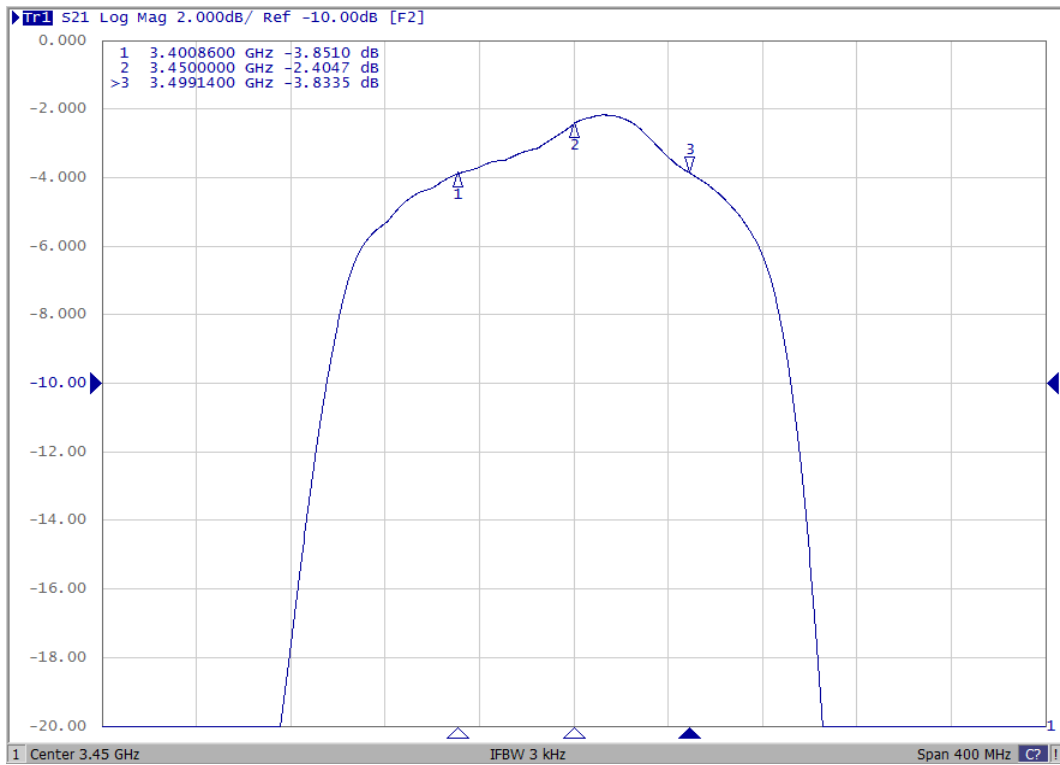

G. PACKING:

1. REEL DIMENSION

(Please refer to FR-75D10 for packing quantity)

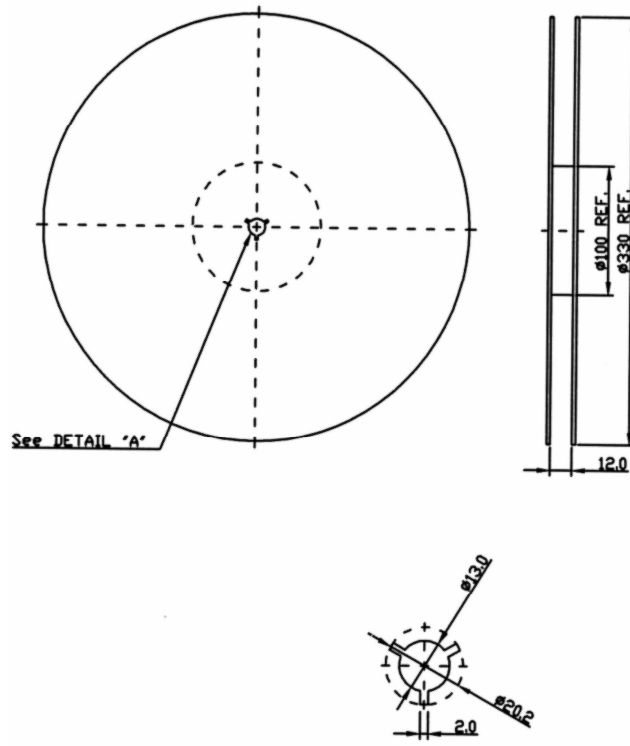

2. TAPE DIMENSION

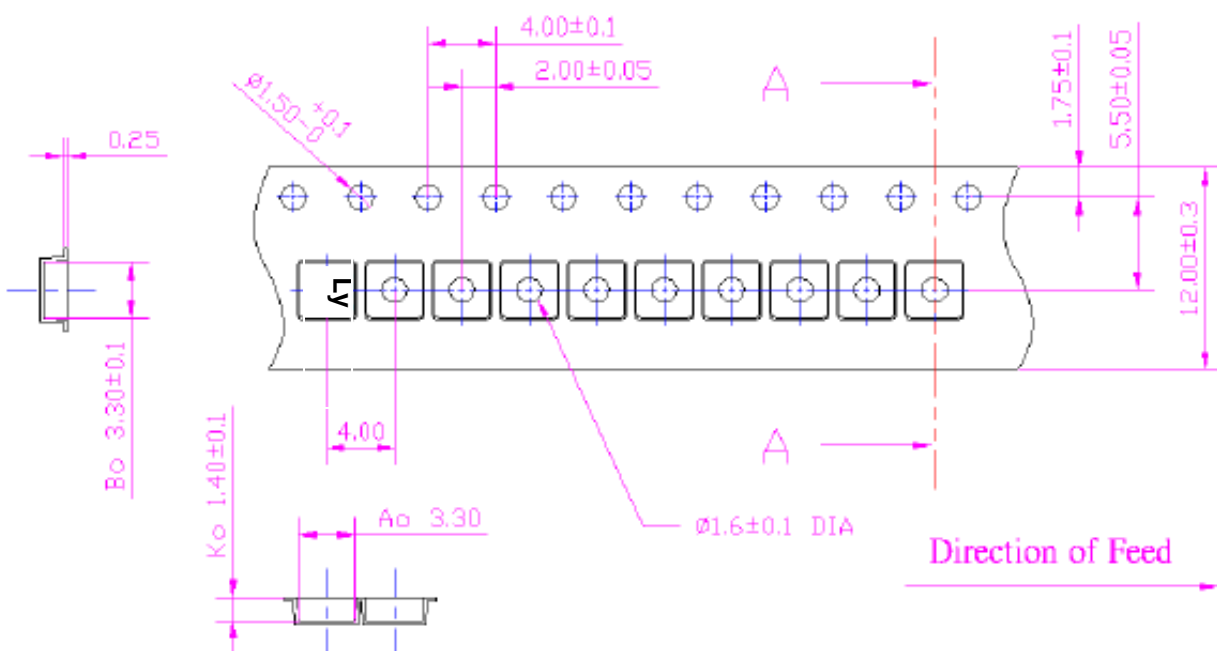

H. Recommended Reflow Profile:

1. Preheating shall be fixed at 150~180°C for 60~90 seconds.
2. Ascending time to preheating temperature 150°C shall be 30 seconds min.
3. Heating shall be fixed at 220°C for 50~80 seconds and at 260°C+0/-5°C peak (20~40sec).
4. Time: 2 times.

