

CATIA V5

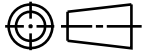

Revision Level			Revision Record	Changed	Date	Approved	Date
Drawing	State	Part					
00.0	Design Release	-	SEE ECN# 014970	JMC	03/22/19	EJH	03/22/19

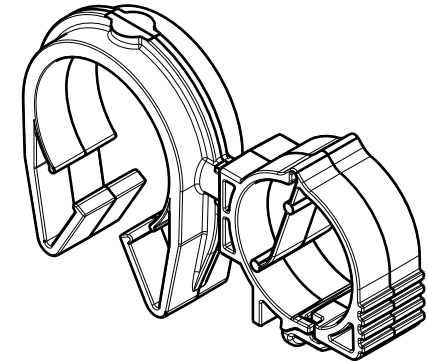

ISOMETRIC VIEW
CLOSED

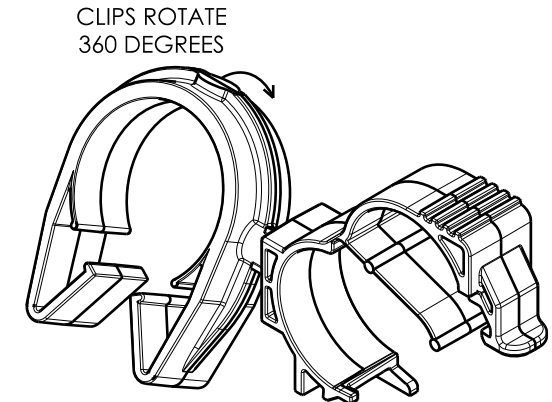
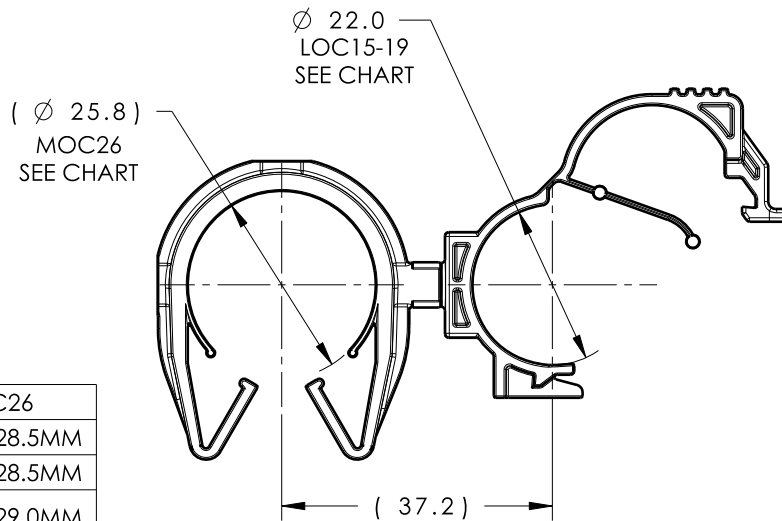

CLIPS ROTATE
360 DEGREES

ISOMETRIC VIEW
OPEN

TYPE	MOC26
HARNESS	23.0MM-28.5MM
HOSE	23.0MM-28.5MM
HARD PIPE/TUBE	25.9MM-29.0MM

*RECOMMENDED SIZES MAY DIFFER DEPENDING ON THE APPLICATION, PRODUCT, REQUIRMENTS AND MATERIALS USED

**PATENT PENDING 29/582,271

GLOBAL PART DESCRIPTION	MOC26**			LOC15-19		
	DRAWING	MATERIAL	COLOR	DRAWING	MATERIAL	COLOR
MOC26FLOC15-19-PA66HIRHSUV-BK	16-0325-001-CSU	PA66HIRHSUV	BLACK	12-0429-051-CSU	PA66HIRHSUV	BLACK

Material SEE CHART COLOR: SEE CHART	Units	millimeters	The copyright of this drawing is reserved by HellermannTyton. It is issued on condition that it is not reproduced, copied or disclosed to a third party, either wholly or in part, without the consent of HellermannTyton.	Drawn	JMC	03/22/19	Article/Type-No MOC26FLOC15-19	Scale	1:1	
	Tolerance defined on each dimension	Approved		EJH	03/22/19	Title 26MM MOC COUPLED TO 15-19MM LOC		Project Number	16-0327	
		<p>North America Email: corp@htamericas.com Web: www.hellermann.tyton.com</p>			Drawing-No		PRODUCTION : Phase	Format	AH	
					16-0327-263-CSU		Sheet	1/1		