

Data sheet | Item number: 2003-7650

Multilevel installation terminal block; with operating slots; 2.5 mm²; L; Push-in
CAGE CLAMP®; 2,50 mm²; gray

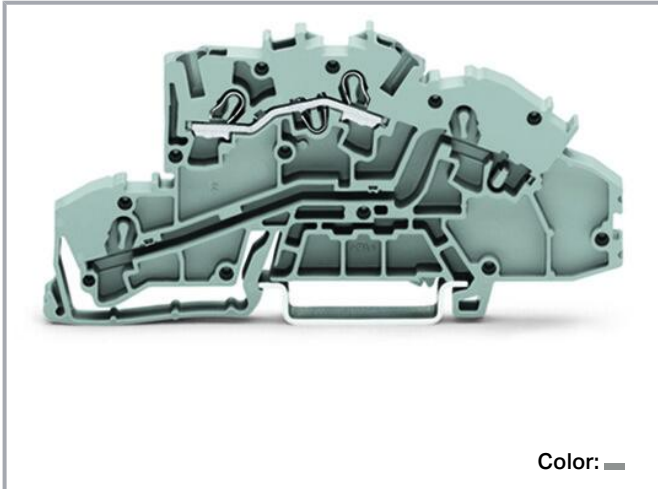

www.wago.com/2003-7650



Color: —

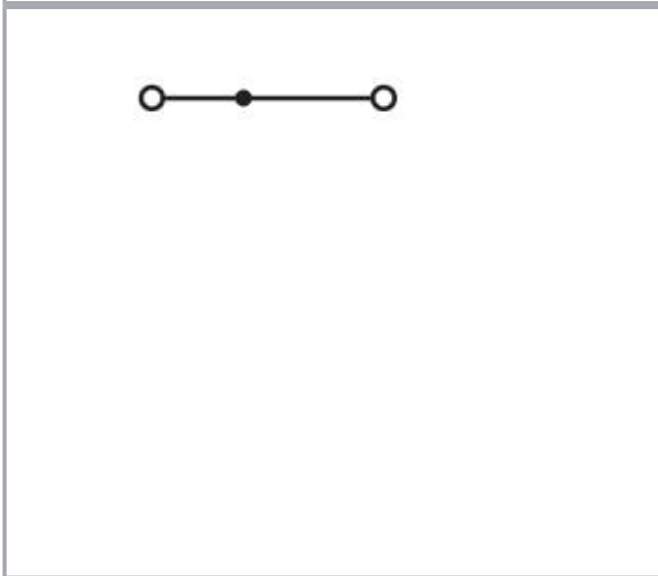
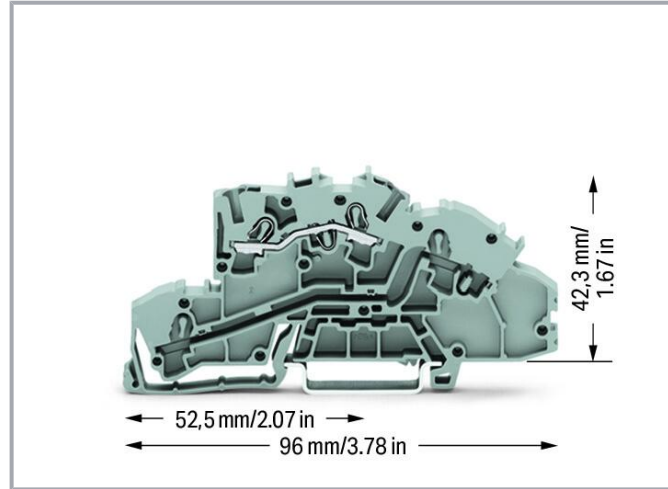

Data

Electrical data

Ratings per IEC/EN

Ratings per	IEC/EN 60947-7-1
Nominal voltage (III/3)	400 V

Subject to changes. Please also observe the further product documentation!

WAGO GmbH & Co. KG
Hansastr. 27
32423 Minden
Phone: +49571 887-0 | Fax: +49571 887-169
Email: info.de@wago.com | Web: www.wago.com

Do you have any questions about our products?
We are always happy to take your call at +49 (571) 887-44222.



Rated impulse voltage (III/3)	6 kV
Rated current	24 A
Current at conductor cross-section (max.) mm ²	32 A
Legend (ratings)	(III / 3) \triangleq Overvoltage category III / Pollution degree 3

Power loss

Power loss, per pole (potential)	0.766 W
Rated current I_N for specified power loss	24 A
Resistance value for specified, current-dependent power loss	0.001 Ω

Connection data

Connection points	2
Total number of potentials	1
Number of levels	3

Connection 1

Connection technology	Push-in CAGE CLAMP [®]
Actuation type	Operating tool
Connectable conductor materials	Copper
Nominal cross-section	2.5 mm ²
Solid conductor	0.25 ... 4 mm ² / 22 ... 12 AWG
Solid conductor; push-in termination	0.75 ... 4 mm ² / 18 ... 12 AWG
Fine-stranded conductor	0.25 ... 4 mm ² / 22 ... 12 AWG
Fine-stranded conductor; with insulated ferrule	0.25 ... 2.5 mm ² / 22 ... 14 AWG
Fine-stranded conductor; with ferrule; push-in termination	1 ... 2.5 mm ² / 18 ... 14 AWG
Note (conductor cross-section)	Depending on the conductor characteristic, a conductor with a smaller cross-section can also be inserted via push-in termination.
Strip length	10 ... 12 mm / 0.39 ... 0.47 inches
Wiring direction	Front-entry wiring

Physical data

Width	5.2 mm / 0.205 inches
Height	96 mm / 3.78 inches
Depth from upper-edge of DIN-rail	42.3 mm / 1.665 inches

Subject to changes. Please also observe the further product documentation!

WAGO GmbH & Co. KG
 Hansastr. 27
 32423 Minden
 Phone: +49571 887-0 | Fax: +49571 887-169
 Email: info.de@wago.com | Web: www.wago.com

Do you have any questions about our products?
 We are always happy to take your call at +49 (571) 887-44222.



Mechanical Data

Potential marking	L
Mounting type	DIN-35 rail
Marking level	Center/side marking

Material Data

Note (material data)

Information on material specifications can be found here

Color	gray
Material group	I
Insulation material	Polyamide (PA66)
Flammability class per UL94	V0
Fire load	0.241 MJ
Weight	9.8 g

Environmental requirements

Processing temperature	-35 ... +85 °C
Continuous operating temperature	-60 ... +105 °C

Commercial data

Product Group	22 (TOPJOB S)
eCl@ss 10.0	27-14-11-25
eCl@ss 9.0	27-14-11-25
ETIM 8.0	EC001329
ETIM 7.0	EC001329
PU (SPU)	50 pcs
Packaging type	box
Country of origin	DE
GTIN	4045454735944
Customs tariff number	85369010000

Environmental Product Compliance

RoHS Compliance Status	Compliant, No Exemption
------------------------	-------------------------



Subject to changes. Please also observe the further product documentation!

WAGO GmbH & Co. KG
 Hansastr. 27
 32423 Minden
 Phone: +49571 887-0 | Fax: +49571 887-169
 Email: info.de@wago.com | Web: www.wago.com



Do you have any questions about our products?
 We are always happy to take your call at +49 (571) 887-44222.

Approvals / Certificates

General approvals

Logo	Approval	Additional Approval Text	Certificate name
	CCA DEKRA Certification B.V.	EN 60947	71- 113530
	CCA DEKRA Certification B.V.	EN 60947	NTR NL- 7828

Declarations of conformity and manufacturer's declarations

Logo	Approval	Additional Approval Text	Certificate name
	EU-Declaration of Conformity WAGO GmbH & Co. KG	-	-
	UK-Declaration of Conformity WAGO GmbH & Co. KG	-	-

Required accessories

End plate

End plate



Item no.: 2003-7692

End and intermediate plate; 0.8 mm thick; orange

www.wago.com/2003-7692

Optional accessories

Testing and measuring

Testing accessories



Item no.: 2009-174

Test plug adapter; for 4 mm Ø test plugs; for testing TOPJOB®S rail-mounted terminal blocks; gray

www.wago.com/2009-174



Item no.: 2009-182

Testing tap; for max. 2.5 mm²; tool-free connection for individual test wires 0.08 - 2.5 mm; gray

www.wago.com/2009-182

Subject to changes. Please also observe the further product documentation!

WAGO GmbH & Co. KG

Hansastr. 27

32423 Minden

Phone: +49571 887-0 | Fax: +49571 887-169

Email: info.de@wago.com | Web: www.wago.com

Do you have any questions about our products?

We are always happy to take your call at +49 (571) 887-44222.



Item no.: 210-136
Test plug; 2 mm Ø; with 500 mm cable; red

www.wago.com/210-136

Tool

Operating tool



Item no.: 2009-310
Operating tool; Blades: 3.5 x 0.5 mm and 5.5 x 0.8 mm; for TOPJOB®S installation terminal blocks; green www.wago.com/2009-310



Item no.: 2009-309
Operating tool; Blades: 3.5 x 0.5 mm and 2.5 x 0.4 mm; for TOPJOB®S installation terminal blocks www.wago.com/2009-309



Item no.: 210-658
Operating tool; Blade: 3.5 x 0.5 mm; with a partially insulated shaft; angled; short; multicoloured www.wago.com/210-658



Item no.: 210-720
Operating tool; Blade: 3.5 x 0.5 mm; with a partially insulated shaft; multicoloured www.wago.com/210-720

Jumpers

Jumper



Item no.: 210-123
Wire commoning chain; insulated; blue www.wago.com/210-123



Item no.: 2002-402
Jumper; 2-way; insulated; light gray www.wago.com/2002-402



Item no.: 2002-402/000-005
Jumper; 2-way; insulated; red www.wago.com/2002-402/000-005



Item no.: 2002-400
Continuous jumper; 2-way; insulated; light gray www.wago.com/2002-400



Item no.: 2002-403
Jumper; 3-way; insulated; light gray www.wago.com/2002-403



Item no.: 2002-404/000-005
Jumper; 4-way; insulated; red www.wago.com/2002-404/000-005















Item no.: 2002-403/000-006
Jumper; 3-way; insulated; blue www.wago.com/2002-403/000-006



Item no.: 2002-404/000-006
Jumper; 4-way; insulated; blue www.wago.com/2002-404/000-006

Subject to changes. Please also observe the further product documentation!

	Item no.: 2002-403/000-005 Jumper; 3-way; insulated; red	www.wago.com/2002-403/000-005
	Item no.: 2002-405/000-005 Jumper; 5-way; insulated; red	www.wago.com/2002-405/000-005
	Item no.: 2002-402/000-006 Jumper; 2-way; insulated; blue	www.wago.com/2002-402/000-006
	Item no.: 2002-405/000-006 Jumper; 5-way; insulated; blue	www.wago.com/2002-405/000-006
	Item no.: 2002-404 Jumper; 4-way; insulated; light gray	www.wago.com/2002-404
	Item no.: 2002-406/000-006 Jumper; 6-way; insulated; blue	www.wago.com/2002-406/000-006
	Item no.: 2002-406/000-005 Jumper; 6-way; insulated; red	www.wago.com/2002-406/000-005
	Item no.: 2002-406/020-000 Delta jumper; insulated; light gray	www.wago.com/2002-406/020-000
	Item no.: 2002-405 Jumper; 5-way; insulated; light gray	www.wago.com/2002-405
	Item no.: 2002-407/000-005 Jumper; 7-way; insulated; red	www.wago.com/2002-407/000-005
	Item no.: 2002-408 Jumper; 8-way; insulated; light gray	www.wago.com/2002-408
	Item no.: 2002-408/000-006 Jumper; 8-way; insulated; blue	www.wago.com/2002-408/000-006

Subject to changes. Please also observe the further product documentation!

Item no.: 2002-405/011-000
Star point jumper; 3-way; insulated; light gray

www.wago.com/2002-405/011-000



Item no.: 2002-407/000-006
Jumper; 7-way; insulated; blue

www.wago.com/2002-407/000-006



Item no.: 2002-408/000-005
Jumper; 8-way; insulated; red

www.wago.com/2002-408/000-005



Item no.: 2002-407
Jumper; 7-way; insulated; light gray

www.wago.com/2002-407



Item no.: 2002-406
Jumper; 6-way; insulated; light gray

www.wago.com/2002-406



Item no.: 2002-410/000-005
Jumper; 10-way; insulated; red

www.wago.com/2002-410/000-005



Item no.: 2002-410/000-006
Jumper; 10-way; insulated; blue

www.wago.com/2002-410/000-006



Item no.: 2002-410
Jumper; 10-way; insulated; light gray

www.wago.com/2002-410



Item no.: 2002-409/000-006
Jumper; 9-way; insulated; blue

www.wago.com/2002-409/000-006



Item no.: 2002-409/000-005
Jumper; 9-way; insulated; red

www.wago.com/2002-409/000-005



Item no.: 2002-409
Jumper; 9-way; insulated; light gray

www.wago.com/2002-409



Item no.: 2002-423/000-006
Continuous jumper; from 1 to 3; insulated; blue

















www.wago.com/2002-423/000-006













Item no.: 2002-423
Continuous jumper; from 1 to 3; insulated; light gray

www.wago.com/2002-423

Subject to changes. Please also observe the further product documentation!

	Item no.: 2002-433 Jumper; from 1 to 3; insulated; light gray	www.wago.com/2002-433
	Item no.: 2002-434 Jumper; from 1 to 4; insulated; light gray	www.wago.com/2002-434
	Item no.: 2002-423/000-005 Continuous jumper; from 1 to 3; insulated; red	www.wago.com/2002-423/000-005
	Item no.: 2002-435 Jumper; from 1 to 5; insulated; light gray	www.wago.com/2002-435
	Item no.: 2002-436 Jumper; from 1 to 6; insulated; light gray	www.wago.com/2002-436
	Item no.: 2002-437 Jumper; from 1 to 7; insulated; light gray	www.wago.com/2002-437
	Item no.: 2002-438 Jumper; from 1 to 8; insulated; light gray	www.wago.com/2002-438
	Item no.: 2002-439 Jumper; from 1 to 9; insulated; light gray	www.wago.com/2002-439
	Item no.: 2002-440 Jumper; from 1 to 10; insulated; light gray	www.wago.com/2002-440
	Item no.: 2002-472 Staggered jumper; 2-way; insulated; light gray	www.wago.com/2002-472
	Item no.: 2002-473 Staggered jumper; 3-way; insulated; light gray	www.wago.com/2002-473
	Item no.: 2002-475/011-000 Staggered jumper; 3-way; insulated; light gray	www.wago.com/2002-475/011-000
	Item no.: 2002-475 Staggered jumper; 5-way; insulated; light gray	www.wago.com/2002-475
	Item no.: 2002-476 Staggered jumper; 6-way; insulated; light gray	www.wago.com/2002-476
	Item no.: 2002-474 Staggered jumper; 4-way; insulated; light gray	www.wago.com/2002-474
	Item no.: 2002-477 Staggered jumper; 7-way; insulated; light gray	www.wago.com/2002-477
	Item no.: 2002-473/011-000 Staggered jumper; 2-way; from 1 to 3; insulated; light gray	www.wago.com/2002-473/011-000

Subject to changes. Please also observe the further product documentation!

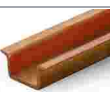
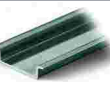
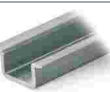
	Item no.: 2002-479 Staggered jumper; 9-way; insulated; light gray	www.wago.com/2002-479
	Item no.: 2002-478 Staggered jumper; 8-way; insulated; light gray	www.wago.com/2002-478
	Item no.: 2002-479/011-000 Staggered jumper; insulated; light gray	www.wago.com/2002-479/011-000
	Item no.: 2002-480 Staggered jumper; 10-way; insulated; light gray	www.wago.com/2002-480
	Item no.: 2002-477/011-000 Staggered jumper; insulated; light gray	www.wago.com/2002-477/011-000
	Item no.: 2002-481/011-000 Staggered jumper; insulated; light gray	www.wago.com/2002-481/011-000
	Item no.: 2002-481 Staggered jumper; 11-way; insulated; light gray	www.wago.com/2002-481
	Item no.: 2002-482 Staggered jumper; 12-way; insulated; light gray	www.wago.com/2002-482
	Item no.: 210-103 Wire commoning chain; insulated; black	www.wago.com/210-103
	Item no.: 2002-424/000-006 Continuous jumper; from 1 to 4; insulated; blue	www.wago.com/2002-424/000-006
Carrier rail		
Mounting accessories		
	Item no.: 210-197 Steel carrier rail; 35 x 15 mm; 1.5 mm thick; 2 m long; slotted; similar to EN 60715; silver-colored	www.wago.com/210-197
	Item no.: 210-198 Copper carrier rail; 35 x 15 mm; 2.3 mm thick; 2 m long; unslotted; according to EN 60715; copper-colored	www.wago.com/210-198
	Item no.: 210-113 Steel carrier rail; 35 x 7.5 mm; 1 mm thick; 2 m long; unslotted; according to EN 60715; silver-colored	www.wago.com/210-113
	Item no.: 210-118 Steel carrier rail; 35 x 15 mm; 2.3 mm thick; 2 m long; unslotted; according to EN 60715; silver-colored	www.wago.com/210-118

Subject to changes. Please also observe the further product documentation!



Item no.: 210-112

Steel carrier rail; 35 x 7.5 mm; 1 mm thick; 2 m long; slotted; according to EN 60715; "Hole width 25 mm; www.wago.com/210-112
silver-colored



Item no.: 210-114

Steel carrier rail; 35 x 15 mm; 1.5 mm thick; 2 m long; unslotted; similar to EN 60715; silver-colored www.wago.com/210-114



Item no.: 210-115

Steel carrier rail; 35 x 7.5 mm; 1 mm thick; 2 m long; slotted; according to EN 60715; "Hole width 18 mm; www.wago.com/210-115
silver-colored

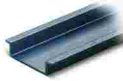

Item no.: 210-196

Aluminum carrier rail; 35 x 8.2 mm; 1.6 mm thick; 2 m long; unslotted; similar to EN 60715; silver-colored www.wago.com/210-196

Insulation stop

Insulation stop



Item no.: 2002-171

Insulation stop; 0.25 - 0.5 mm²; 5 pieces/strip; light gray www.wago.com/2002-171



Item no.: 2002-172

Insulation stop; 0.75 - 1 mm²; 5 pieces/strip; dark gray www.wago.com/2002-172

Mounting

Cover carrier



Item no.: 709-169

Cover carrier; Type 3; gray www.wago.com/709-169

Cover



Item no.: 709-156

Cover; Type 3; suitable for cover carrier, type 3; 1 m long; transparent www.wago.com/709-156

Mounting accessories



Item no.: 2009-305

Busbar carrier; with end stop function and detachable separator plate; for DIN 35 rail; 7.5 mm thick; blue www.wago.com/2009-305



Item no.: 2009-304

Busbar carrier; not suitable for use as end stop; for DIN 35 rail; 1.5 mm thick; blue www.wago.com/2009-304

Marking accessories

Marking strip



Item no.: 2009-110

Marking strips; for Smart Printer; on reel; not stretchable; plain; snap-on type; white www.wago.com/2009-110

Marker carrier



Item no.: 2009-198

Adaptor; gray www.wago.com/2009-198

Subject to changes. Please also observe the further product documentation!

WAGO GmbH & Co. KG

Hansastr. 27

32423 Minden













Phone: +49571 887-0 | Fax: +49571 887-169

Email: info.de@wago.com | Web: www.wago.com













Do you have any questions about our products?

We are always happy to take your call at +49 (571) 887-44222.

Marker

	Item no.: 2009-115/000-002 WMB-Inline; for Smart Printer; 1500 pieces on roll; stretchable 5 - 5.2 mm; plain; snap-on type; yellow	www.wago.com/2009-115/000-002
	Item no.: 2009-115/000-007 WMB-Inline; for Smart Printer; 1500 pieces on roll; stretchable 5 - 5.2 mm; plain; snap-on type; gray	www.wago.com/2009-115/000-007
	Item no.: 2009-115/000-017 WMB-Inline; for Smart Printer; 1500 pieces on roll; stretchable 5 - 5.2 mm; plain; snap-on type; light green	www.wago.com/2009-115/000-017
	Item no.: 2009-115/000-023 WMB-Inline; for Smart Printer; 1500 pieces on roll; stretchable 5 - 5.2 mm; plain; snap-on type; green	www.wago.com/2009-115/000-023
	Item no.: 2009-115/000-024 WMB-Inline; for Smart Printer; 1500 pieces on roll; stretchable 5 - 5.2 mm; plain; snap-on type; violet	www.wago.com/2009-115/000-024
	Item no.: 2009-145/000-006 Mini-WSB Inline; for Smart Printer; 1700 pieces on roll; stretchable 5 - 5.2 mm; plain; snap-on type; blue	www.wago.com/2009-145/000-006
	Item no.: 2009-145 Mini-WSB Inline; for Smart Printer; 1700 pieces on roll; stretchable 5 - 5.2 mm; plain; snap-on type; white	www.wago.com/2009-145
	Item no.: 2009-145/000-002 Mini-WSB Inline; for Smart Printer; 1700 pieces on roll; stretchable 5 - 5.2 mm; plain; snap-on type; yellow	www.wago.com/2009-145/000-002
	Item no.: 2009-145/000-007 Mini-WSB Inline; for Smart Printer; 1700 pieces on roll; stretchable 5 - 5.2 mm; plain; snap-on type; gray	www.wago.com/2009-145/000-007
	Item no.: 2009-145/000-005 Mini-WSB Inline; for Smart Printer; 1700 pieces on roll; stretchable 5 - 5.2 mm; plain; snap-on type; red	www.wago.com/2009-145/000-005
	Item no.: 2009-145/000-012 Mini-WSB Inline; for Smart Printer; 1700 pieces on roll; stretchable 5 - 5.2 mm; plain; snap-on type; orange	www.wago.com/2009-145/000-012
	Item no.: 2009-145/000-023 Mini-WSB Inline; for Smart Printer; 1700 pieces on roll; stretchable 5 - 5.2 mm; plain; snap-on type; green	www.wago.com/2009-145/000-023
	Item no.: 2009-145/000-024 Mini-WSB Inline; for Smart Printer; 1700 pieces on roll; stretchable 5 - 5.2 mm; plain; snap-on type; violet	www.wago.com/2009-145/000-024

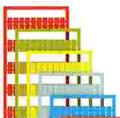
Subject to changes. Please also observe the further product documentation!

	<p>Item no.: 2009-115 WMB-Inline; for Smart Printer; 1500 pieces on roll; stretchable 5 - 5.2 mm; plain; snap-on type; white</p>	www.wago.com/2009-115
	<p>Item no.: 248-501/000-006 Mini-WSB marking card; as card; not stretchable; plain; snap-on type; blue</p>	www.wago.com/248-501/000-006
	<p>Item no.: 248-501/000-007 Mini-WSB marking card; as card; not stretchable; plain; snap-on type; gray</p>	www.wago.com/248-501/000-007
	<p>Item no.: 248-501/000-002 Mini-WSB marking card; as card; not stretchable; plain; snap-on type; yellow</p>	www.wago.com/248-501/000-002
	<p>Item no.: 248-501/000-012 Mini-WSB marking card; as card; not stretchable; plain; snap-on type; orange</p>	www.wago.com/248-501/000-012
	<p>Item no.: 248-501 Mini-WSB marking card; as card; not stretchable; plain; snap-on type; white</p>	www.wago.com/248-501
	<p>Item no.: 248-501/000-017 Mini-WSB marking card; as card; not stretchable; plain; snap-on type; light green</p>	www.wago.com/248-501/000-017
	<p>Item no.: 248-501/000-005 Mini-WSB marking card; as card; not stretchable; plain; snap-on type; red</p>	www.wago.com/248-501/000-005
	<p>Item no.: 248-501/000-024 Mini-WSB marking card; as card; not stretchable; plain; snap-on type; violet</p>	www.wago.com/248-501/000-024
	<p>Item no.: 248-501/000-023 Mini-WSB marking card; as card; not stretchable; plain; snap-on type; green</p>	www.wago.com/248-501/000-023
	<p>Item no.: 793-5501/000-007 WMB marking card; as card; for terminal block width 5 - 17.5 mm; stretchable 5 - 5.2 mm; plain; snap-on type; gray</p>	www.wago.com/793-5501/000-007
	<p>Item no.: 793-5501/000-012 WMB marking card; as card; for terminal block width 5 - 17.5 mm; stretchable 5 - 5.2 mm; plain; snap-on type; orange</p>	www.wago.com/793-5501/000-012

Subject to changes. Please also observe the further product documentation!



Item no.: 793-5501/000-014

WMB marking card; as card; for terminal block width 5 - 17.5 mm; stretchable 5 - 5.2 mm; plain; snap-on type; brown www.wago.com/793-5501/000-014



Item no.: 793-5501/000-017

WMB marking card; as card; for terminal block width 5 - 17.5 mm; stretchable 5 - 5.2 mm; plain; snap-on type; light green www.wago.com/793-5501/000-017



Item no.: 793-5501/000-023

WMB marking card; as card; for terminal block width 5 - 17.5 mm; stretchable 5 - 5.2 mm; plain; snap-on type; green www.wago.com/793-5501/000-023



Item no.: 793-5501/000-024

WMB marking card; as card; for terminal block width 5 - 17.5 mm; stretchable 5 - 5.2 mm; plain; snap-on type; violet www.wago.com/793-5501/000-024



Item no.: 793-5501/000-005

WMB marking card; as card; for terminal block width 5 - 17.5 mm; stretchable 5 - 5.2 mm; plain; snap-on type; red www.wago.com/793-5501/000-005



Item no.: 793-5501/000-002

WMB marking card; as card; for terminal block width 5 - 17.5 mm; stretchable 5 - 5.2 mm; plain; snap-on type; yellow www.wago.com/793-5501/000-002



Item no.: 793-5501/000-006

WMB marking card; as card; for terminal block width 5 - 17.5 mm; stretchable 5 - 5.2 mm; plain; snap-on type; blue www.wago.com/793-5501/000-006



Item no.: 793-5501

WMB marking card; as card; for terminal block width 5 - 17.5 mm; stretchable 5 - 5.2 mm; plain; snap-on type; white www.wago.com/793-5501



Item no.: 2009-115/000-012

WMB-Inline; for Smart Printer; 1500 pieces on roll; stretchable 5 - 5.2 mm; plain; snap-on type; orange www.wago.com/2009-115/000-012



Item no.: 2009-115/000-006

WMB-Inline; for Smart Printer; 1500 pieces on roll; stretchable 5 - 5.2 mm; plain; snap-on type; blue www.wago.com/2009-115/000-006



Item no.: 2009-115/000-005

WMB-Inline; for Smart Printer; 1500 pieces on roll; stretchable 5 - 5.2 mm; plain; snap-on type; red www.wago.com/2009-115/000-005

Group marker carrier



Item no.: 2009-193

www.wago.com/2009-193

Subject to changes. Please also observe the further product documentation!

Group marker carrier; gray

**Item no.: 2009-192**

Group marker carrier; gray

www.wago.com/2009-192**Item no.: 2009-191**

Group marker carrier; gray

www.wago.com/2009-191**Push-in type wire jumper**

Jumper

**Item no.: 2009-412**

Push-in type wire jumper; insulated; 60 mm long; black

www.wago.com/2009-412**Item no.: 2009-414**Push-in type wire jumper; 1.5 mm²; insulated; 110 mm long; blackwww.wago.com/2009-414**Item no.: 2009-416**Push-in type wire jumper; 1.5 mm²; insulated; 250 mm long; blackwww.wago.com/2009-416**Item no.: 2009-414/000-005**Push-in type wire jumper; 1.5 mm²; insulated; 110 mm long; blackwww.wago.com/2009-414/000-005**Item no.: 2009-414/000-006**

Push-in type wire jumper; insulated; 110 mm long; black

www.wago.com/2009-414/000-006**Ferrule**

Ferrule

**Item no.: 216-241**Ferrule; Sleeve for 0.5 mm² / 20 AWG; insulated; electro-tin plated; electrolytic copper; gastight crimped; acc. to DIN 46228, Part 4/09.90; whitewww.wago.com/216-241**Item no.: 216-242**Ferrule; Sleeve for 0.75 mm² / 18 AWG; insulated; electro-tin plated; electrolytic copper; gastight crimped; acc. to DIN 46228, Part 4/09.90; graywww.wago.com/216-242**Item no.: 216-243**Ferrule; Sleeve for 1 mm² / AWG 18; insulated; electro-tin plated; electrolytic copper; gastight crimped; acc. to DIN 46228, Part 4/09.90; redwww.wago.com/216-243**Item no.: 216-244**Ferrule; Sleeve for 1.5 mm² / AWG 16; insulated; electro-tin plated; electrolytic copper; gastight crimped; acc. to DIN 46228, Part 4/09.90; blackwww.wago.com/216-244**Item no.: 216-263**Ferrule; Sleeve for 1 mm² / AWG 18; insulated; electro-tin plated; electrolytic copper; gastight crimped; acc. to DIN 46228, Part 4/09.90; redwww.wago.com/216-263**Item no.: 216-246**Ferrule; Sleeve for 2.5 mm² / AWG 14; insulated; electro-tin plated; electrolytic copper; gastight crimped; acc. to DIN 46228, Part 4/09.90; bluewww.wago.com/216-246**Item no.: 216-266**Ferrule; Sleeve for 2.5 mm² / AWG 14; insulated; electro-tin plated; electrolytic copper; gastight crimped; acc. to DIN 46228, Part 4/09.90; bluewww.wago.com/216-266**Item no.: 216-264**

Subject to changes. Please also observe the further product documentation!

WAGO GmbH & Co. KG

Hansastr. 27



32423 Minden

Phone: +49571 887-0 | Fax: +49571 887-169

Email: info.de@wago.com | Web: www.wago.com

Do you have any questions about our products?

We are always happy to take your call at +49 (571) 887-44222.

	Ferrule; Sleeve for 1.5 mm ² / AWG 16; insulated; electro-tin plated; electrolytic copper; gastight crimped; acc. to DIN 46228, Part 4/09.90; black	www.wago.com/216-264
	Item no.: 216-262 Ferrule; Sleeve for 0.75 mm ² / 18 AWG; insulated; electro-tin plated; electrolytic copper; gastight crimped; acc. to DIN 46228, Part 4/09.90; gray	www.wago.com/216-262

Downloads

Documentation

Bid Text

2003-7650 X81 - Datei	2019 Apr 29	xml 4.0 kB	Download
2003-7650 docx - Datei	2019 Apr 29	docx 15.0 kB	Download

Additional Information

Technical Section Technical explanations		pdf 2.2 MB	Download
---------------------------------------------	--	---------------	----------

CAD/CAE-Data

CAE data

WSCAD Universe 2003-7650		URL	Download
ZUKEN Portal 2003-7650		URL	Download
EPLAN Data Portal 2003-7650		URL	Download

CAD data

2D/3D Models 2003-7650		URL	Download
------------------------	--	-----	----------

Environmental Product Compliance

Compliance Search

Environmental Product Compliance 2003-7650 Multilevel installation terminal block; with operating slots; 2.5 mm ² ; L; Push-in CAGE CLAMP®; 2,50 mm ² ; gray		URL	Download
---------------------------------------------------------------------------------------------------------------------------------------------------------------------------------------	--	-----	----------

Subject to changes. Please also observe the further product documentation!

Installation Notes

Conductor termination

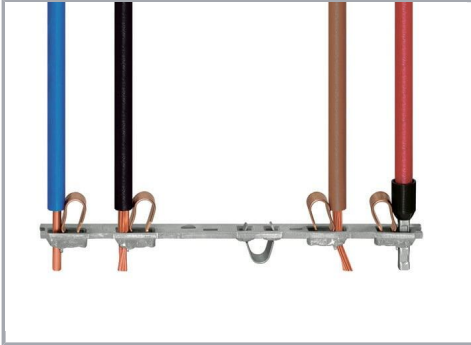

All conductor types at a glance

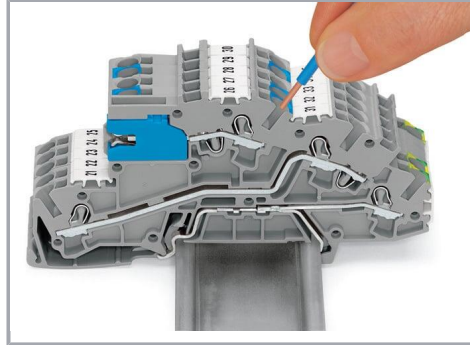

Inserting a conductor via push-in termination.

Solid conductors with cross-sections from either one size above, or up to two sizes below, the rated cross-section can be simply pushed in – no tools needed.

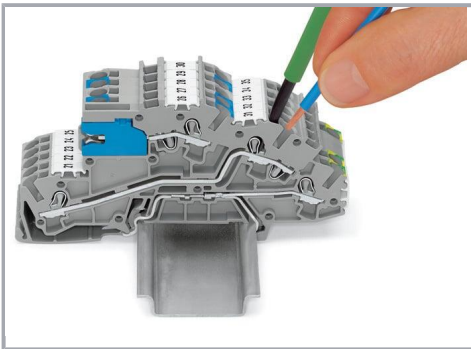

Inserting a conductor via operating tool.

Connecting fine-stranded conductors without ferrules, or small cross-sectional conductors that cannot be pushed in, is performed similarly to the original CAGE CLAMP® – just use an operating tool.

Commoning

Subject to changes. Please also observe the further product documentation!

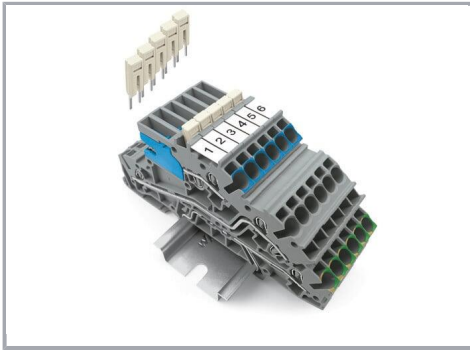

Adjacent Jumpers for Continuous Commoning (2002-400)

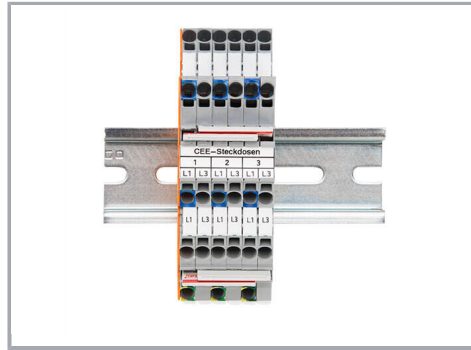

Commoning two potentials in one single jumper slot via extremely slim staggered jumpers.

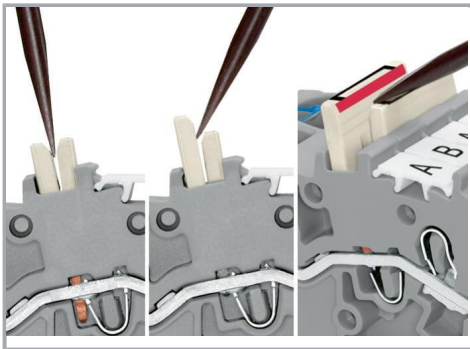

Removing a staggered jumper:

Insert the operating tool between the staggered jumpers, then lift up the jumper.

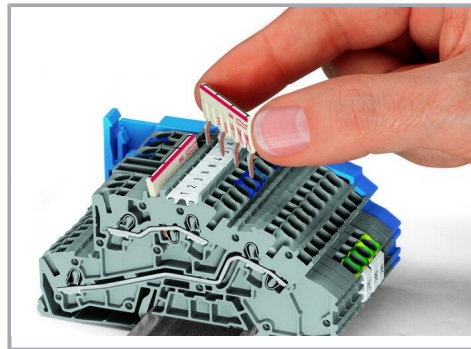

Orient the staggered jumpers' red stripes on the inside.

Insert the staggered jumper and push down until it hits the backstop.

Subject to changes. Please also observe the further product documentation!

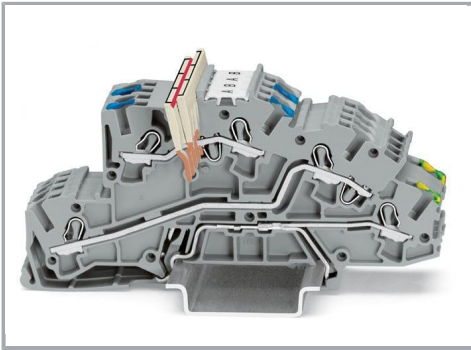

Orient the staggered jumpers' red stripes on the inside.

Insert the staggered jumper and push down until it hits the backstop.

Testing

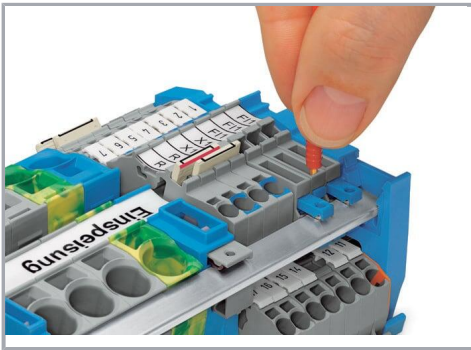

Busbar

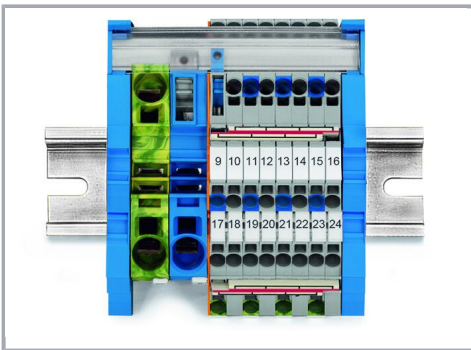

Mounting busbars on busbar carriers: Insert busbar ends onto large busbar carriers (2009-305) or onto supply terminal blocks with an integrated busbar carrier.

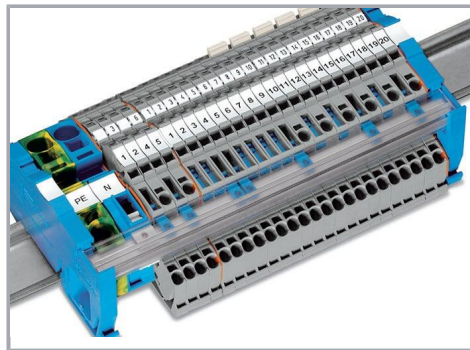

The busbar transparent cover (Item No. 777-303) protects the busbar against accidental contact and makes it easy to see which terminal blocks are connected to the busbar.

Subject to changes. Please also observe the further product documentation!



Product family

TOPJOB® S

TOPJOB® S: In various industrial applications and modern building installations, WAGO's wide and versatile range of rail-mount terminal blocks provides more than just reliable electrical connections.

[Show all products from the family](#)

Subject to changes. Please also observe the further product documentation!