

Product Change Notification

(Notification - P1803021-DIGI)

(DPE002/ HMRL-AC-17-0014 / 3-4)

March 30, 2018

To: *Our Valued Digi-Key Electronics Customer*

Overview: The purpose of this notification is to communicate a product change of select Renesas Electronics America, Inc. (REA) devices.

This notification announces one or more of the following change to select RL78 G13/G14 devices (see Appendix 2 for details of the specific change).

1. Addition of RSB & ASEKH as assembly sites
2. Addition of RSB & KYEC as final test sites
3. Package Dimensional Tolerance specification change
4. Lead Frame Die Pad shape change
5. Die Mount material change
6. Bonding Wire change from Gold (Au) to Copper (Cu)
7. Mold Resin material change
8. Top Mark visibility change
9. Desiccant change
10. Embossed Tape storage number change

There is a part number change. There is no change in product specifications and/or characteristics. There is no impact to quality and/or reliability.

Affected Products: A review of our records indicates the attached list (see Appendix 1) of products may affected your company.

Part numbers given in this list are for active part numbers in REA database at the time of this notification.

Key Dates:

Shipments from REA of replacement products begins.
--

Aug. 1st, 2018

Response: No response is required. REA will consider this notification approved 30 days after its issue. If you anticipate volumes beyond your regular rate prior to the transition date, please contact your REA sales representative with a forecast of your requirements.

You are encouraged to sample the suggested replacement device and begin qualification as soon as possible. Please contact you REA sales representative to obtain samples.

If the customer provides a timely acknowledgement, the customer shall have 90 days (an additional 60 days) from the date of receipt of this notification in which to make any objections to the notification. If the customer does not make any objections to this notification within 90 days of the receipt of the notification, then Renesas will consider the notification as approved. If customer cannot accept the notification, then the customer must provide Renesas with a last time buy demand and purchase order.

Please contact your REA sales representative for any questions or comments.

Thank you for your attention.

Sincerely,

Renesas Electronics America, Inc.

Appendix 1: Digi-Key Part List

Booking Part Number	Replacement PN	PCN Notes for Customer Notification
R5F100GAAFB#V0	R5F100GAAFB#30	<ol style="list-style-type: none"> 1. Addition of RSB & ASEKH as assembly sites; 2. Addition of RSB & KYEC as final test sites; 3. Package Dimensional Tolerance specification change; 4. Lead Frame Die Pad shape change; 5. Die Mount material change; 6. Bonding Wire change from Gold (Au) to Copper (Cu); 7. Mold Resin material change; 8. Top Mark visibility change;
R5F100GADFB#V0	R5F100GADFB#30	
R5F100GCAFB#V0	R5F100GCAFB#30	
R5F100GCDFB#V0	R5F100GCDFB#30	
R5F100GDAFB#V0	R5F100GDAFB#30	
R5F100GDDFB#V0	R5F100GDDFB#30	
R5F100GEAFB#V0	R5F100GEAFB#30	
R5F100GEDFB#V0	R5F100GEDFB#30	
R5F100GFAFB#V0	R5F100GFAFB#30	
R5F100GFDFB#V0	R5F100GFDFB#30	
R5F100GGAFB#V0	R5F100GGAFB#30	
R5F100GGDFB#V0	R5F100GGDFB#30	
R5F100GHAFB#V0	R5F100GHAFB#30	
R5F100GHDFB#V0	R5F100GHDFB#30	
R5F100GJAFB#V0	R5F100GJAFB#30	
R5F100JDFOB#V0	R5F100JDFOB#30	
R5F100LCAFB#V0	R5F100LCAFB#30	
R5F100LCDFB#V0	R5F100LCDFB#30	
R5F100LDAFB#V0	R5F100LDAFB#30	
R5F100LDDFB#V0	R5F100LDDFB#30	
R5F100LEAFB#V0	R5F100LEAFB#30	
R5F100LEDFB#V0	R5F100LEDFB#30	
R5F100LFAFB#V0	R5F100LFAFB#30	
R5F100LFDFOB#V0	R5F100LFDFOB#30	
R5F100LGAFB#V0	R5F100LGAFB#30	
R5F100LGDFB#V0	R5F100LGDFB#30	
R5F100LHAFB#V0	R5F100LHAFB#30	
R5F100LHDFB#V0	R5F100LHDFB#30	
R5F100LJAFB#V0	R5F100LJAFB#30	
R5F100LJDFB#V0	R5F100LJDFB#30	
R5F100MFAFB#V0	R5F100MFAFB#30	
R5F100MFDFOB#V0	R5F100MFDFOB#30	
R5F100MGAFB#V0	R5F100MGAFB#30	
R5F100MGDFB#V0	R5F100MGDFB#30	
R5F100MHAFB#V0	R5F100MHAFB#30	
R5F100MHDFB#V0	R5F100MHDFB#30	
R5F100MJAFB#V0	R5F100MJAFB#30	
R5F100PFAFB#V0	R5F100PFAFB#30	
R5F100PFDFB#V0	R5F100PFDFB#30	
R5F100PGAFB#V0	R5F100PGAFB#30	
R5F100PGDFB#V0	R5F100PGDFB#30	
R5F100PHAFB#V0	R5F100PHAFB#30	
R5F100PHDFB#V0	R5F100PHDFB#30	
R5F100PJAFB#V0	R5F100PJAFB#30	
R5F100PJDFB#V0	R5F100PJDFB#30	

Appendix 1: Digi-Key Part List (cont.)

Booking Part Number	Replacement PN	PCN Notes for Customer Notification
R5F101GAAFB#V0	R5F101GAAFB#30	<ol style="list-style-type: none"> 1. Addition of RSB & ASEKH as assembly sites; 2. Addition of RSB & KYEC as final test sites; 3. Package Dimensional Tolerance specification change; 4. Lead Frame Die Pad shape change; 5. Die Mount material change; 6. Bonding Wire change from Gold (Au) to Copper (Cu); 7. Mold Resin material change; 8. Top Mark visibility change;
R5F101GADFB#V0	R5F101GADFB#30	
R5F101GCAFB#V0	R5F101GCAFB#30	
R5F101GCDFB#V0	R5F101GCDFB#30	
R5F101GDAFB#V0	R5F101GDAFB#30	
R5F101GDDFB#V0	R5F101GDDFB#30	
R5F101GEAFB#V0	R5F101GEAFB#30	
R5F101GEDFB#V0	R5F101GEDFB#30	
R5F101GFAFB#V0	R5F101GFAFB#30	
R5F101GFDFB#V0	R5F101GFDFB#30	
R5F101GGAFB#V0	R5F101GGAFB#30	
R5F101GGDFB#V0	R5F101GGDFB#30	
R5F101GHAFB#V0	R5F101GHAFB#30	
R5F101GHDFB#V0	R5F101GHDFB#30	
R5F101GJAFB#V0	R5F101GJAFB#30	
R5F101GJDFB#V0	R5F101GJDFB#30	
R5F101LCAFB#V0	R5F101LCAFB#30	
R5F101LCDFB#V0	R5F101LCDFB#30	
R5F101LDAFB#V0	R5F101LDAFB#30	
R5F101LDDFB#V0	R5F101LDDFB#30	
R5F101LEAFB#V0	R5F101LEAFB#30	
R5F101LEDFB#V0	R5F101LEDFB#30	
R5F101LFAFB#V0	R5F101LFAFB#30	
R5F101LFDDB#V0	R5F101LFDDB#30	
R5F101LGAFB#V0	R5F101LGAFB#30	
R5F101LGDFB#V0	R5F101LGDFB#30	
R5F101LHAFB#V0	R5F101LHAFB#30	
R5F101LHDFB#V0	R5F101LHDFB#30	
R5F101LJAFB#V0	R5F101LJAFB#30	
R5F101LJDFB#V0	R5F101LJDFB#30	
R5F101MFAFB#V0	R5F101MFAFB#30	
R5F101MGAFB#V0	R5F101MGAFB#30	
R5F101MHAFB#V0	R5F101MHAFB#30	
R5F101MJAFB#V0	R5F101MJAFB#30	
R5F101MJDFB#V0	R5F101MJDFB#30	
R5F101PFAFB#V0	R5F101PFAFB#30	
R5F101PFDFB#V0	R5F101PFDFB#30	
R5F101PGAFB#V0	R5F101PGAFB#30	
R5F101PGDFB#V0	R5F101PGDFB#30	
R5F101PHAFB#V0	R5F101PHAFB#30	
R5F101PHDFB#V0	R5F101PHDFB#30	
R5F101PJAFB#V0	R5F101PJAFB#30	
R5F101PJDFB#V0	R5F101PJDFB#30	
R5F104GAAFB#V0	R5F104GAAFB#30	
R5F104GADFB#V0	R5F104GADFB#30	

Appendix 1: Digi-Key Part List (cont.)

Booking Part Number	Replacement PN	PCN Notes for Customer Notification
R5F104GCAFB#V0	R5F104GCAFB#30	<ol style="list-style-type: none"> 1. Addition of RSB & ASEKH as assembly sites; 2. Addition of RSB & KYEC as final test sites; 3. Package Dimensional Tolerance specification change; 4. Lead Frame Die Pad shape change; 5. Die Mount material change; 6. Bonding Wire change from Gold (Au) to Copper (Cu); 7. Mold Resin material change; 8. Top Mark visibility change;
R5F104GCDFB#V0	R5F104GCDFB#30	
R5F104GDAFB#V0	R5F104GDAFB#30	
R5F104GDDFB#V0	R5F104GDDFB#30	
R5F104GEAFB#V0	R5F104GEAFB#30	
R5F104GEDFB#V0	R5F104GEDFB#30	
R5F104GFAFB#V0	R5F104GFAFB#30	
R5F104GFDFB#V0	R5F104GFDFB#30	
R5F104GGAFB#V0	R5F104GGAFB#30	
R5F104GGDFB#V0	R5F104GGDFB#30	
R5F104GHAFB#V0	R5F104GHAFB#30	
R5F104GHDFB#V0	R5F104GHDFB#30	
R5F104GJAFB#V0	R5F104GJAFB#30	
R5F104GJDFB#V0	R5F104GJDFB#30	
R5F104LCAFB#V0	R5F104LCAFB#30	
R5F104LCDFB#V0	R5F104LCDFB#30	
R5F104LDAFB#V0	R5F104LDAFB#30	
R5F104LDDFB#V0	R5F104LDDFB#30	
R5F104LEAFB#V0	R5F104LEAFB#30	
R5F104LEDFB#V0	R5F104LEDFB#30	
R5F104LFAFB#V0	R5F104LFAFB#30	
R5F104LGAFB#V0	R5F104LGAFB#30	
R5F104LGAXXFB#V0	R5F104LGAXXFB#30	
R5F104LHAFB#V0	R5F104LHAFB#30	
R5F104LJAFB#V0	R5F104LJAFB#30	
R5F104MFAFB#V0	R5F104MFAFB#30	
R5F104MGAFB#V0	R5F104MGAFB#30	
R5F104MGDFB#V0	R5F104MGDFB#30	
R5F104MHAFB#V0	R5F104MHAFB#30	
R5F104MJAFB#V0	R5F104MJAFB#30	
R5F104PFAFB#V0	R5F104PFAFB#30	
R5F104PFDFB#V0	R5F104PFDFB#30	
R5F104PGAFB#V0	R5F104PGAFB#30	
R5F104PHAFB#V0	R5F104PHAFB#30	
R5F104PJAFB#V0	R5F104PJAFB#30	

Appendix 1: Digi-Key Part List (cont.)

Booking Part Number	Replacement PN	PCN Notes for Customer Notification
R5F100GAAFB#X0	R5F100GAAFB#50	<ol style="list-style-type: none"> 1. Addition of RSB & ASEKH as assembly sites; 2. Addition of RSB & KYEC as final test sites; 3. Package Dimensional Tolerance specification change; 4. Lead Frame Die Pad shape change; 5. Die Mount material change; 6. Bonding Wire change from Gold (Au) to Copper (Cu); 7. Mold Resin material change; 8. Top Mark visibility change; 9. Desiccant change;
R5F100GADFB#X0	R5F100GADFB#50	
R5F100GCAFB#X0	R5F100GCAFB#50	
R5F100GCDFB#X0	R5F100GCDFB#50	
R5F100GDAFB#X0	R5F100GDAFB#50	
R5F100GEAFB#X0	R5F100GEAFB#50	
R5F100GEDFB#X0	R5F100GEDFB#50	
R5F100GFABF#X0	R5F100GFABF#50	
R5F100GFDFB#X0	R5F100GFDFB#50	
R5F100GGAFB#X0	R5F100GGAFB#50	
R5F100GGDFB#X0	R5F100GGDFB#50	
R5F100GHAFB#X0	R5F100GHAFB#50	
R5F100GHDFB#X0	R5F100GHDFB#50	
R5F100GJAFB#X0	R5F100GJAFB#50	
R5F100GJDFB#X0	R5F100GJDFB#50	
R5F100MFAFB#X0	R5F100MFAFB#50	
R5F100MDFB#X0	R5F100MDFB#50	
R5F100MGAFB#X0	R5F100MGAFB#50	
R5F100MGDFB#X0	R5F100MGDFB#50	
R5F100MHAFB#X0	R5F100MHAFB#50	
R5F100MHDFB#X0	R5F100MHDFB#50	
R5F100MJAFB#X0	R5F100MJAFB#50	
R5F100PFAFB#X0	R5F100PFAFB#50	
R5F100PFDFB#X0	R5F100PFDFB#50	
R5F100PGAFB#X0	R5F100PGAFB#50	
R5F100PGDFB#X0	R5F100PGDFB#50	
R5F100PHAFB#X0	R5F100PHAFB#50	
R5F100PHDFB#X0	R5F100PHDFB#50	
R5F100PJAFB#X0	R5F100PJAFB#50	
R5F100PJDFB#X0	R5F100PJDFB#50	
R5F101GAAFB#X0	R5F101GAAFB#50	
R5F101GADFB#X0	R5F101GADFB#50	
R5F101GCAFB#X0	R5F101GCAFB#50	
R5F101GCDFB#X0	R5F101GCDFB#50	
R5F101GDAFB#X0	R5F101GDAFB#50	
R5F101GDDFB#X0	R5F101GDDFB#50	
R5F101GEAFB#X0	R5F101GEAFB#50	
R5F101GEDFB#X0	R5F101GEDFB#50	
R5F101GFABF#X0	R5F101GFABF#50	
R5F101GFDFB#X0	R5F101GFDFB#50	
R5F101GGAFB#X0	R5F101GGAFB#50	
R5F101GGDFB#X0	R5F101GGDFB#50	
R5F101GHAFB#X0	R5F101GHAFB#50	
R5F101GHDFB#X0	R5F101GHDFB#50	
R5F101GJAFB#X0	R5F101GJAFB#50	

Appendix 1: Digi-Key Part List (cont.)

Booking Part Number	Replacement PN	PCN Notes for Customer Notification
R5F101GJDFB#X0	R5F101GJDFB#50	1. Addition of RSB & ASEKH as assembly sites; 2. Addition of RSB & KYEC as final test sites; 3. Package Dimensional Tolerance specification change; 4. Lead Frame Die Pad shape change; 5. Die Mount material change; 6. Bonding Wire change from Gold (Au) to Copper (Cu); 7. Mold Resin material change; 8. Top Mark visibility change; 9. Desiccant change;
R5F101MGAFB#X0	R5F101MGAFB#50	
R5F101MHAFB#X0	R5F101MHAFB#50	
R5F101MJAFB#X0	R5F101MJAFB#50	
R5F101MJDFB#X0	R5F101MJDFB#50	
R5F104GADFB#X0	R5F104GADFB#50	
R5F104GCAFB#X0	R5F104GCAFB#50	
R5F104GCDFB#X0	R5F104GCDFB#50	
R5F104GDAFB#X0	R5F104GDAFB#50	
R5F104GDDFB#X0	R5F104GDDFB#50	
R5F104GEAFB#X0	R5F104GEAFB#50	
R5F104GEDFB#X0	R5F104GEDFB#50	
R5F104GFAFB#X0	R5F104GFAFB#50	
R5F104GGAFB#X0	R5F104GGAFB#50	
R5F104GJAFB#X0	R5F104GJAFB#50	
R5F104MFAFB#X0	R5F104MFAFB#50	
R5F104MGAFB#X0	R5F104MGAFB#50	
R5F104MGDFB#X0	R5F104MGDFB#50	
R5F104MJAFB#X0	R5F104MJAFB#50	
R5F104PFAFB#X0	R5F104PFAFB#50	
R5F104PJAFB#X0	R5F104PJAFB#50	

Appendix 1: Digi-Key Part List (cont.)

Booking Part Number	Replacement PN	PCN Notes for Customer Notification
R5F100LCDFB#X0	R5F100LCDFB#50	1. Addition of RSB & ASEKH as assembly sites; 2. Addition of RSB & KYEC as final test sites; 3. Package Dimensional Tolerance specification change; 4. Lead Frame Die Pad shape change; 5. Die Mount material change; 6. Bonding Wire change from Gold (Au) to Copper (Cu); 7. Mold Resin material change; 8. Top Mark visibility change; 9. Desiccant change; 10. Embossed Tape storage number change;
R5F100LDAFB#X0	R5F100LDAFB#50	
R5F100LDDFB#X0	R5F100LDDFB#50	
R5F100LEAFB#X0	R5F100LEAFB#50	
R5F100LEDFB#X0	R5F100LEDFB#50	
R5F100LFAFB#X0	R5F100LFAFB#50	
R5F100LFDFB#X0	R5F100LFDFB#50	
R5F100LGAFB#X0	R5F100LGAFB#50	
R5F100LGDFB#X0	R5F100LGDFB#50	
R5F100LHAFB#X0	R5F100LHAFB#50	
R5F100LHDFB#X0	R5F100LHDFB#50	
R5F100LJAFB#X0	R5F100LJAFB#50	
R5F100LJDFB#X0	R5F100LJDFB#50	
R5F101LCAFB#X0	R5F101LCAFB#50	
R5F101LCDFB#X0	R5F101LCDFB#50	
R5F101LDAFB#X0	R5F101LDAFB#50	
R5F101LDDFB#X0	R5F101LDDFB#50	
R5F101LEAFB#X0	R5F101LEAFB#50	
R5F101LEDFB#X0	R5F101LEDFB#50	
R5F101LFAFB#X0	R5F101LFAFB#50	
R5F101LFDFB#X0	R5F101LFDFB#50	
R5F101LGAFB#X0	R5F101LGAFB#50	
R5F101LGDFB#X0	R5F101LGDFB#50	
R5F101LHAFB#X0	R5F101LHAFB#50	
R5F101LHDFB#X0	R5F101LHDFB#50	
R5F101LJAFB#X0	R5F101LJAFB#50	
R5F101LJDFB#X0	R5F101LJDFB#50	
R5F104LCAFB#X0	R5F104LCAFB#50	
R5F104LCDFB#X0	R5F104LCDFB#50	
R5F104LDAFB#X0	R5F104LDAFB#50	
R5F104LDDFB#X0	R5F104LDDFB#50	
R5F104LEAFB#X0	R5F104LEAFB#50	
R5F104LEDFB#X0	R5F104LEDFB#50	
R5F104LFAFB#X0	R5F104LFAFB#50	
R5F104LJAFB#X0	R5F104LJAFB#50	

Appendix 2: Change Details

DIFFERENCE OF SPECIFICATION (RL78/G13,G14)

ASSEMBLY : RSKL → RSB , SORTING : RSKL → RSB,

BONDING WIRE : Au → Cu

MARCH.13, 2018

BROAD-BASED SOLUTION BUSINESS UNIT
RENESAS ELECTRONICS CO., LTD.

TECHNOLOGY DIVISION
RENESAS SEMICONDUCTOR PACKAGE & TEST SOLUTIONS CO.,
LTD.

HMRL-AB-17-0160

Notice

1. Descriptions of circuits, software and other related information in this document are provided only to illustrate the operation of semiconductor products and application examples. You are fully responsible for the incorporation or any other use of the circuits, software, and information in the design of your product or system. Renesas Electronics disclaims any and all liability for any losses and damages incurred by you or third parties arising from the use of these circuits, software, or information.
 2. Renesas Electronics hereby expressly disclaims any warranties against and liability for infringement or any other claims involving patents, copyrights, or other intellectual property rights of third parties, by or arising from the use of Renesas Electronics products or technical information described in this document, including but not limited to, the product data, drawings, charts, programs, algorithms, and application examples.
 3. No license, express, implied or otherwise, is granted hereby under any patents, copyrights or other intellectual property rights of Renesas Electronics or others.
 4. You shall not alter, modify, copy, or reverse engineer any Renesas Electronics product, whether in whole or in part. Renesas Electronics disclaims any and all liability for any losses or damages incurred by you or third parties arising from such alteration, modification, copying or reverse engineering.
 5. Renesas Electronics products are classified according to the following two quality grades: "Standard" and "High Quality". The intended applications for each Renesas Electronics product depends on the product's quality grade, as indicated below.
 - "Standard": Computers; office equipment; communications equipment; test and measurement equipment; audio and visual equipment; home electronic appliances; machine tools; personal electronic equipment; industrial robots; etc.
 - "High Quality": Transportation equipment (automobiles, trains, ships, etc.); traffic control (traffic lights); large-scale communication equipment; key financial terminal systems; safety control equipment; etc.

Unless expressly designated as a high reliability product or a product for harsh environments in a Renesas Electronics data sheet or other Renesas Electronics document, Renesas Electronics products are not intended or authorized for use in products or systems that may pose a direct threat to human life or bodily injury (artificial life support devices or systems; surgical implantations; etc.), or may cause serious property damage (space system; undersea repeaters; nuclear power control systems; aircraft control systems; key plant systems; military equipment; etc.). Renesas Electronics disclaims any and all liability for any damages or losses incurred by you or any third parties arising from the use of any Renesas Electronics product that is inconsistent with any Renesas Electronics data sheet, user's manual or other Renesas Electronics document.
 6. When using Renesas Electronics products, refer to the latest product information (data sheets, user's manuals, application notes, "General Notes for Handling and Using Semiconductor Devices" in the reliability handbook, etc.), and ensure that usage conditions are within the ranges specified by Renesas Electronics with respect to maximum ratings, operating power supply voltage range, heat dissipation characteristics, installation, etc. Renesas Electronics disclaims any and all liability for any malfunctions, failure or accident arising out of the use of Renesas Electronics products outside of such specified ranges.
 7. Although Renesas Electronics endeavors to improve the quality and reliability of Renesas Electronics products, semiconductor products have specific characteristics, such as the occurrence of failure at a certain rate and malfunctions under certain use conditions. Unless designated as a high reliability product or a product for harsh environments in a Renesas Electronics data sheet or other Renesas Electronics document, Renesas Electronics products are not subject to radiation resistance design. You are responsible for implementing safety measures to guard against the possibility of bodily injury, injury or damage caused by fire, and/or danger to the public in the event of a failure or malfunction of Renesas Electronics products, such as safety design for hardware and software, including but not limited to redundancy, fire control and malfunction prevention, appropriate treatment for aging degradation or any other appropriate measures. Because the evaluation of microcomputer software alone is very difficult and impractical, you are responsible for evaluating the safety of the final products or systems manufactured by you.
 8. Please contact a Renesas Electronics sales office for details as to environmental matters such as the environmental compatibility of each Renesas Electronics product. You are responsible for carefully and sufficiently investigating applicable laws and regulations that regulate the inclusion or use of controlled substances, including without limitation, the EU RoHS Directive, and using Renesas Electronics products in compliance with all these applicable laws and regulations. Renesas Electronics disclaims any and all liability for damages or losses occurring as a result of your noncompliance with applicable laws and regulations.
 9. Renesas Electronics products and technologies shall not be used for or incorporated into any products or systems whose manufacture, use, or sale is prohibited under any applicable domestic or foreign laws or regulations. You shall comply with any applicable export control laws and regulations promulgated and administered by the governments of any countries asserting jurisdiction over the parties or transactions.
 10. It is the responsibility of the buyer or distributor of Renesas Electronics products, or any other party who distributes, disposes of, or otherwise sells or transfers the product to a third party, to notify such third party in advance of the contents and conditions set forth in this document.
 11. This document shall not be reprinted, reproduced or duplicated in any form, in whole or in part, without prior written consent of Renesas Electronics.
 12. Please contact a Renesas Electronics sales office if you have any questions regarding the information contained in this document or Renesas Electronics products.
- (Note 1) "Renesas Electronics" as used in this document means Renesas Electronics Corporation and also includes its directly or indirectly controlled subsidiaries.
 (Note 2) "Renesas Electronics product(s)" means any product developed or manufactured by or for Renesas Electronics.

(Rev. 4.0-1 November 2017)

Appendix 2: Change Details (cont.)

Outline

- Addition of assembly factory:
 - Current factory: Renesas Semiconductor KL Sdn. Bhd., (RSKL)
 - Additional factory: Renesas Semiconductor (Beijing) Co., Ltd. (RSB)
- Addition of sorting factory:
 - Current factory: Renesas Semiconductor KL Sdn. Bhd., (RSKL)
 - Additional factory: Renesas Semiconductor (Beijing) Co., Ltd. (RSB)
- Change of material: 1) Bonding wire, 2) Resin, 3) Lead frame, 4) Die mount
- Addition of package outline:
 - Assembly factory is added, and the package outline form is also added.
 - But there is no change for a footprint.
- Change of ordering Part Number:
 - The products which are changed the bonding wire from Gold (Au) to Copper (Cu) are changed the ordering Part Number as follows.
 - Current part number: R5F1*****#V0, R5F1*****#X0
 - New part number: R5F1*****#30, R5F1*****#50
- Change of marking: Changes at assembly factory
- Packing specification: A part of packing material is changed
- Specification and characteristics of product:
 - No change
- Quality and reliability:
 - No change

Difference of specification

Item		Current	New
Assembly factory		RSKL	RSB
Sorting factory		RSKL	RSB
Package	Outline	Change (Refer to pages 5 to 12)	
Lead frame	Material	No change	
	Inner pattern	Change (Refer to page 13)	
Die mount	Material	Ag epoxy paste B	Ag epoxy paste A
Bonding wire	Material	Au	Cu (Pd coating)
Resin	Material	Resin B-1 (halogen-free)	Resin A-2 (halogen-free)
Plating	Material	No change	
Marking	Font	Change (Refer to page 14)	
	Digit number	Change (Refer to pages 15,16)	
Packing	Tray/ Emboss tape	Change (Refer to page 17)	

- ※ There is no impact on reliability and specification by material change.
- ※ The contents of PC-WRP-A001C are not included in the difference.

Appendix 2: Change Details (cont.)

Difference of Outline Dimension_14mm×14mm 100pin

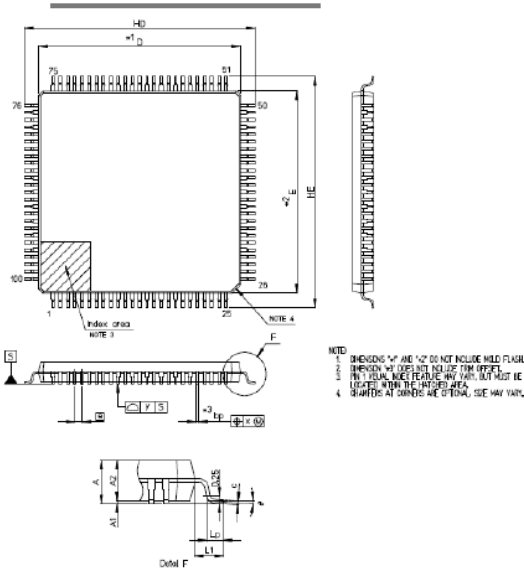

Symbol	Terminology	New	Current
D	Package length	14.0±0.1	14.00±0.20
E	Package width	14.0±0.1	14.00±0.20
A2	Package height	1.4	1.40±0.05
HD	Overall length	16.0±0.2	16.00±0.20
HE	Overall width	16.0±0.2	16.00±0.20
A	Seated height	1.70max	1.60max
A1	1st standoff height	0.05 to 0.15	0.10±0.05
bp	Terminal width	0.20 +0.07/-0.05	0.22±0.05
c	Terminal thickness	0.09 to 0.20	0.145 +0.055/-0.045
θ	Angle of terminal flat portions	3.5° +4.5°/-3.5°	3° +5°/-3°
e	Terminal pitch	0.5	0.50
x	Tolerance value of terminal center position	0.08max	0.08max
y	Coplanarity	0.08max	0.08max
Lp	Length of soldered part	0.60±0.15	0.60±0.15
L1	Terminal length	1.0	1.00±0.20

Difference of Appearance_14mm×14mm 100pin

※Character is reference example

	Package surface	Package back	Lead bending shape
New			
Current			

Appendix 2: Change Details (cont.)

Difference of Outline Dimension_12mm×12mm 80pin

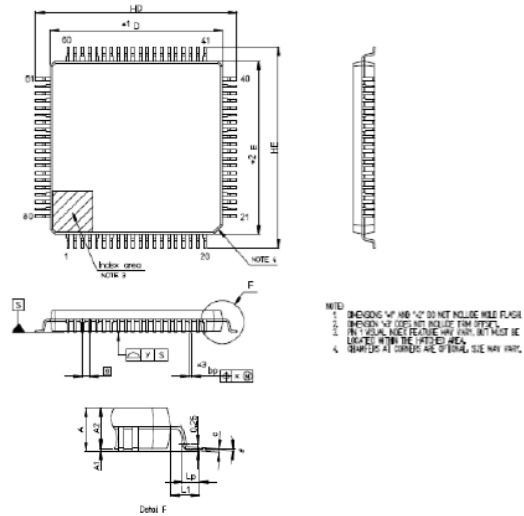

Symbol	Terminology	New	Current
D	Package length	12.0±0.1	12.00±0.20
E	Package width	12.0±0.1	12.00±0.20
A2	Package height	1.4	1.40±0.05
HD	Overall length	14.0±0.2	14.00±0.20
HE	Overall width	14.0±0.2	14.00±0.20
A	Seated height	1.70max	1.60max
A1	1st standoff height	0.05 to 0.15	0.10±0.05
bp	Terminal width	0.20 +0.07/-0.05	0.22±0.05
c	Terminal thickness	0.09 to 0.20	0.145 +0.055/-0.045
θ	Angle of terminal flat portions	3.5° +4.5°/-3.5°	3° +5°/-3°
e	Terminal pitch	0.5	0.50
x	Tolerance value of terminal center position	0.08max	0.08max
y	Coplanarity	0.08max	0.08max
Lp	Length of soldered part	0.60±0.15	0.60±0.15
L1	Terminal length	1.0	1.00±0.20

Difference of Appearance_12mm×12mm 80pin

※Character is reference example

	Package surface	Package back	Lead bending shape
New			
Current			

Appendix 2: Change Details (cont.)

Difference of Outline Dimension_10mm×10mm 64pin

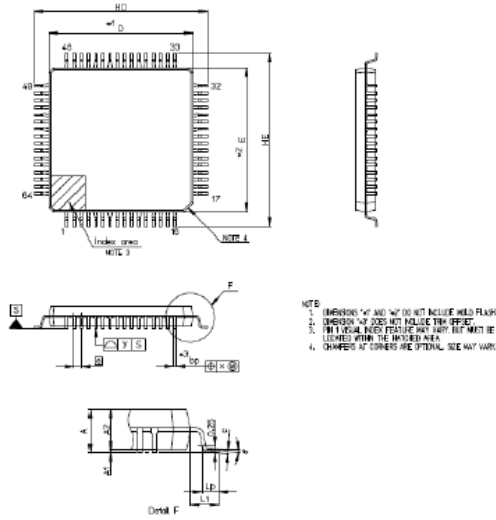

Symbol	Terminology	New	Current
D	Package length	10.0±0.1	10.00±0.20
E	Package width	10.0±0.1	10.00±0.20
A2	Package height	1.4	1.40±0.05
HD	Overall length	12.0±0.2	12.00±0.20
HE	Overall width	12.0±0.2	12.00±0.20
A	Seated height	1.70max	1.60max
A1	1st standoff height	0.05 to 0.15	0.10±0.05
bp	Terminal width	0.20 +0.07/-0.05	0.22±0.05
c	Terminal thickness	0.09 to 0.20	0.145 +0.055/-0.045
θ	Angle of terminal flat portions	3.5° +4.5°/-3.5°	3° +5°/-3°
e	Terminal pitch	0.5	0.50
x	Tolerance value of terminal center position	0.08max	0.08max
y	Coplanarity	0.08max	0.08max
Lp	Length of soldered part	0.60±0.15	0.60±0.15
L1	Terminal length	1.0	1.00±0.20

Difference of Appearance_10mm×10mm 64pin

※Character is reference example

	Package surface	Package back	Lead bending shape
New			
Current			

Appendix 2: Change Details (cont.)

Difference of Outline Dimension_7mm×7mm 48pin

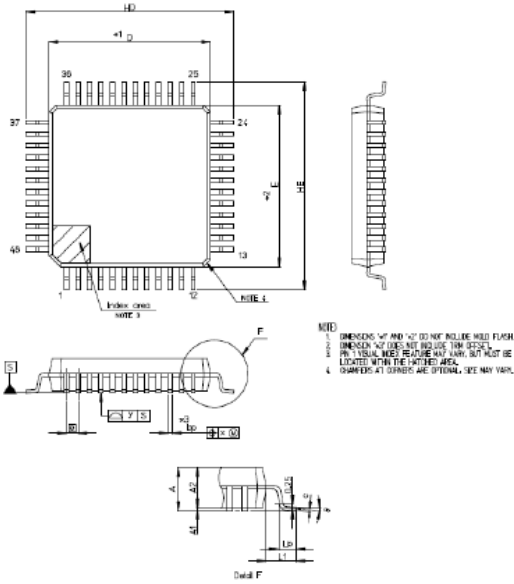

Symbol	Terminology	New	Current
D	Package length	7.0±0.1	7.00±0.20
E	Package width	7.0±0.1	7.00±0.20
A2	Package height	1.4	1.40±0.05
HD	Overall length	9.0±0.2	9.00±0.20
HE	Overall width	9.0±0.2	9.00±0.20
A	Seated height	1.70max	1.60max
A1	1st standoff height	0.05 to 0.15	0.10±0.05
bp	Terminal width	0.20 +0.07/-0.03	0.22±0.05
c	Terminal thickness	0.09 to 0.20	0.145 +0.055/-0.045
θ	Angle of terminal flat portions	3.5° +4.5°/-3.5°	3° +5°/-3°
e	Terminal pitch	0.5	0.50
x	Tolerance value of terminal center position	0.08max	0.08max
y	Coplanarity	0.08max	0.08max
Lp	Length of soldered part	0.60±0.15	0.60±0.15
L1	Terminal length	1.0	1.00±0.20

Difference of Appearance_7mm×7mm 48pin

※Character is reference example

	Package surface	Package back	Lead bending shape
New			
Current			

Appendix 2: Change Details (cont.)

Difference of marking

	Current		New	
48pin	XXXXXX YYYYYYYY •	➡	XXXXXX YYYYYY •	X : Part number : No change (6-digit) Y : Lot number : Change (9 → 7-digit)
64pin	XXXXXXXX YYYYYYYY •	➡	XXXXXXXX YYYYYY •	X : Part number : No change (9-digit) Y : Lot number : Change (9 → 7-digit)
80pin	XXXXXXXX YYYYYYYY ZZZZZZ •	➡	XXXXXXXX YYYYYY •	X : Part number : No change (9-digit) Y : Lot number : Change (9 → 7-digit) Z : Country of origin : Change (8-digit → Non)
100pin	XXXXXXXX YYYYYYYY ZZZZZZ •	➡	XXXXXXXX YYYYYY •	X : Part number : No change (9-digit) Y : Lot number : Change (9 → 7-digit) Z : Country of origin : Change (8-digit → Non)

Difference of marking

	Current		New	
48pin	XXXXX YYYYYYYY CCC •	➡	XXXXX YYYYYY CCC •	X : Part number : No change (5-digit) Y : Lot number : Change (9 → 7-digit) C : ROM code : No change (3-digit)
64pin	XXXXXXXX CCC YYYYYYYY •	➡	CCC XXXXXXXX YYYYYY •	X : Part number : Change (Line change) Digit isn't change C : ROM code : Change (Line change) Digit isn't change Y : Lot number : Change (9 → 7-digit)
80pin	XXXXXXXX CCC YYYYYYYY ZZZZZZ •	➡	XXXXXXXX CCC YYYYYY •	X : Part number : No change (8-digit) C : ROM code : No change (3-digit) Y : Lot number : Change (9 → 7-digit) Z : Country of origin : Change (8-digit → Non)
100pin	XXXXXXXX CCC YYYYYYYY ZZZZZZ •	➡	XXXXXXXX CCC YYYYYY •	X : Part number : No change (8-digit) C : ROM code : No change (3-digit) Y : Lot number : Change (9 → 7-digit) Z : Country of origin : Change (8-digit → Non)

Appendix 2: Change Details (cont.)

PACKING SPECIFICATION (Embossed tape)

Storage number:

Only 10mm x 10mm 64pin LQFP embossed tape will be changed. Other packages are unchanged.

	RSKL	RSB
Ordering Part Number	R5F1*RL**FB#X0	R5F1*RL**FB#50
Embossed tape code	E2416Q10RA	←
Storage number	1000 pcs/reel	1500 pcs/reel

Change of desiccant:

Desiccant of embossed tape packing is different with RSKL and RSB. However, there is no change in the storage term.

	RSKL	RSB
Desiccant		

4M changing points

(Addition of assembly and sorting factory, Change of material)

Item	Check Result	Judgement
Machine	Changing at assembly and sorting. The machines are equivalent to present machines. Copper wire products are produced by same wire-bonding machine applied gold wire. To prevent copper wire oxidization, inert gas is used to wire-bonding process. There are production of similar copper wire products and we have already checked the additional products have no risk on the production.	No risk
Method	Bonding method (thermosonic bonding) and process flow for the Cu wiring are same as the Au wiring.	No risk
Man	Using operator certification system. Only certificated operator can work for the production.	No risk
Material	Using only certificated copper wire. And furthermore certificated materials for the Cu wiring products are applied. The products has been certificated by reliability test same as gold wire products and have no risk.	No risk

Appendix 2: Change Details (cont.)



© 2017 Renesas Electronics Corporation. All rights reserved.

Appendix 3: Change Details

**DIFFERENCE OF SPECIFICATION
(RL78/G13,G14)**

ASSEMBLY: RSKL → ASEKH, SORTING: RSKL → RSB/KYEC
BONDING WIRE: Au/Cu → Cu

MARCH.13, 2018

BROAD-BASED SOLUTION BUSINESS UNIT
RENESAS ELECTRONICS CO., LTD.

TECHNOLOGY DIVISION
RENESAS SEMICONDUCTOR PACKAGE & TEST SOLUTIONS CO., LTD.

HMRL-AB-17-0162

© 2017 Renesas Electronics Corporation. All rights reserved.

Appendix 3: Change Details (cont.)

Notice

1. Descriptions of circuits, software and other related information in this document are provided only to illustrate the operation of semiconductor products and application examples. You are fully responsible for the incorporation or any other use of the circuits, software, and information in the design of your product or system. Renesas Electronics disclaims any and all liability for any losses and damages incurred by you or third parties arising from the use of these circuits, software, or information.
2. Renesas Electronics hereby expressly disclaims any warranties against and liability for infringement or any other claims involving patents, copyrights, or other intellectual property rights of third parties, by or arising from the use of Renesas Electronics products or technical information described in this document, including but not limited to, the product data, drawings, charts, programs, algorithms, and application examples.
3. No license, express, implied or otherwise, is granted hereby under any patents, copyrights or other intellectual property rights of Renesas Electronics or others.
4. You shall not alter, modify, copy, or reverse engineer any Renesas Electronics product, whether in whole or in part. Renesas Electronics disclaims any and all liability for any losses or damages incurred by you or third parties arising from such alteration, modification, copying or reverse engineering.
5. Renesas Electronics products are classified according to the following two quality grades: "Standard" and "High Quality". The intended applications for each Renesas Electronics product depends on the product's quality grade, as indicated below.
 - "Standard": Computers; office equipment; communications equipment; test and measurement equipment; audio and visual equipment; home electronic appliances; machine tools; personal electronic equipment; industrial robots, etc.
 - "High Quality": Transportation equipment (automobiles, trains, ships, etc.); traffic control (traffic lights); large-scale communication equipment; key financial terminal systems; safety control equipment, etc.

Unless expressly designated as a high reliability product or a product for harsh environments in a Renesas Electronics data sheet or other Renesas Electronics document, Renesas Electronics products are not intended or authorized for use in products or systems that may pose a direct threat to human life or bodily injury (artificial life support devices or systems; surgical implantations; etc.), or may cause serious property damage (space system; undersea repeaters; nuclear power control systems; aircraft control systems; key plant systems; military equipment; etc.). Renesas Electronics disclaims any and all liability for any damages or losses incurred by you or any third parties arising from the use of any Renesas Electronics product that is inconsistent with any Renesas Electronics data sheet, user's manual or other Renesas Electronics document.

6. When using Renesas Electronics products, refer to the latest product information (data sheets, user's manuals, application notes, "General Notes for Handling and Using Semiconductor Devices" in the reliability handbook, etc.), and ensure that usage conditions are within the ranges specified by Renesas Electronics with respect to maximum ratings, operating power supply voltage range, heat dissipation characteristics, installation, etc. Renesas Electronics disclaims any and all liability for any malfunctions, failure or accident arising out of the use of Renesas Electronics products outside of such specified ranges.
7. Although Renesas Electronics endeavors to improve the quality and reliability of Renesas Electronics products, semiconductor products have specific characteristics, such as the occurrence of failure at a certain rate and malfunctions under certain use conditions. Unless designated as a high reliability product or a product for harsh environments in a Renesas Electronics data sheet or other Renesas Electronics document, Renesas Electronics products are not subject to radiation resistance design. You are responsible for implementing safety measures to guard against the possibility of bodily injury, injury or damage caused by fire, and/or danger to the public in the event of a failure or malfunction of Renesas Electronics products, such as safety design for hardware and software, including but not limited to redundancy, fire control and malfunction prevention, appropriate treatment for aging degradation or any other appropriate measures. Because the evaluation of microcomputer software alone is very difficult and impractical, you are responsible for evaluating the safety of the final products or systems manufactured by you.
8. Please contact a Renesas Electronics sales office for details as to environmental matters such as the environmental compatibility of each Renesas Electronics product. You are responsible for carefully and sufficiently investigating applicable laws and regulations that regulate the inclusion or use of controlled substances, including without limitation, the EU RoHS Directive, and using Renesas Electronics products in compliance with all these applicable laws and regulations. Renesas Electronics disclaims any and all liability for damages or losses occurring as a result of your noncompliance with applicable laws and regulations.
9. Renesas Electronics products and technologies shall not be used for or incorporated into any products or systems whose manufacture, use, or sale is prohibited under any applicable domestic or foreign laws or regulations. You shall comply with any applicable export control laws and regulations promulgated and administered by the governments of any countries asserting jurisdiction over the parties or transactions.
10. It is the responsibility of the buyer or distributor of Renesas Electronics products, or any other party who distributes, disposes of, or otherwise sells or transfers the product to a third party, to notify such third party in advance of the contents and conditions set forth in this document.
11. This document shall not be reprinted, reproduced or duplicated in any form, in whole or in part, without prior written consent of Renesas Electronics.
12. Please contact a Renesas Electronics sales office if you have any questions regarding the information contained in this document or Renesas Electronics products.

(Note 1) "Renesas Electronics" as used in this document means Renesas Electronics Corporation and also includes its directly or indirectly controlled subsidiaries.
 (Note 2) "Renesas Electronics product(s)" means any product developed or manufactured by or for Renesas Electronics.

(Rev. 4.0-1 November 2017)

Outline

- Addition of assembly factory:
 - Current factory: Renesas Semiconductor KL Sdn. Bhd., (RSKL)
 - Additional factory: ADVANCED SEMICONDUCTOR ENGINEERING, INC. (ASEKH)
- Addition of sorting factory:
 - Current factory: Renesas Semiconductor KL Sdn. Bhd., (RSKL)
 - Additional factory: Renesas Semiconductor (Beijing) Co., Ltd. (RSB)
King Yuan Electronics Co., Ltd. (KVEC)
- Change of material: 1) Bonding wire, 2) Resin, 3) Lead frame, 4) Die mount
- Addition of package outline:
 - Assembly factory is added, and the package outline form is also added.
 - But there is no change for a footprint.
- Change of ordering Part Number:
 - The products which are changed the bonding wire from Gold (Au) to Copper (Cu) are changed the ordering Part Number as follows.
 - Current part number: R5F1*****#V0, R5F1*****#X0
 - New part number: R5F1*****#30, R5F1*****#50
- Change of marking: Changes at assembly factory
- Packing specification: A part of Packing material is changed
- Storage conditions after opening the moistureproof packaging of ASEKH products:
 - Current: 30°C/70%RH/168hr
 - New: 30°C/60%RH/168hr (Confirming to the JEDEC standard)
- Specification and characteristics of product : No change
- Quality and reliability : No change

Appendix 3: Change Details (cont.)

Difference of specification (Wire material change)

Item		Current	New
Assembly factory		RSKL	ASEKH
Sorting factory		RSKL	RSB / KYEC
Package	Outline	Change (Refer to pages 6 to 15)	
Lead frame	Material	No change	
	Inner pattern	Change (Refer to page 16)	
Die mount	Material	Ag epoxy paste B	Ag epoxy paste C
Bonding wire	Material	Au	Cu (Pd coating)
Resin	Material	Resin B-1 (halogen-free)	Resin C (halogen-free)
Plating	Material	No change	
Marking	Font	Change (Refer to page 17)	
	Digit number	Change (Refer to pages 18,19)	
Packing	Tray/ Emboss tape	Change (Refer to page 20)	

※ There is no impact on reliability and specification by material change.
 ※ The contents of PC-WRP-A001C are not included in the difference.

Difference of specification (No wire material change)

Item		Current	New
Assembly factory		RSKL	ASEKH
Sorting factory		RSKL	RSB / KYEC
Package	Outline	Change (Refer to pages 6 to 15)	
Lead frame	Material	No change	
	Inner pattern	Change (Refer to page 16)	
Die mount	Material	Ag epoxy paste B	Ag epoxy paste C
Bonding wire	Material	No change	
Resin	Material	Resin B-2 (halogen-free)	Resin C (halogen-free)
Plating	Material	No change	
Marking	Font	Change (Refer to page 17)	
	Digit number	Change (Refer to pages 18,19)	
Packing	Tray/ Emboss tape	Change (Refer to page 20)	

※ There is no impact on reliability and specification by material change.
 ※ The contents of PC-WRP-A001C are not included in the difference.

Appendix 3: Change Details (cont.)

Difference of Outline Dimension_14mm×14mm 100pin

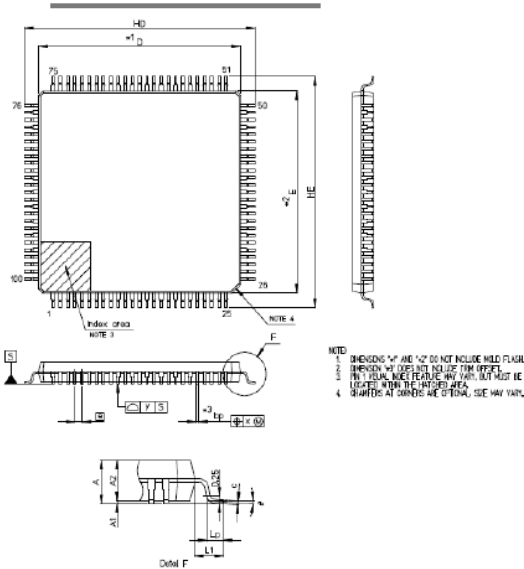

Symbol	Terminology	New	Current
D	Package length	14.0±0.1	14.00±0.20
E	Package width	14.0±0.1	14.00±0.20
A2	Package height	1.4	1.40±0.05
HD	Overall length	16.0±0.2	16.00±0.20
HE	Overall width	16.0±0.2	16.00±0.20
A	Seated height	1.70max	1.60max
A1	1st standoff height	0.05 to 0.15	0.10±0.05
bp	Terminal width	0.20 +0.07/-0.05	0.22±0.05
c	Terminal thickness	0.09 to 0.20	0.145 +0.055/-0.045
θ	Angle of terminal flat portions	3.5° +4.5°/-3.5°	3° +5°/-3°
e	Terminal pitch	0.5	0.50
x	Tolerance value of terminal center position	0.08max	0.08max
y	Coplanarity	0.08max	0.08max
Lp	Length of soldered part	0.60±0.15	0.60±0.15
L1	Terminal length	1.0	1.00±0.20

Difference of Appearance_14mm×14mm 100pin

※Character is reference example

	Package surface	Package back	Lead bending shape
New			
Current			

Appendix 3: Change Details (cont.)

Difference of Outline Dimension_12mm×12mm 80pin

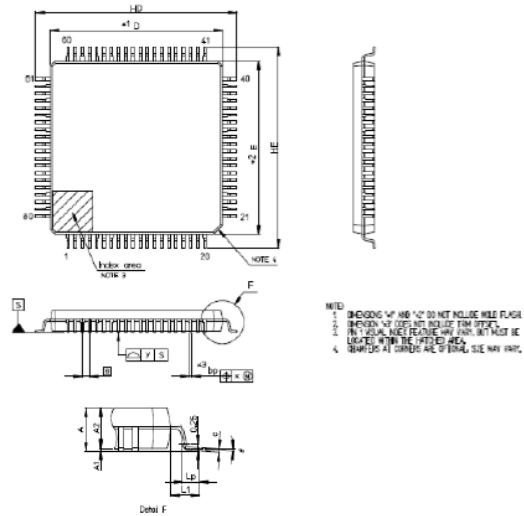

Symbol	Terminology	New	Current
D	Package length	12.0±0.1	12.00±0.20
E	Package width	12.0±0.1	12.00±0.20
A2	Package height	1.4	1.40±0.05
HD	Overall length	14.0±0.2	14.00±0.20
HE	Overall width	14.0±0.2	14.00±0.20
A	Seated height	1.70max	1.60max
A1	1st standoff height	0.05 to 0.15	0.10±0.05
bp	Terminal width	0.20 +0.07/-0.05	0.22±0.05
c	Terminal thickness	0.09 to 0.20	0.145 +0.055/-0.045
θ	Angle of terminal flat portions	3.5° +4.5°/-3.5°	3° +5°/-3°
e	Terminal pitch	0.5	0.50
x	Tolerance value of terminal center position	0.08max	0.08max
y	Coplanarity	0.08max	0.08max
Lp	Length of soldered part	0.60±0.15	0.60±0.15
L1	Terminal length	1.0	1.00±0.20

Difference of Appearance_12mm×12mm 80pin

※Character is reference example

	Package surface	Package back	Lead bending shape
New			
Current			

Appendix 3: Change Details (cont.)

Difference of Outline Dimension_10mm×10mm 64pin

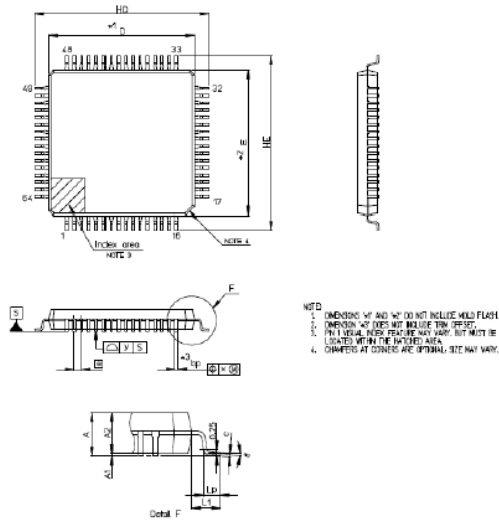

Symbol	Terminology	New	Current
D	Package length	10.0±0.1	10.00±0.20
E	Package width	10.0±0.1	10.00±0.20
A2	Package height	1.4	1.40±0.05
HD	Overall length	12.0±0.2	12.00±0.20
HE	Overall width	12.0±0.2	12.00±0.20
A	Seated height	1.70max	1.60max
A1	1st standoff height	0.05 to 0.15	0.10±0.05
bp	Terminal width	0.20 +0.07/-0.05	0.22±0.05
c	Terminal thickness	0.09 to 0.20	0.145 +0.055/-0.045
θ	Angle of terminal flat portions	3.5° +4.5°/-3.5°	3° +5°/-3°
e	Terminal pitch	0.5	0.50
x	Tolerance value of terminal center position	0.08max	0.08max
y	Coplanarity	0.08max	0.08max
Lp	Length of soldered part	0.60±0.15	0.60±0.15
L1	Terminal length	1.0	1.00±0.20

Difference of Appearance_10mm×10mm 64pin

※Character is reference example

	Package surface	Package back	Lead bending shape
New			
Current			

Appendix 3: Change Details (cont.)

Difference of Outline Dimension_10mm×10mm 44pin

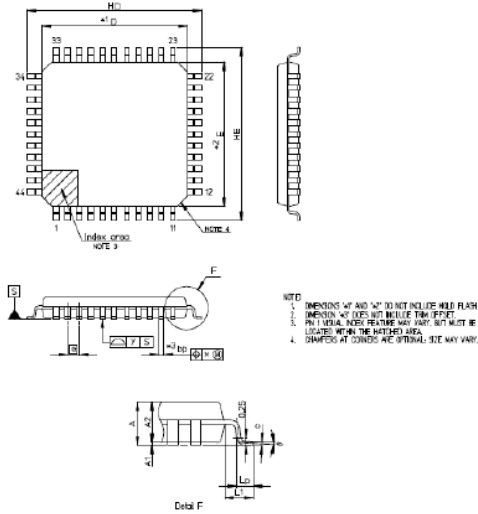

Symbol	Terminology	New	Current
D	Package length	10.0±0.2	10.00±0.20
E	Package width	10.0±0.2	10.00±0.20
A2	Package height	1.4	1.40±0.05
HD	Overall length	12.0±0.2	12.00±0.20
HE	Overall width	12.0±0.2	12.00±0.20
A	Seated height	1.70max	1.60max
A1	1st standoff height	0.05 to 0.15	0.10±0.05
bp	Terminal width	0.37 +0.08/-0.15	0.37 +0.08/-0.07
c	Terminal thickness	0.09 to 0.20	0.145 +0.055/-0.045
θ	Angle of terminal flat portions	3.5° +4.5°/-3.5°	3° +5°/-3°
e	Terminal pitch	0.8	0.80
x	Tolerance value of terminal center position	0.20max	0.20max
y	Coplanarity	0.10max	0.10max
Lp	Length of soldered part	0.60±0.15	0.60±0.15
L1	Terminal length	1.0	1.00±0.20

Difference of Appearance_10mm×10mm 44pin

※Character is reference example

	Package surface	Package back	Lead bending shape
New			
Current			

Appendix 3: Change Details (cont.)

Difference of Outline Dimension_7mm×7mm 48pin

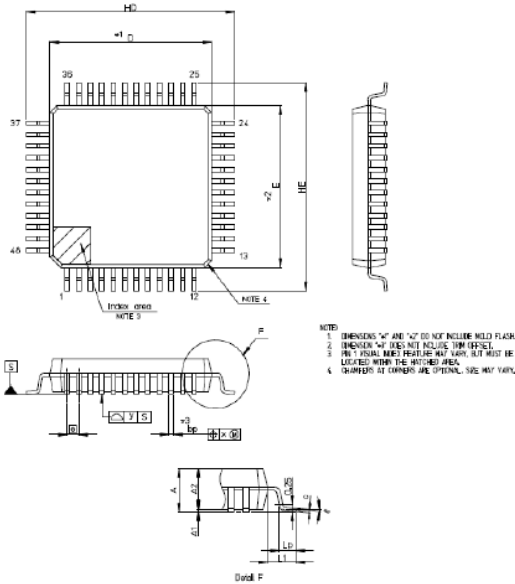

Symbol	Terminology	New	Current
D	Package length	7.0±0.1	7.00±0.20
E	Package width	7.0±0.1	7.00±0.20
A2	Package height	1.4	1.40±0.05
HD	Overall length	9.0±0.2	9.00±0.20
HE	Overall width	9.0±0.2	9.00±0.20
A	Seated height	1.70max	1.60max
A1	1st standoff height	0.05 to 0.15	0.10±0.05
bp	Terminal width	0.20 +0.07/-0.03	0.22±0.05
c	Terminal thickness	0.09 to 0.20	0.145 +0.055/-0.045
θ	Angle of terminal flat portions	3.5° +4.5°/-3.5°	3° +5°/-3°
e	Terminal pitch	0.5	0.50
x	Tolerance value of terminal center position	0.08max	0.08max
y	Coplanarity	0.08max	0.08max
Lp	Length of soldered part	0.60±0.15	0.60±0.15
L1	Terminal length	1.0	1.00±0.20

Difference of Appearance_7mm×7mm 48pin





※Character is reference example

	Package surface	Package back	Lead bending shape
New			
Current			

Appendix 3: Change Details (cont.)

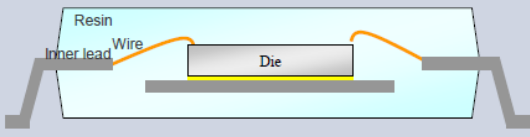
PKG structure image

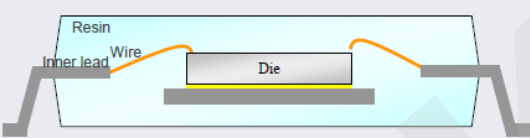

※ PKG cross section and die pad shape are reference examples

Assembly Line	PKG cross section	Die pad shape
New		
Current		

※ There is no impact on the reliability by die pad shape

Difference of Marking Visibility

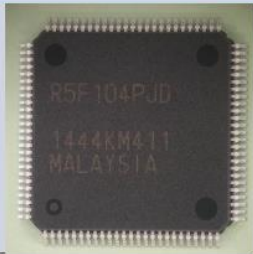
※ Character is reference example

Assembly Line	New	Current
Whole Photo		
Detail Photo		

Appendix 3: Change Details (cont.)

Difference of marking

	Current		New	
48pin	XXXXXX YYYYYYYY •	→	XXXXXX YYYYYYY •	X : Part number : No change (6-digit) Y : Lot number : Change (9 → 7-digit)
44/64pin	XXXXXXXXXX YYYYYYYYY •	→	XXXXXXXXXX YYYYYYY •	X : Part number : No change (9-digit) Y : Lot number : Change (9 → 7-digit)
80pin	XXXXXXXXXX YYYYYYYYY ZZZZZZZ •	→	XXXXXXXXXX YYYYYYY •	X : Part number : No change (9-digit) Y : Lot number : Change (9 → 7-digit) Z : Country of origin : Change (8-digit → Non)
100pin	XXXXXXXXXX YYYYYYYYY ZZZZZZZ •	→	XXXXXXXXXX YYYYYYY •	X : Part number : No change (9-digit) Y : Lot number : Change (9 → 7-digit) Z : Country of origin : Change (8-digit → Non)

Difference of marking

	Current		New	
48pin	XXXXX YYYYYYYY CCC •	→	XXXXX YYYYYYY CCC •	X : Part number : No change (5-digit) Y : Lot number : Change (9 → 7-digit) C : ROM code : No change (3-digit)
44/64pin	XXXXXXXXXX CCC YYYYYYYYY •	→	CCC XXXXXXXXXX YYYYYYY •	X : Part number : Change (Line change) Digit isn't change C : ROM code : Change (Line change) Digit isn't change Y : Lot number : Change (9 → 7-digit)
80pin	XXXXXXXXXX CCC YYYYYYYYY ZZZZZZZ •	→	XXXXXXXXXX CCC YYYYYYY •	X : Part number : No change (8-digit) C : ROM code : No change (3-digit) Y : Lot number : Change (9 → 7-digit) Z : Country of origin : Change (8-digit → Non)
100pin	XXXXXXXXXX CCC YYYYYYYYY ZZZZZZZ •	→	XXXXXXXXXX CCC YYYYYYY •	X : Part number : No change (8-digit) C : ROM code : No change (3-digit) Y : Lot number : Change (9 → 7-digit) Z : Country of origin : Change (8-digit → Non)

Appendix 3: Change Details (cont.)

PACKING SPECIFICATION (Embossed tape)

Storage number:

Only 10mm x 10mm 64pin LQFP embossed tape will be changed. Other packages are unchanged.

	RSKL	RSB
Ordering Part Number	R5F1*RL**FB#X0	R5F1*RL**FB#50
Embossed tape code	E2416Q10RA	←
Storage number	1000 pcs/reel	1500 pcs/reel

Change of desiccant:

Desiccant of embossed tape packing is different with RSKL and RSB/KYEC.

However, there is no change in the storage term.

	RSKL	RSB/KYEC
Desiccant		

4M changing points

(Addition of assembly and sorting factory , Change of material)
(Wire material change; Au->Cu)

Item	Check Result	judgement
Machine	Changing at assembly and sorting. The machines are equivalent to present machines. Copper wire products are produced by same wire-bonding machine applied gold wire. To prevent copper wire oxidization, inert gas is used to wire-bonding process. There are production of similar copper wire products and we have already checked the additional products have no risk on the production.	No risk
Method	Bonding method (thermosonic bonding) and process flow for the Cu wiring are same as the Au wiring.	No risk
Man	Using operator certification system. Only certificated operator can work for the production.	No risk
Material	Using only certificated copper wire. And furthermore certificated materials for the Cu wiring products are applied. The products has been certificated by reliability test same as gold wire products and have no risk.	No risk

Appendix 3: Change Details (cont.)

4M changing points

(Addition of assembly and sorting factory , Change of material)
 (No wire material change; Cu)

Item	Check Result	judgement
Machine	Changing at assembly and sorting. The machines are equivalent to present machines. Copper wire products are produced by same wire-bonding machine applied gold wire. To prevent copper wire oxidization, inert gas is used to wire-bonding process. There are production of similar copper wire products and we have already checked the additional products have no risk on the production.	No risk
Method	The same as current products.	No risk
Man	Using operator certification system. Only certificated operator can work for the production.	No risk
Material	Using only certificated copper wire. And furthermore certificated materials for the Cu wiring products are applied. The products has been certificated by reliability test same as gold wire products and have no risk.	No risk