

PART NUMBER	SML-LX0303SIUPGUSB	REV	A
REV	E.C.N. NUMBER AND REVISION COMMENTS	DATE	
A	ECN-Lumex201800052	04.02.18	

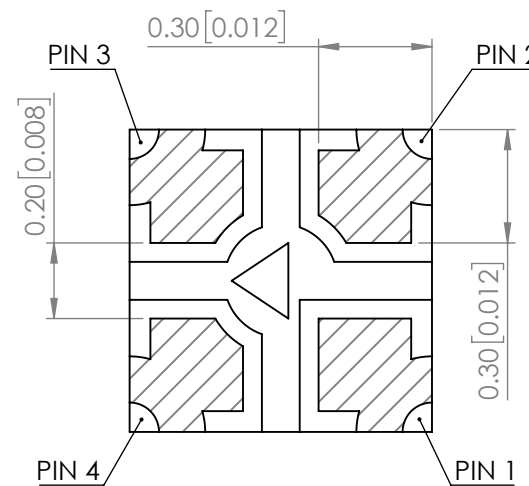

POLARITY

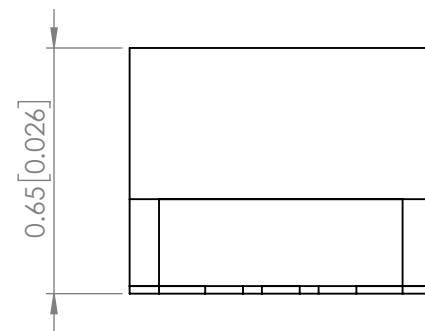
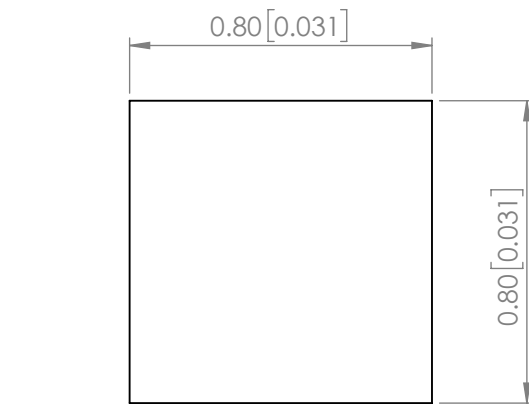
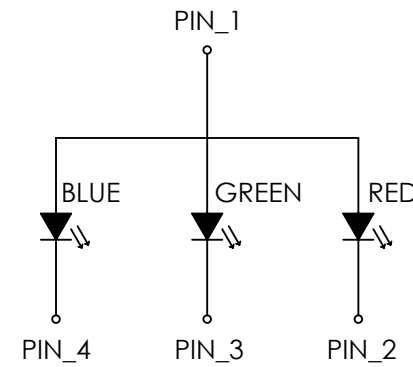

RECOMMENDED SOLDER PAD LAYOUT

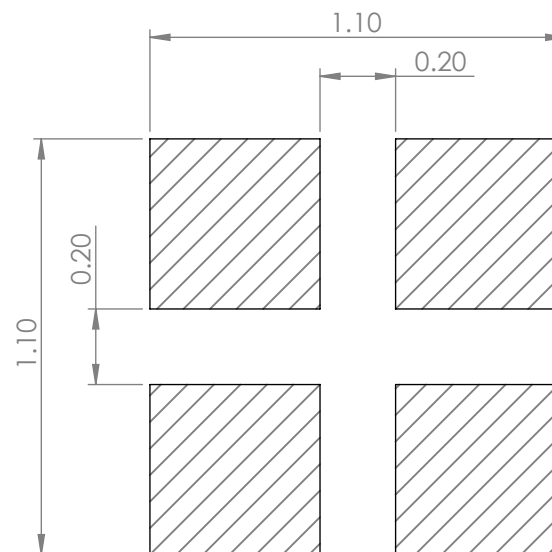

ELECTRO-OPTICAL CHARACTERISTIC TA=25°C

PARAMETER		MIN	TYP	MAX	UNITS	TEST COND
PEAK WAVELENGTH	R	-	625	-	nm	If=3mA
	G	-	525	-		If=5mA
	B	-	465	-		If=5mA
FORWARD VOLTAGE	R	-	2.0	2.4	Vf	If=3mA
	G	-	2.9	3.2		If=5mA
	B	-	2.9	3.2		If=5mA
REVERSE CURRENT		-	-	10	uA	VR=5V
LUMINOUS INTENSITY	R	12	-	20	mcd	If=3mA
	G	61	-	104		If=5mA
	B	9	-	25		If=5mA
VIEWING ANGLE		-	120	-	2x theta1/2	-
EMITTED COLOR		R/G/B				
EPOXY LENS FINISH		CLEAR LENS (TINTED) WITH TEXTURED FINISH TOP				

ABSOLUTE MAXIMUM RATINGS TA=25°C

PARAMETER	MAX	UNITS
PEAK FORWARD CURRENT (R/G/B)*	20 / 20 / 20	mA
FORWARD CURRENT (R/G/B)	10 / 10 / 10	mA
REVERSE VOLTAGE	5	V
POWER DISSIPATION (R/G/B)	24 / 31 / 31	mW
STORAGE TEMPERATURE	-40 TO +90	°C
OPERATING TEMPERATURE	-40 TO +85	°C
SOLDERING TEMPERATURE	3 SEC. MAX @ 260	°C

*t<10us

NOTE:

1. RoHS COMPLIANT.
2. COMPLIANCE WITH EU REACH.
3. COMPLIANCE HALOGEN FREE .
(Br <900 ppm ,Cl <900 ppm , Br+Cl < 1500 ppm).

*UNLESS OTHERWISE SPECIFIED TOLERANCES PER DECIMAL PRECISION ARE: X=±1 (±0.039), X.X=±0.5 (±0.020), X.XX=±0.25 (±0.010), X.XXX=±0.127 (±0.005). LEAD SIZE=±0.05 (±0.002), LEAD LENGTH=±0.75 (±0.030). MIN= ^{+DECIMAL PRECISION} / _{-0.00} MAX= ^{+0.00} / _{-DECIMAL PRECISION}

PROFILE

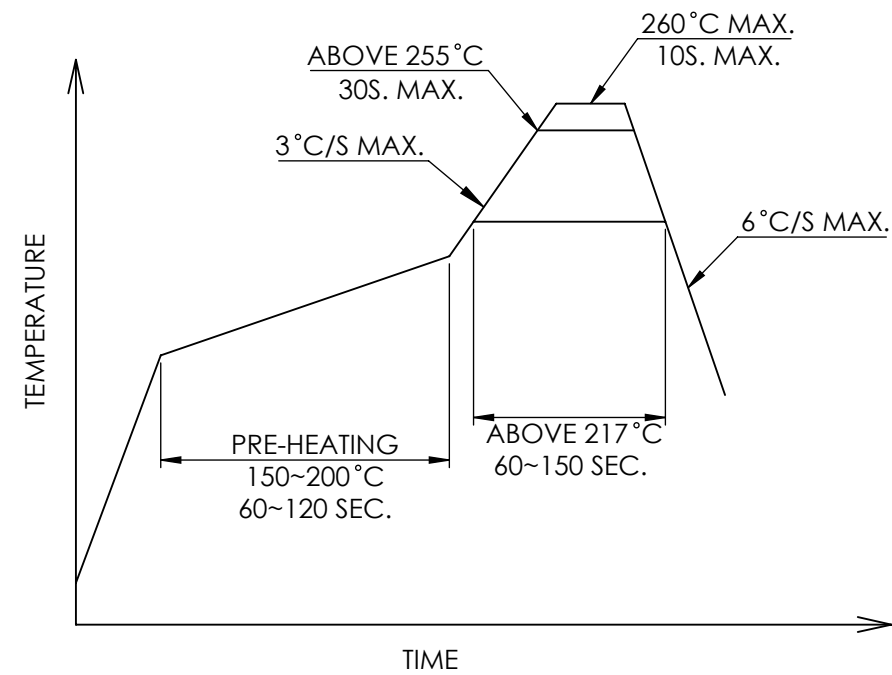

CARRIER TAPE DIMENSION

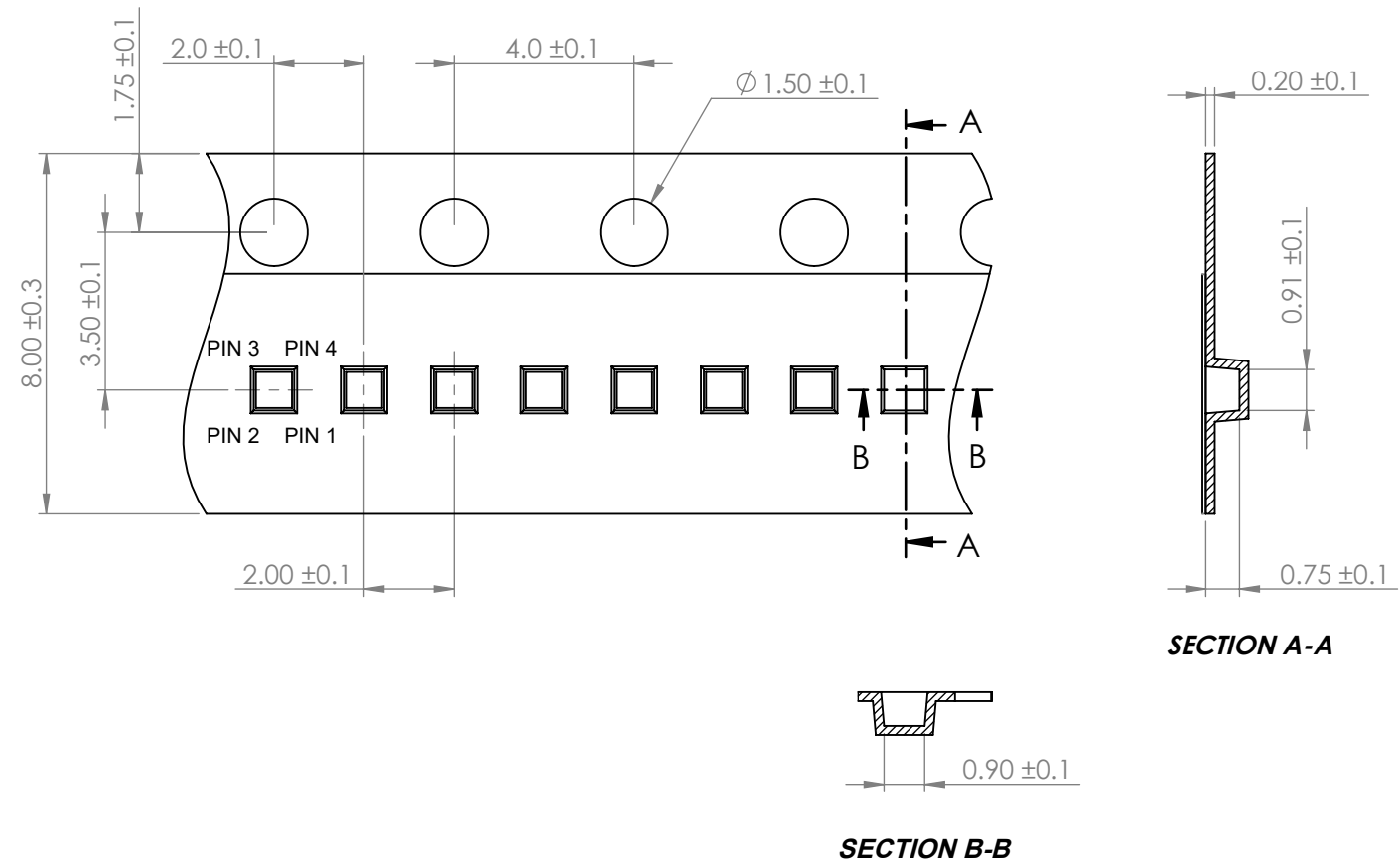

*UNLESS OTHERWISE SPECIFIED TOLERANCES PER DECIMAL PRECISION ARE: X=±1 (±0.039), X.X=±0.5 (±0.020), X.XX=±0.25 (±0.010), X.XXX=±0.127 (±0.005). LEAD SIZE=±0.05 (±0.002), LEAD LENGTH=±0.75 (±0.030). MIN= ^{+DECIMAL PRECISION}/_{-0.00} MAX.= ^{+0.00}/_{-DECIMAL PRECISION}

<p>425 N. GARY AVE. CAROL STREAM, IL 60188 PHONE : 800-278-5666 FAX : 630-315-2150 WEB : WWW.LUMEX.COM</p>	0.8(L)*0.8(W)*0.65(H)mm,SURFACE MOUNT LED,AIGaInp RED / InGaN GREEN / InGaN BLUE LED,CLEAR LENS (TINTED) WITH TEXTURED FINISH TOP,COMMON ANODE,TAPE & REEL	DATE : 2018.04.02	DRAWN BY : C.C.	
	THE SPECIFICATIONS MAY CHANGE AT ANY TIME WITHOUT NOTICE DUE TO NEW MATERIALS OR PRODUCT IMPROVEMENT.	PAGE : 2 OF 2	CHKD BY : E.C.	
	CONFIDENTIAL INFORMATION THE INFORMATION CONTAINED IN THIS DOCUMENT IS THE PROPERTY OF LUMEX INC. EXCEPT AS SPECIFICALLY AUTHORIZED IN WRITING BY LUMEX INC., THE HOLDER OF THIS DOCUMENT SHALL KEEP ALL INFORMATION CONTAINED HEREIN CONFIDENTIAL AND SHALL PROTECT SAME IN WHOLE OR IN PART FROM DISCLOSURE AND DISSEMINATION TO ALL THIRD PARTIES.	SCALE : NTF	APRVD BY : G.Y.	
		UNIT : mm [INCH]	(Pb)	