

Recommended FFC/FPC Dimensions

Left Footprint Version

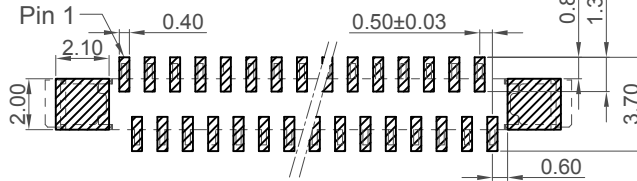
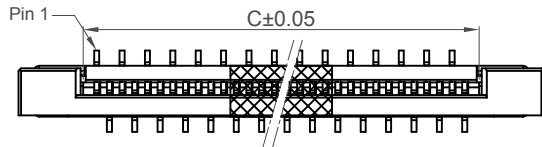

Recommended PCB Layout

General Tolerance ±0.05

▨ Solder Area □ Component Outline

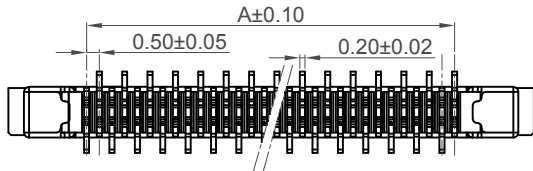

Right Footprint Version (Standard)

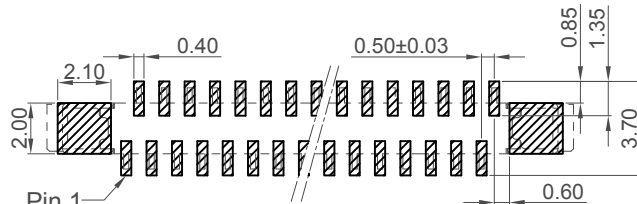
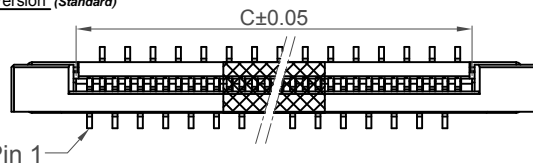

Recommended PCB Layout

General Tolerance ±0.05

▨ Solder Area □ Component Outline

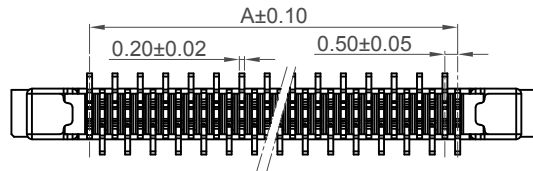

Specifications

Material

Housing: PA6T,UL 94V-0, Natural
 Actuator: PPS,UL 94V-0, Brown
 Contact: Phosphor Bronze,C5191R-H
 Fitting Nail: Brass,C2680R-H

Plating

Contact: see ordering grid
 Fitting Nail: Matte Tin over Nickel

Electrical

Voltage Rating: 30V
 Current Rating : 0.2A
 Dielectric Strength: 250V AC for 1 minute
 Insulation Resistance: 50 MΩ Min.
 Contact Resistance: 40 mΩ Max.

Mechanical & Environmental

Durability: 20 Cycles
 Operating Temperature: -25°C to +85°C
 Solder Profile:
 Peak Temp 260°C (+0/-5°C) max. (5 seconds)

No. of Contacts	Dimensions			
	A	B	C	D
4	1.50	7.7	2.60	6.00
* 5	2.00	8.2	3.10	
* 6	2.50	8.7	3.60	
* 7	3.00	9.2	4.10	
* 8	3.50	9.7	4.60	
* 9	4.00	10.2	5.10	
* 10	4.50	10.7	5.60	
* 11	5.00	11.2	6.10	
* 12	5.50	11.7	6.60	
* 13	6.00	12.2	7.10	
* 14	6.50	12.7	7.60	
* 15	7.00	13.2	8.10	
* 16	7.50	13.7	8.60	
* 17	8.00	14.2	9.10	
* 18	8.50	14.7	9.60	
* 19	9.00	15.2	10.10	
* 20	9.50	15.7	10.60	
* 21	10.00	16.2	11.10	
* 22	10.50	16.7	11.60	
* 23	11.00	17.2	12.10	
* 24	11.50	17.7	12.60	
* 25	12.00	18.2	13.10	
* 26	12.50	18.7	13.60	
* 27	13.00	19.2	14.10	
* 28	13.50	19.7	14.60	
* 29	14.00	20.2	15.10	
* 30	14.50	20.7	15.60	
* 31	15.00	21.2	16.10	
* 32	15.50	21.7	16.60	
* 33	16.00	22.2	17.10	
* 34	16.50	22.7	17.60	
* 35	17.00	23.2	18.10	
* 36	17.50	23.7	18.60	
* 37	18.00	24.2	19.10	
* 38	18.50	24.7	19.60	
* 39	19.00	25.2	20.10	
* 40	19.50	25.7	20.60	
41	20.00	26.2	21.10	
42	20.50	26.7	21.60	
43	21.00	27.2	22.10	
44	21.50	27.7	22.60	
45	22.00	28.2	23.10	
46	22.50	28.7	23.60	
47	23.00	29.2	24.10	
48	23.50	29.7	24.60	
49	24.00	30.2	25.10	
50	24.50	30.7	25.60	
51	25.00	31.2	26.10	
52	25.50	31.7	26.60	
53	26.00	32.2	27.10	
54	26.50	32.7	27.60	
55	27.00	33.2	28.10	
56	27.50	33.7	28.60	
57	28.00	34.2	29.10	
58	28.50	34.7	29.60	
59	29.00	35.2	30.10	
60	29.50	35.7	30.60	

*= Toolled Parts
 Please contact GCT for non-tooled parts

Ordering Grid

FFC2A33-XX-X-X Request samples and quotation

No. of Contacts: 04 - 60 (see dimension table)

Contact Footprint: R=Right (Standard), L=Left

Contact Plating: T=Tin Plating over all (Standard), G=Gold Flash over all

Part Number		Product Description	
FFC2A33		FPC 0.5mm Pitch Top Entry,SMT, Left or Righth Footprint, Height=4.50mm,ZIF,Slide Type	
Drawing Date		18th November 2019	
By	CC	Tolerances (Except as Noted)	Units:
Detail	Drawing Release	Length X. ± 0.50 X.X ± 0.30 X.XX ± 0.20 X.XXX ± 0.10	Metric (mm)
Revision	A1	Angle ± 0.5°	3rd Angle Projection
Date	10/08/20		



This drawing is confidential and copyright of Global Connector Technology, Ltd (GCT). This drawing must not be copied or disclosed without written consent. E & OE



Not to Scale	Drawn By CC	Sheet No. 1/2
--------------	-------------	---------------

H
G
F
E
D
C
B
A

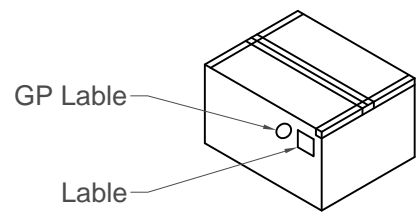
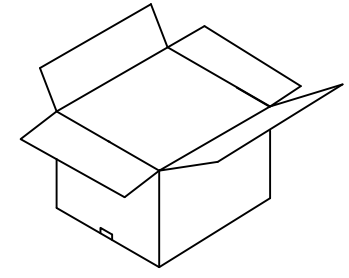
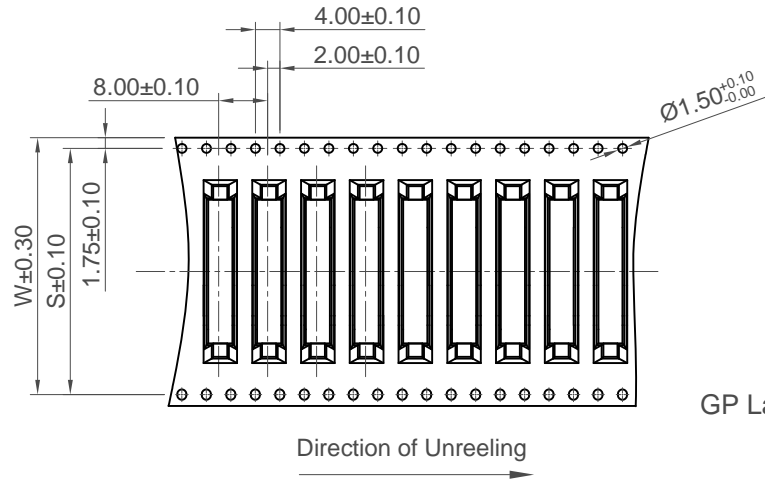
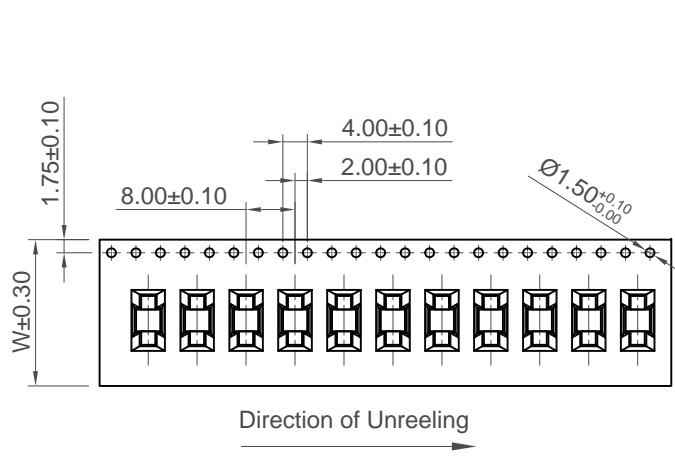
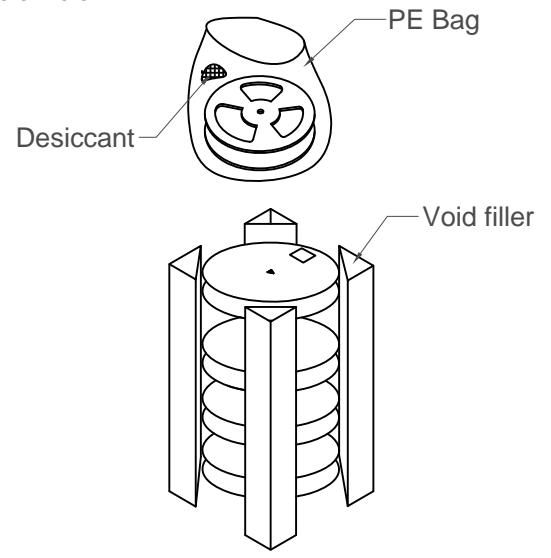
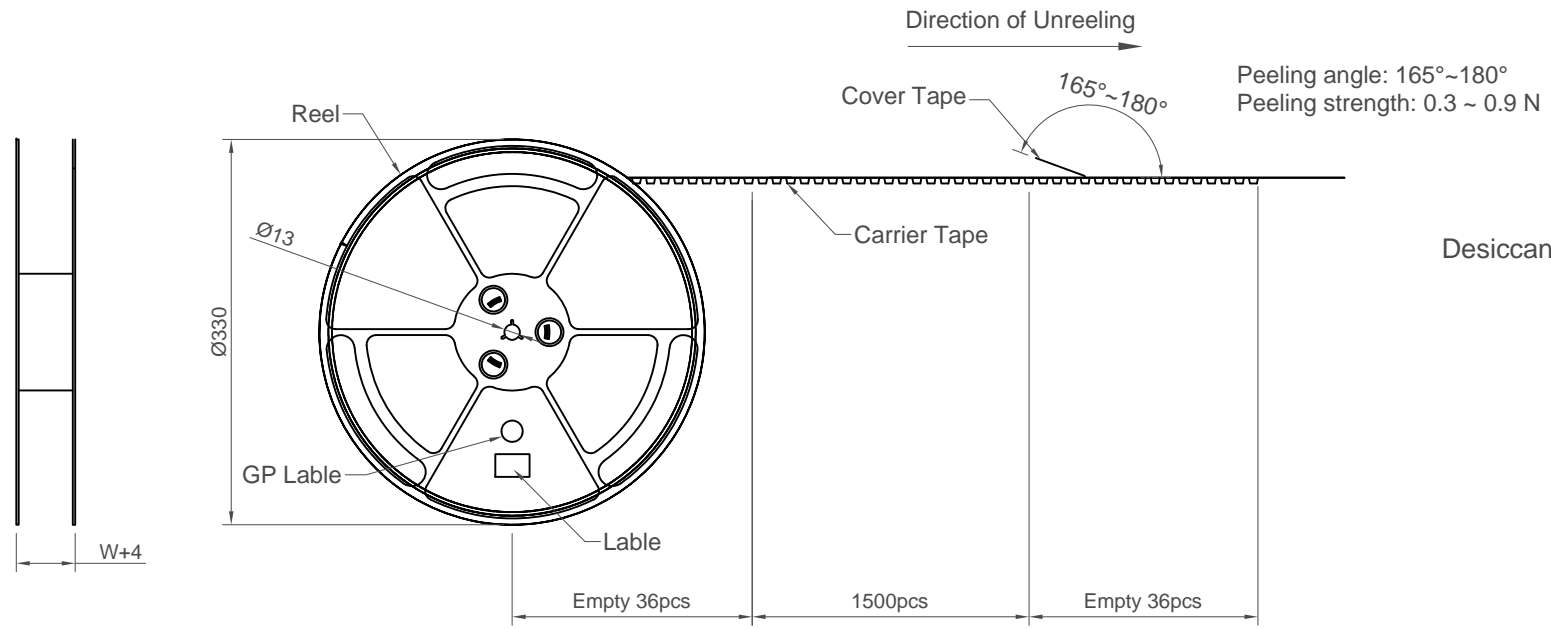

No. of Contacts	W	S	Pcs/Reel	Reel/Carton	Pcs/Carton
4 ~ 20	24	/	1500	10	15000
21 ~ 30	32	28.4	1500	8	12000
31 ~ 50	44	40.4	1500	6	9000
51 ~ 60	56	52.4	1500	4	6000

Part Number		Product Description	
FFC2A33		FPC 0,5mm Pitch Top Entry, SMT, Left or Righth Footprint, Height=4.50mm, ZIF, Slide Type	
Drawing Date		18th November 2019	
By	CC	Tolerances (Except as Noted)	Units:
Detail	Drawing Release	Length	Metric (mm)
Revision	A1	Angle	3rd Angle Projection
Date	10/08/20		



This drawing is confidential and copyright of Global Connector Technology, Ltd (GCT). This drawing must not be copied or disclosed without written consent. E & OE



Not to Scale	Drawn By CC	Sheet No. 2/2
--------------	----------------	------------------

1 2 3 4 5 6 7 8