

# POLYZEN DEVICES

## Polymer Protected Zener Diode

PolyZen devices are polymer-enhanced, precision Zener diodes. They offer resettable protection against multi-Watt fault events without the need for multi-Watt heat sinks.

The Zener diode used for voltage clamping a PolyZen device was selected due to its relatively flat voltage vs. current response. This helps improve output voltage clamping, even when input voltage is high and diode currents are large.

An advanced feature of the PolyZen device is that the Zener diode is thermally coupled to a resistively non-linear, PPTC (polymer positive temperature coefficient) layer. This PPTC layer is fully integrated into the device and is electrically in series between  $V_{IN}$  and the diode clamped  $V_{OUT}$ .

This advanced PPTC layer responds to either extended diode heating or overcurrent events by transitioning from a low to high resistance state, also known as “tripping.” A tripped PPTC will limit current and generate voltage drop. It helps to protect both the Zener diode and the follow-on electronics and effectively increases the diode’s power handling capability.

The polymer-enhanced Zener diode helps protect sensitive portable electronics from damage caused by inductive voltage spikes, voltage transients, incorrect power supplies and reverse bias. These devices are particularly suitable for portable electronics and other low-power DC devices.

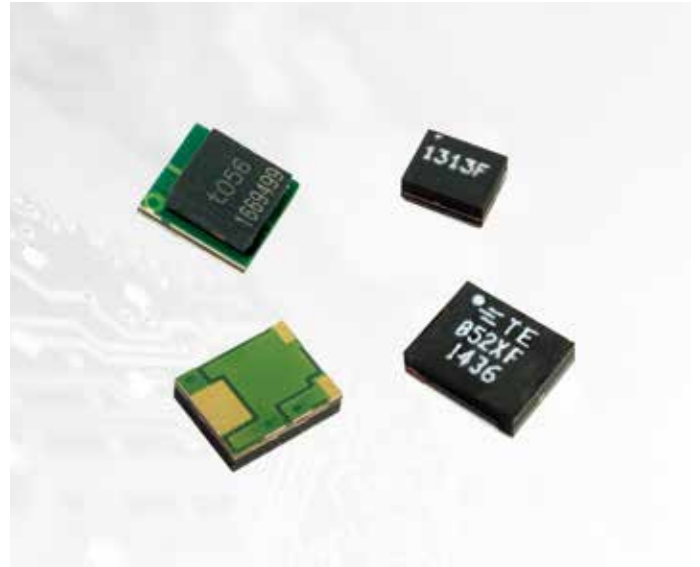

### BENEFITS

- Stable Zener diode helps shield downstream electronics from overvoltage and reverse bias
- Trip events shut out overvoltage and reverse bias sources
- Analog nature of trip events helps minimize damage from upstream inductive spikes
- Minimal power dissipation requirements
- Single component placement

### FEATURES

- Overvoltage transient suppression
- Stable  $V_Z$  vs. fault current
- Time delayed, overvoltage trip
- Time delayed, reverse bias trip

### APPLICATIONS

- DC power port protection in portable electronics
- DC power port protection for systems using barrel jacks for power input
- Internal overvoltage and transient suppression
- DC output voltage regulation
- Tablet PCs and portable electronics

- Multi-Watt power handling capability
- Integrated device construction
- RoHS compliant
- Halogen free  
(refers to: Br≤900ppm, Cl≤900ppm, Br+Cl≤1500ppm)

## Figure PZ1 – Typical Application Block Diagram

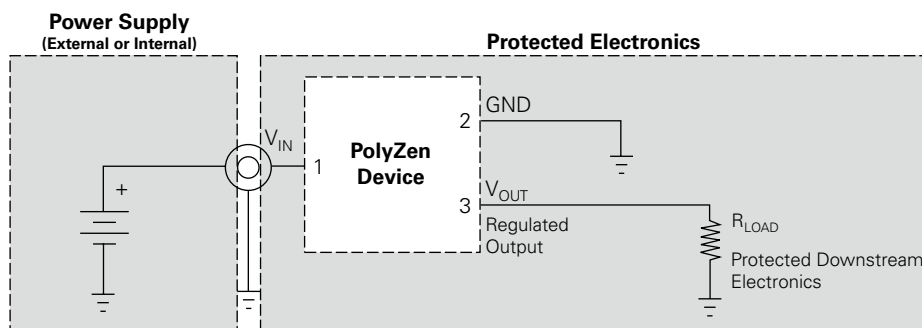

## Table PZ1 – Electrical Characteristics

(Performance ratings @ 25°C unless otherwise specified)

Part Number	$V_Z$ (V)			$I_{ZT}$ (A)	$I_{HOLD}$ @ 20°C (A)	$R_{TYP}$ ( $\Omega$ )	$R_{1MAX}$ ( $\Omega$ )	$V_{INT MAX}$		$I_{FLT MAX}$	
	Min	Typ	Max					$V_{INT MAX}$ (V)	Test Current (A)	$I_{FLT MAX}$ (A)	Test Voltage (V)
ZEN056V130A24LS	5.45	5.60	5.75	0.10	1.30	0.12	0.16	24	3	+10/-40	+24/-16
ZEN059V130A24LS†	5.80	5.90	6.00	0.10	1.30	0.12	0.15	24	3	+6/-40	+24/-16
ZEN065V130A24LS	6.35	6.50	6.65	0.10	1.30	0.12	0.16	24	3	+6/-40	+24/-16
ZEN098V130A24LS	9.60	9.80	10.00	0.10	1.30	0.12	0.16	24	3	+3.5/-40	+24/-16
ZEN132V130A24LS	13.20	13.40	13.60	0.10	1.30	0.12	0.16	24	3	+2/-40	+24/-16
ZEN164V130A24LS	16.10	16.40	16.60	0.10	1.30	0.12	0.16	24	3	+1.25/-40	+24/-16
ZEN056V230A16LS	5.45	5.60	5.75	0.10	2.30	0.04	0.06	16	5	+5/-40	+16/-12
ZEN065V230A16LS	6.35	6.50	6.65	0.10	2.30	0.04	0.06	16	5	+3.5/-40	+16/-12
ZEN098V230A16LS	9.60	9.80	10.00	0.10	2.30	0.04	0.06	16	5	+3.5/-40	+16/-12
ZEN132V230A16LS	13.20	13.40	13.60	0.10	2.30	0.04	0.06	16	5	+2/-40	+20/-12
ZEN056V075A48LS	5.45	5.60	5.75	0.10	0.75	0.28	0.45	48	3	+10/-40	+48/-16
ZEN132V075A48LS	13.20	13.40	13.60	0.10	0.75	0.28	0.45	48	3	+2/-40	+48/-16
ZEN056V115A24LS	5.45	5.60	5.75	0.10	1.15	0.15	0.18	24	3	+10/-40	+24/-16
NEW ZEN056V130A16YM	5.35	5.60	5.85	0.10	1.30	0.110	0.160	14	3	+3/-40	+16/-12
NEW ZEN056V175A12YM	5.35	5.60	5.85	0.10	1.75	0.050	0.095	12	4	+3/-40	+12/-12
NEW ZEN132V130A16YM	13.20	13.40	13.80	0.10	1.30	0.110	0.160	14	3	+1/-40	+20/-12
NEW ZEN132V175A12YM	13.20	13.40	13.80	0.10	1.75	0.050	0.095	12	4	+1/-40	+20/-12
NEW ZEN056V130A24YC	5.35	5.60	5.85	0.10	1.30	0.110	0.170	24	3	+4/-40	+24/-16
NEW ZEN056V230A16YC	5.35	5.60	5.85	0.10	2.30	0.040	0.070	16	5	+3/-40	+16/-12
NEW ZEN056V260A16YC	5.35	5.60	5.85	0.10	2.60	0.040	0.055	16	5	+3/-40	+16/-12
NEW ZEN132V130A24YC	13.20	13.40	13.80	0.10	1.30	0.110	0.170	24	3	+1/-40	+24/-16
NEW ZEN132V230A16YC	13.20	13.40	13.80	0.10	2.30	0.040	0.070	16	5	+1/-40	+20/-12
NEW ZEN132V260A16YC	13.20	13.40	13.80	0.10	2.60	0.040	0.055	16	5	+1/-40	+20/-12

LS module height is 1.7mm typical. YM module height is 1.2mm typical. YC module height is 1.3mm typical.

† Typical operating current is 500µA @ 5.0V which meets USB suspend mode requirement.

## Table PZ2 – Definition of Terms

$V_Z$	Zener clamping voltage measured at current $I_{ZT}$ and 20°C.
$I_{ZT}$	Test current at which $V_Z$ is measured.
$I_{HOLD}$	Maximum steady state current $I_{PTC}$ that will not generate a trip event at the specified temperature. Ratings assume $I_{FLT} = 0A$ .
$R_{TYP}$	Typical resistance between $V_{IN}$ and $V_{OUT}$ pins when the device is at room temperature.
$R_{1MAX}$	The maximum resistance between $V_{IN}$ and $V_{OUT}$ pins, at room temperature, one hour after first trip or after reflow soldering.
$I_{FLT}$	Current flowing through the Zener diode.
$I_{FLT MAX}$	Maximum RMS fault current the Zener diode component of the device can withstand and remain resettable; testing is conducted at rated voltage with no load connected to $V_{OUT}$ .
$V_{INT MAX}$	The voltage ( $V_{IN} - V_{OUT}$ "post trip") at which typical qualification devices (98% devices, 95% confidence) survived at least 100 trip cycles and 24 hours trip endurance when "tripped" at the specified voltage and current ( $I_{PTC}$ ).
$I_{PTC}$	Current flowing through the PPTC portion of the circuit.
$I_{OUT}$	Current flowing out the $V_{OUT}$ pin of the device.
Trip Event	A condition where the PPTC transitions to a high resistance state, thereby limiting $I_{PTC}$ , and significantly increasing the voltage drop between $V_{IN}$ and $V_{OUT}$ .

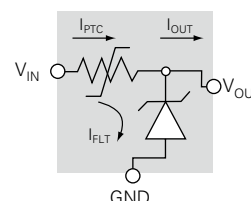
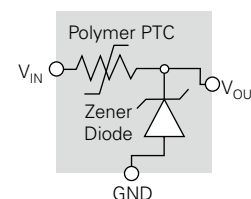

## Figures PZ2-PZ9 – Typical Performance Curves for PolyZen Devices - LS Series

**Figure PZ2**

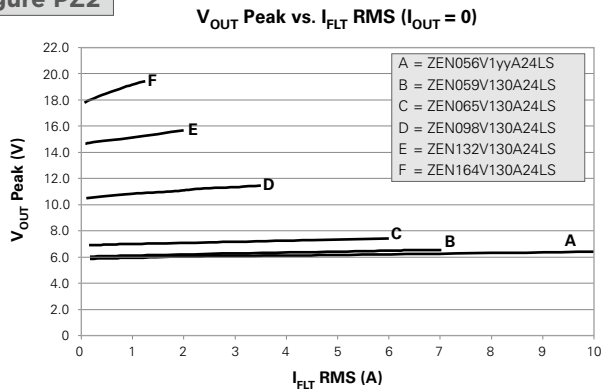

**Figure PZ3**

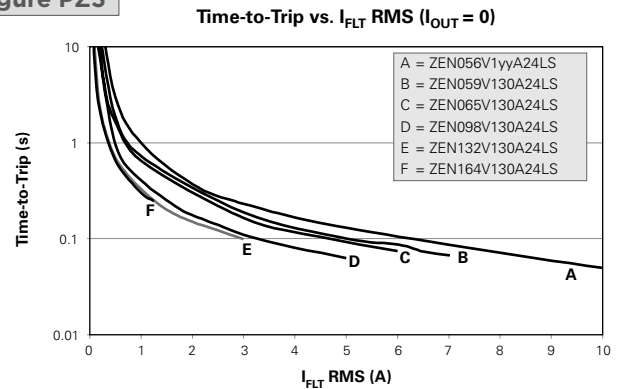

**Figure PZ4**

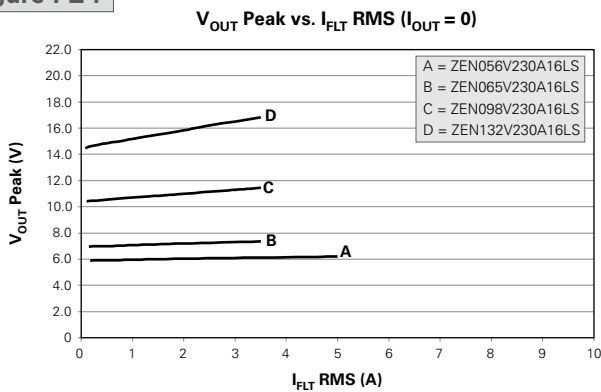

**Figure PZ5**

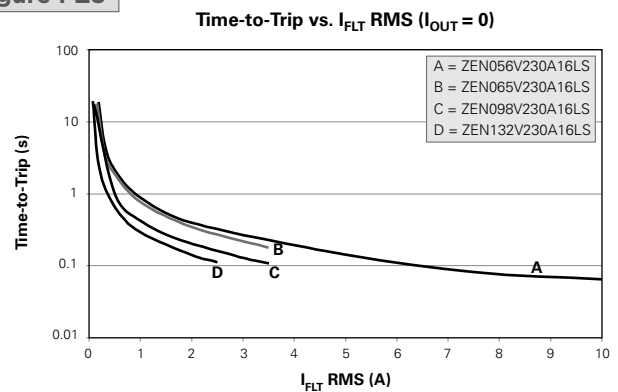

**Figure PZ6**

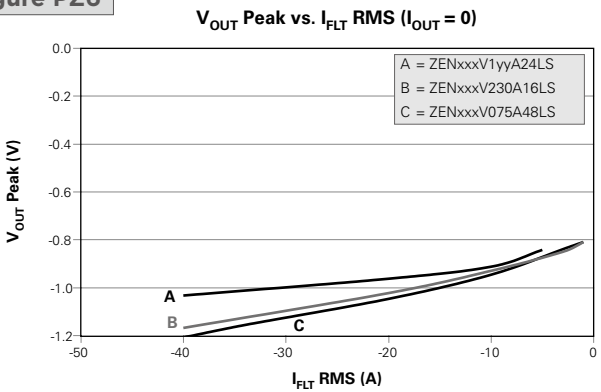

**Figure PZ7**

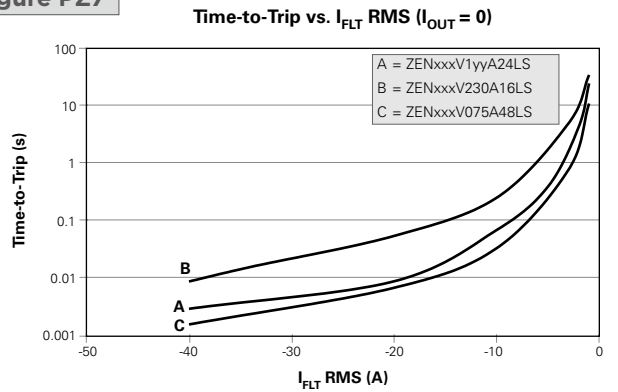

**Figure PZ8**

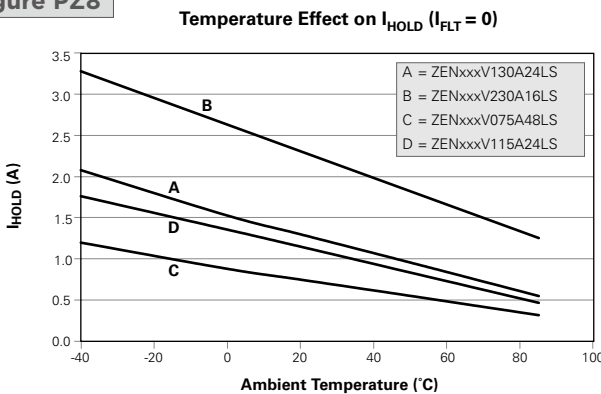

**Figure PZ9**

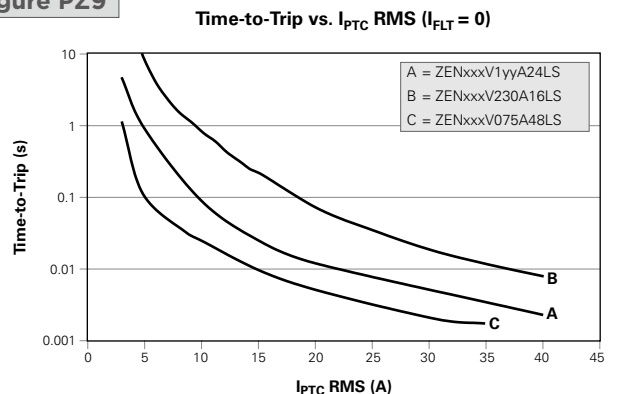

## Figures PZ10-PZ15 — Typical Performance Curves for PolyZen Devices - YM Series

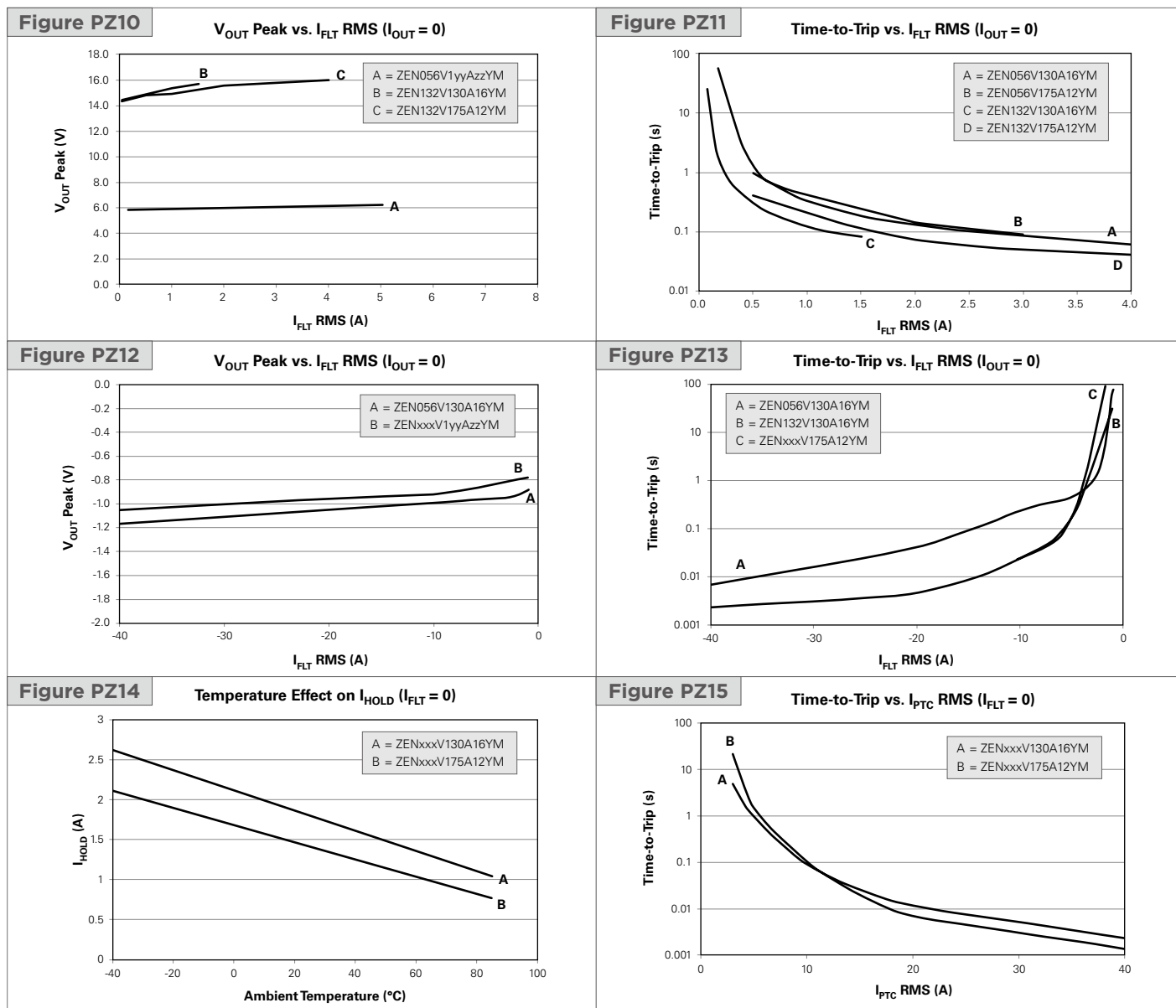

## Figures PZ16-PZ21 — Typical Performance Curves for PolyZen Devices - YC Series

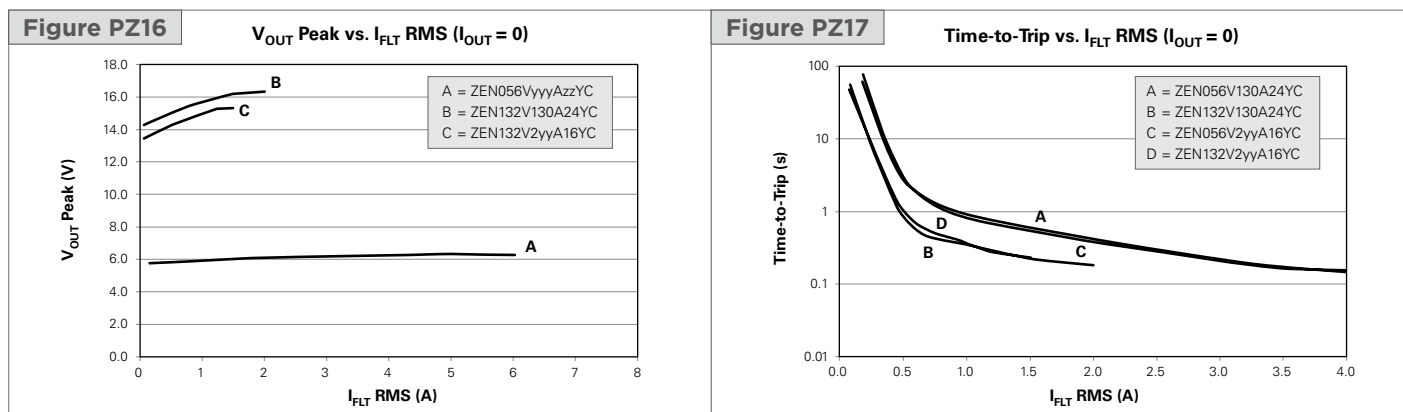

# 4 PolyZen Devices Polymer Protected Zener Diode

## Figures PZ16-PZ21 — Typical Performance Curves for PolyZen Devices - YC Series (Cont'd)

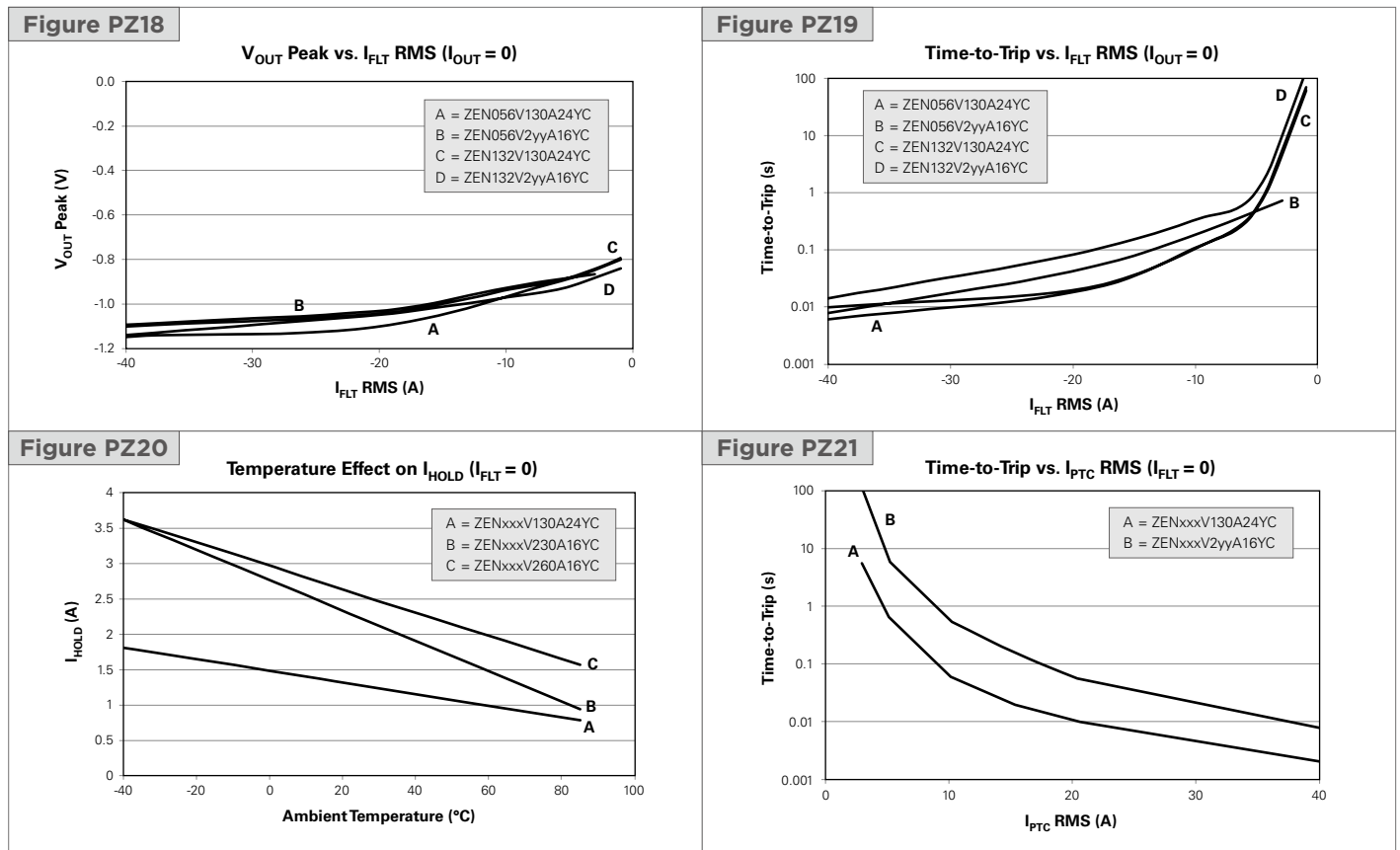

## Table PZ3 — General Characteristics for PolyZen Devices

Operating temperature range	-40° to +85°C
Storage temperature	-40° to +85°C
ESD withstand	15kV Human body model
Diode capacitance	4200pF Typical @ 1MHz, 1V RMS
Construction	RoHS compliant

## Figures PZ22-PZ34 — Basic Operation Examples for PolyZen Devices - LS Series

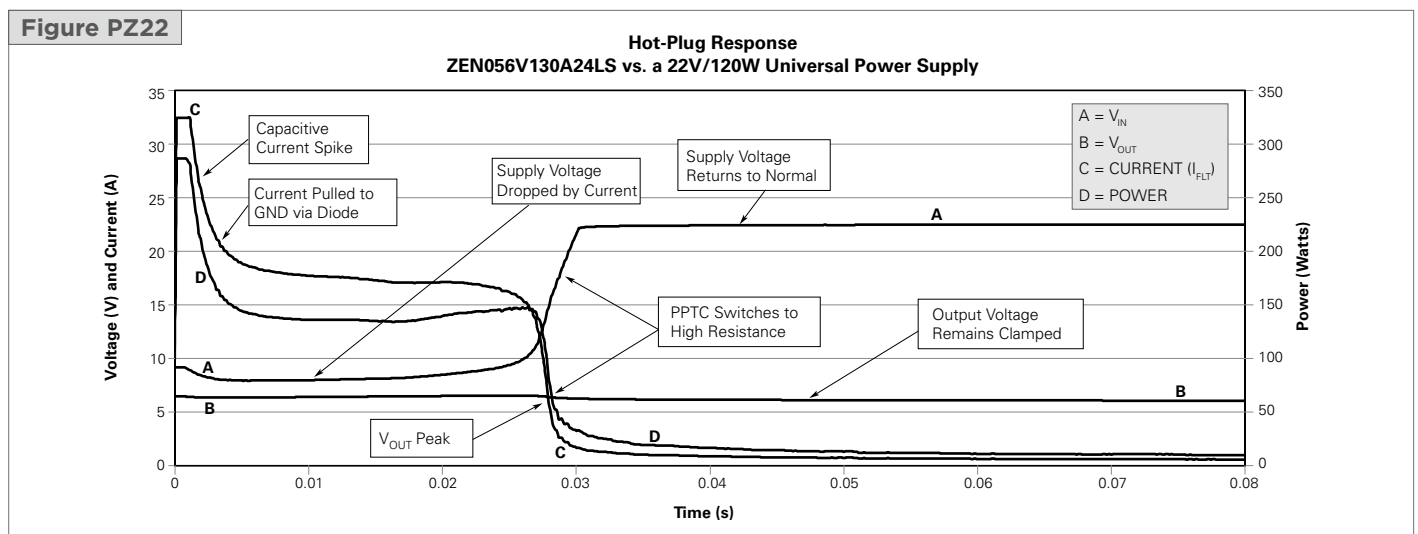

Figures PZ22-PZ34 – Basic Operation Examples for PolyZen Devices - LS Series (Cont'd)

**Figure PZ23** Typical Fault Response: ZEN056V1xxA24LS  
20V, 3.5A Current Limited Source ( $I_{OUT}=0$ )

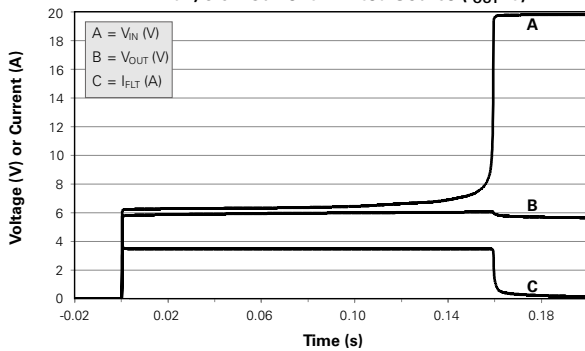

**Figure PZ24** Typical Fault Response: ZEN059V130A24LS  
24V, 6A Current Limited Source ( $I_{OUT}=0$ )

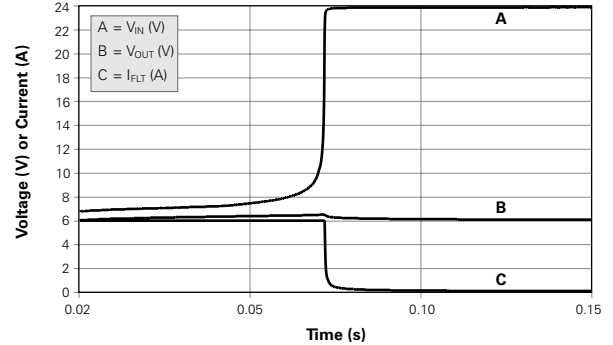

**Figure PZ25** Typical Fault Response: ZEN065V130A24LS  
24V, 5.0A Current Limited Source ( $I_{OUT}=0$ )

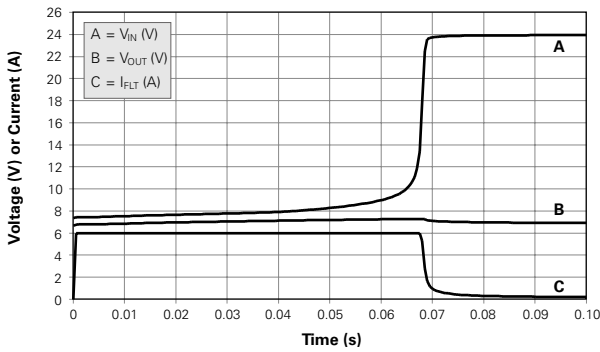

**Figure PZ26** Typical Fault Response: ZEN098V130A24LS  
24V, 3.5A Current Limited Source ( $I_{OUT}=0$ )

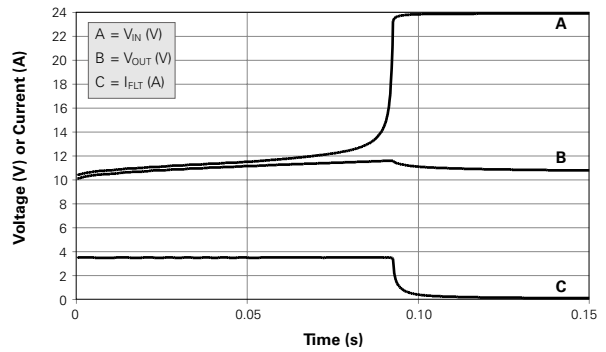

**Figure PZ27** Typical Fault Response: ZEN132V130A24LS  
24V, 2.0A Current Limited Source ( $I_{OUT}=0$ )

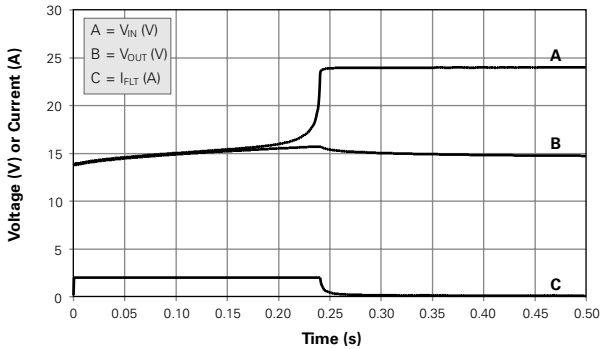

**Figure PZ28** Typical Fault Response: ZEN164V130A24LS  
24V, 1.0A Current Limited Source ( $I_{OUT}=0$ )

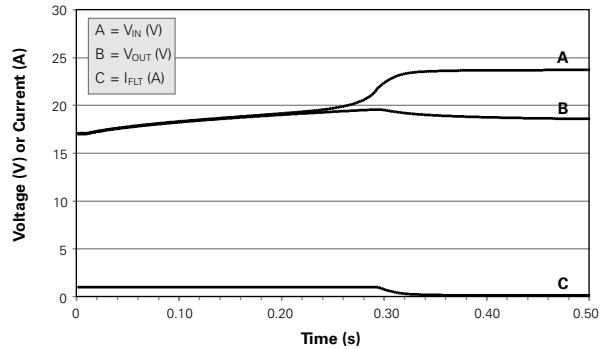

**Figure PZ29** Typical Fault Response: ZEN056V230A16LS  
16V, 5.0A Current Limited Source ( $I_{OUT}=0$ )

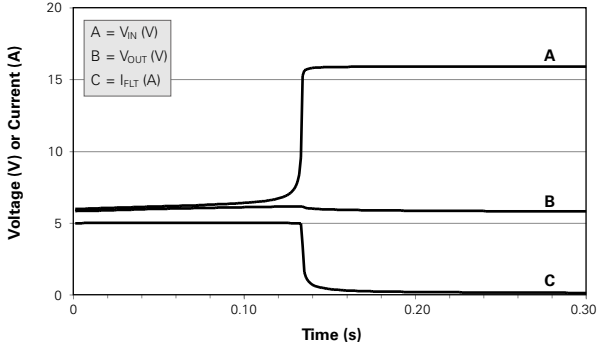

**Figure PZ30** Typical Fault Response: ZEN065V230A16LS  
16V, 3.5A Current Limited Source ( $I_{OUT}=0$ )

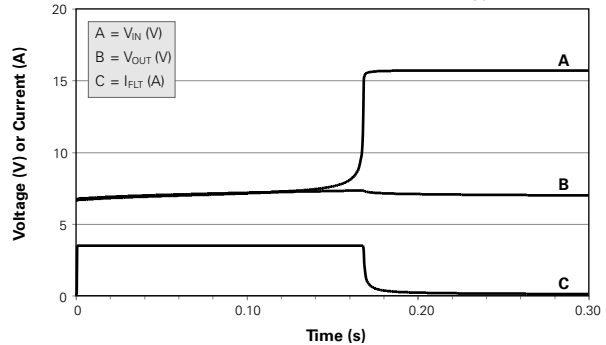

## Figures PZ22-PZ34 – Basic Operation Examples for PolyZen Devices - LS Series (Cont'd)

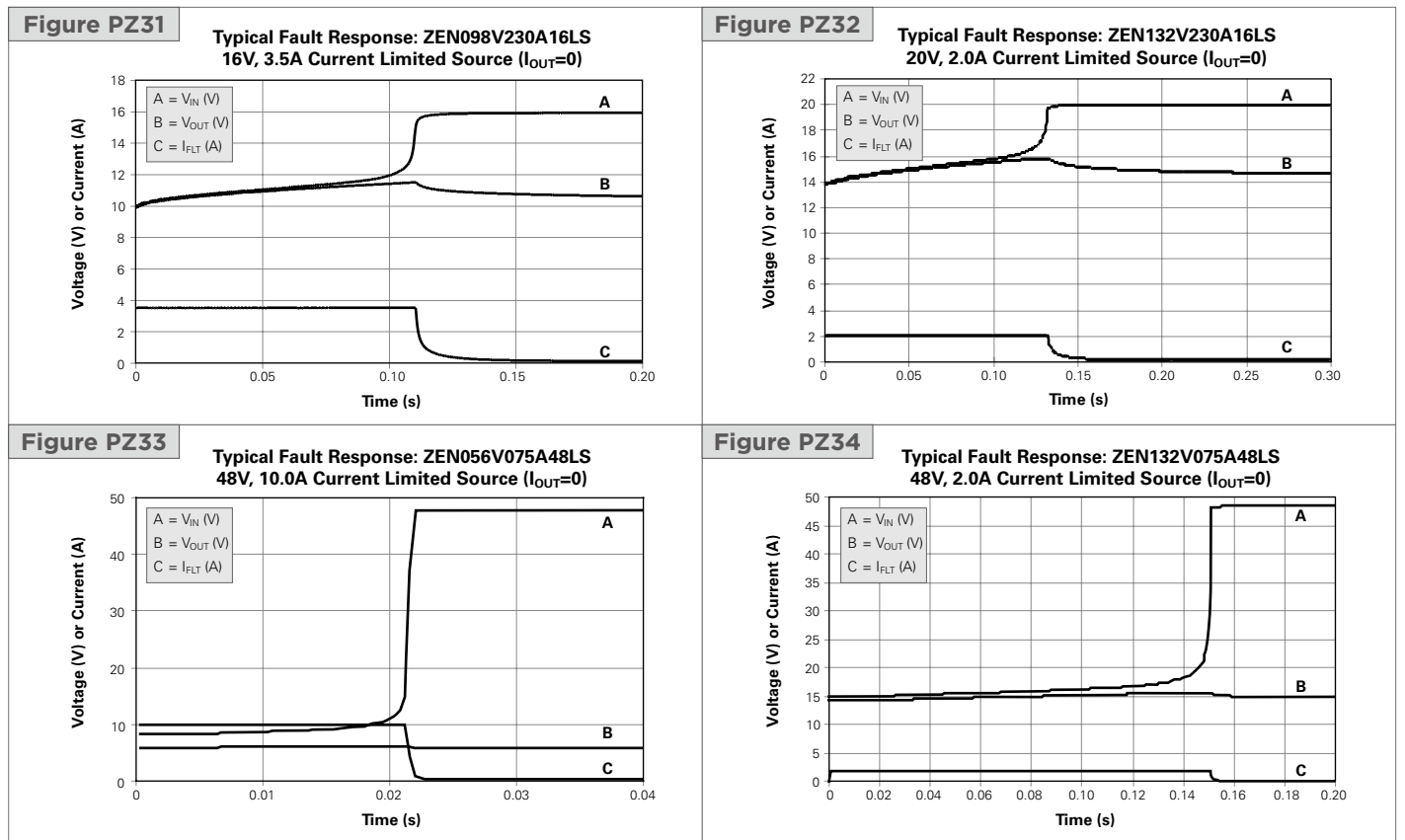

## Figures PZ35-PZ38 – Basic Operation Examples for PolyZen Devices - YM Series

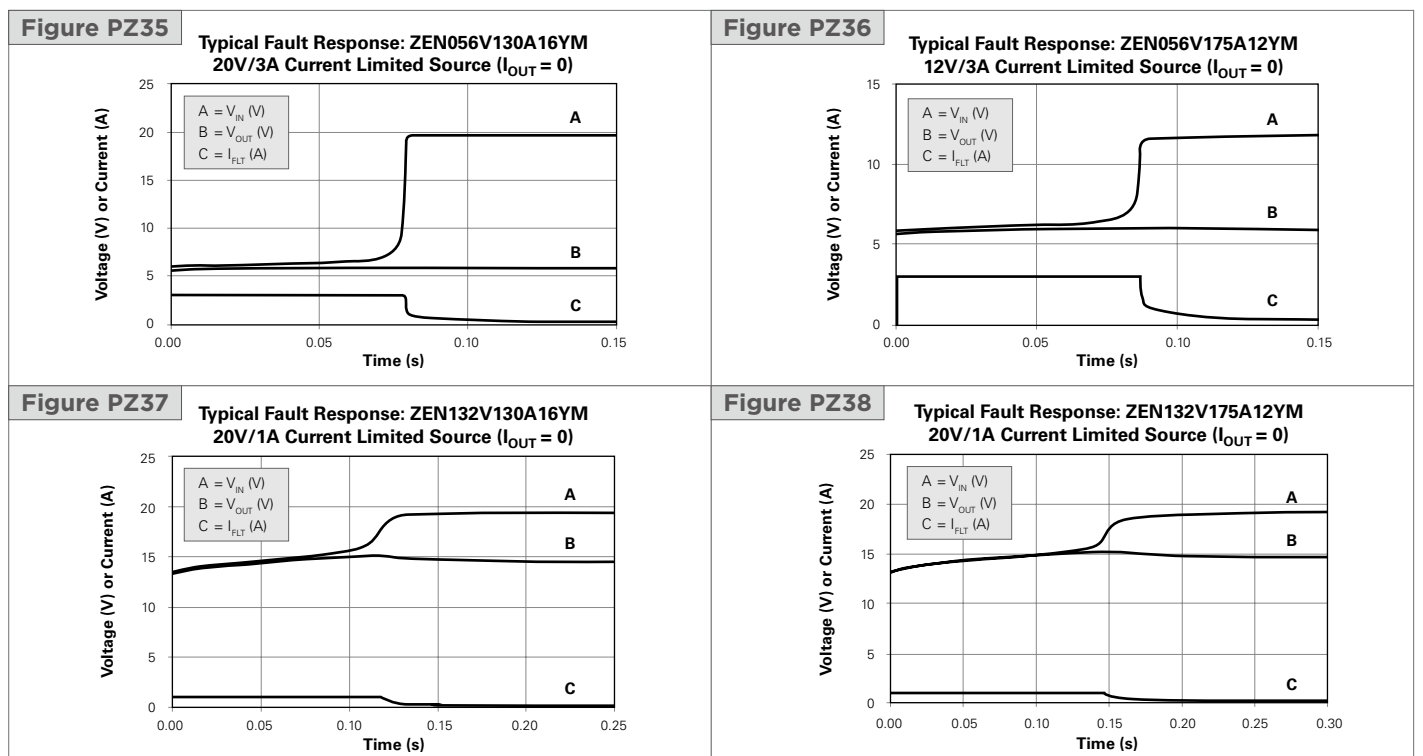

## Figures PZ39-PZ44 – Basic Operation Examples for PolyZen Devices - YC Series

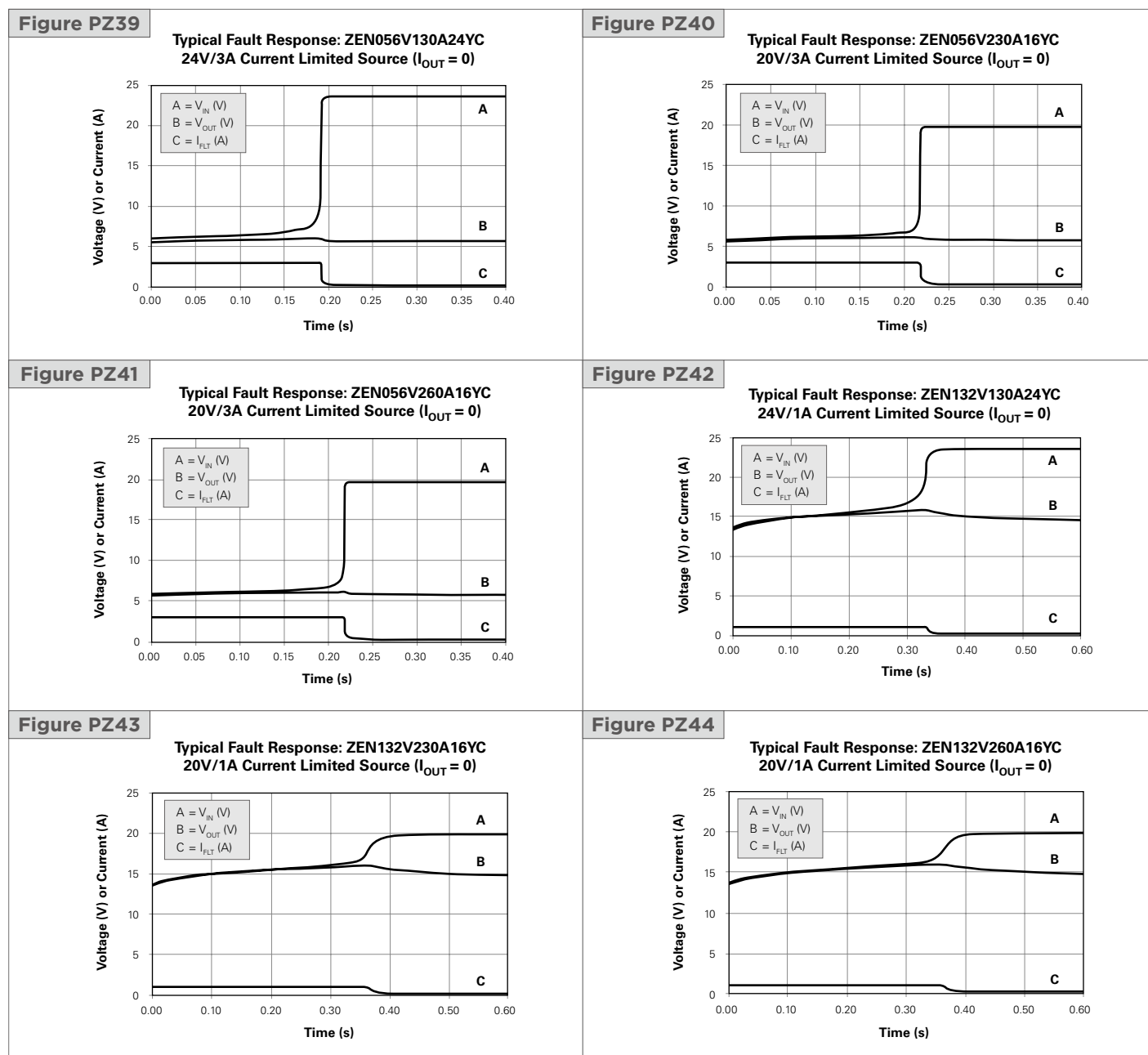

## Table PZ4 - Packaging and Marking Information for PolyZen Devices

Part Number	Bag Quantity	Tape & Reel Quantity	Standard Package
ZENxxxVyyyAzzLS	—	3,000	15,000
ZENxxxVyyyAzzYM	—	3,000	30,000
ZENxxxVyyyAzzYC	—	4,000	20,000



# 4 PolyZen Devices Polymer Protected Zener Diode

Table PZ5 – Dimensions in Millimeters and (Inches)

### ZENxxxVyyyAzzLS Devices

	A		B		C	
	Min	Max	Min	Max	Min	Max
mm	3.85	4.15	3.85	4.15	1.40	2.00
in	(0.152)	(0.163)	(0.152)	(0.163)	(0.055)	(0.081)

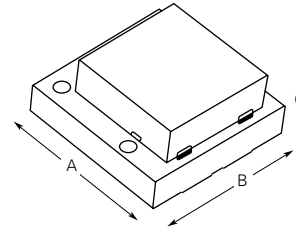

### ZENxxxVyyyAzzYM Devices

	A		B		C	
	Min	Max	Min	Max	Min	Max
mm	3.00	3.40	2.30	2.70	1.10	1.30
in	(0.118)	(0.134)	(0.091)	(0.106)	(0.043)	(0.051)

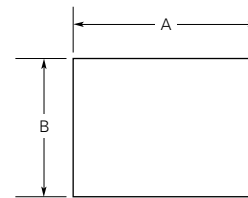
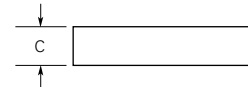

### ZENxxxVyyyAzzYC Devices

	A		B		C	
	Min	Max	Min	Max	Min	Max
mm	4.80	5.20	3.80	4.20	1.20	1.40
in	(0.190)	(0.206)	(0.150)	(0.166)	(0.047)	(0.055)

Table PZ6 – Pad Layout and Configuration Information

### ZENxxxVyyyAzzLS Devices

Pin Number	Pin Name	Pin Function
1	$V_{IN}$	$V_{IN}$ = Protected input to Zener diode
2	GND	GND = Ground
3	$V_{OUT}$	$V_{OUT}$ = Zener regulated voltage output

Pin Configuration (Top View)

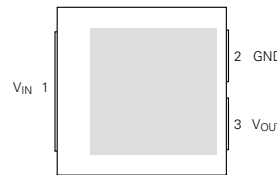

Pad Dimensions

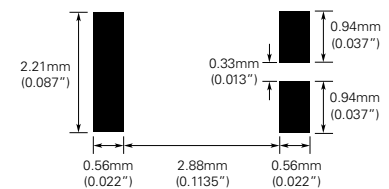

### ZENxxxVyyyAzzYM Devices

Pin Number	Pin Name	Pin Function
1	$V_{IN}$	$V_{IN}$ = Protected input to Zener diode
2	GND	GND = Ground
3	$V_{OUT}$	$V_{OUT}$ = Zener regulated voltage output

Pin Configuration (Top View)

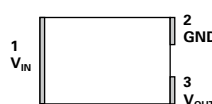

Recommended Pad Dimensions (mm)

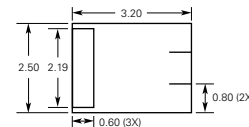

Recommended Pad Layout (mm)

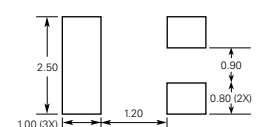

### ZENxxxVyyyAzzYC Devices

Pin Number	Pin Name	Pin Function
1	$V_{IN}$	$V_{IN}$ = Protected input to Zener diode
2	GND	GND = Ground
3	$V_{OUT}$	$V_{OUT}$ = Zener regulated voltage output

Pin Configuration (Top View)

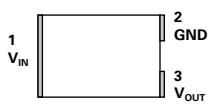

Recommended Pad Dimensions (mm)

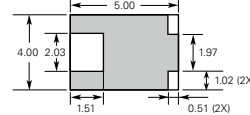

Recommended Pad Layout (mm)

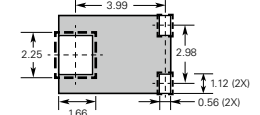

## Solder Reflow and Rework Recommendation

### Classification Reflow Profiles

Profile Feature	ZENxxxVyyyAzzLS Devices	ZENxxxVyyyAzzYM Devices	ZENxxxVyyyAzzYC Devices
	Pb-Free Assembly		Pb-Free Assembly
<b>Average Ramp Up Rate (Ts<sub>MAX</sub> to Tp)</b>	3°C/ s Max		3°C/ s Max
<b>Preheat</b>			
• Temperature Min (Ts <sub>MIN</sub> )	150°C		150°C
• Temperature Max (Ts <sub>MAX</sub> )	200°C		200°C
• Time (ts Preheat)	60-180 s		60-180 s
<b>Time Maintained Above:</b>			
• Temperature (T <sub>L</sub> )	217°C		217°C
• Time (t <sub>L</sub> )	60-150 s		60-150 s
<b>Peak/Classification Temperature (Tp)</b>	260°C		250°C
<b>Time within 5°C of Actual Peak Temperature</b>			
Time (tp)	20-40 s		20-40 s
<b>Average Ramp Down Rate (Tp to T<sub>L</sub>)</b>	6°C/ s Max		3°C/ s Max
<b>Time 25°C to Peak Temperature</b>	8 Minutes Max		8 Minutes Max

**Note:** All temperatures refer to top side of the package, measured on the package body surface.

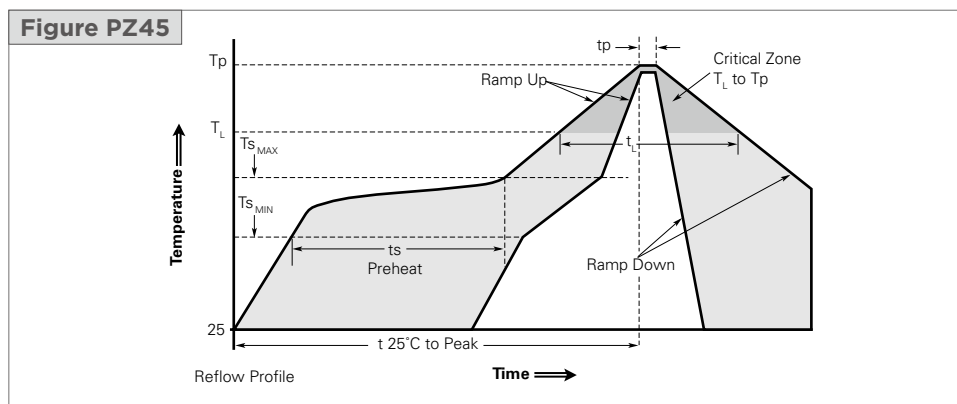

## Tape and Reel Specifications for PolyZen Devices in Millimeters

Figure PZ46 – EIA Referenced Taped Component Dimensions for ZENxxxVyyyAzzLS Devices in Millimeters (mm)

Description	ZENxxxVyyyAzzLS Devices
A <sub>0</sub>	4.35
B <sub>0</sub>	4.35
K <sub>0</sub>	2.30

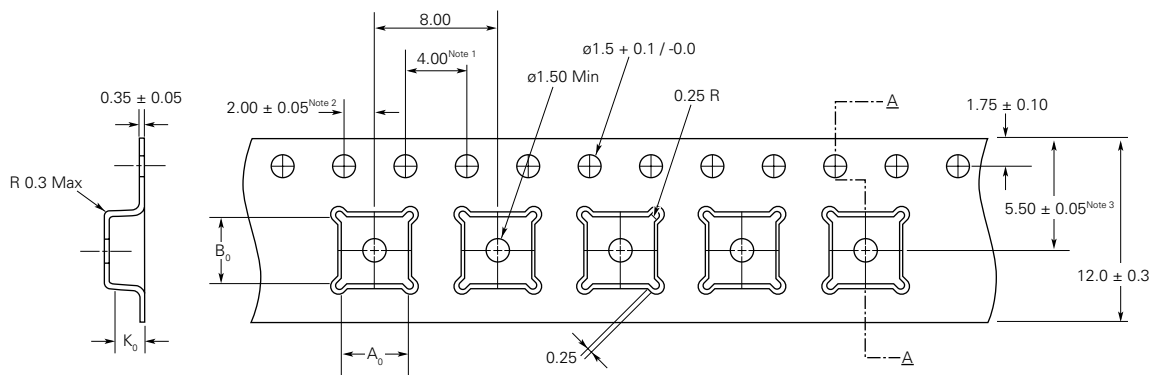

- Notes:**
- 10 sprocket hole pitch cumulative tolerance  $\pm 0.2$
  - Camber in compliance with EIA 481
  - Pocket position relative to sprocket hole measured as true position of pocket, not pocket hole

# 4 PolyZen Devices Polymer Protected Zener Diode

Figure PZ47 – Reel Dimensions for ZENxxxVyyyAzzLS Devices in Millimeters (mm)

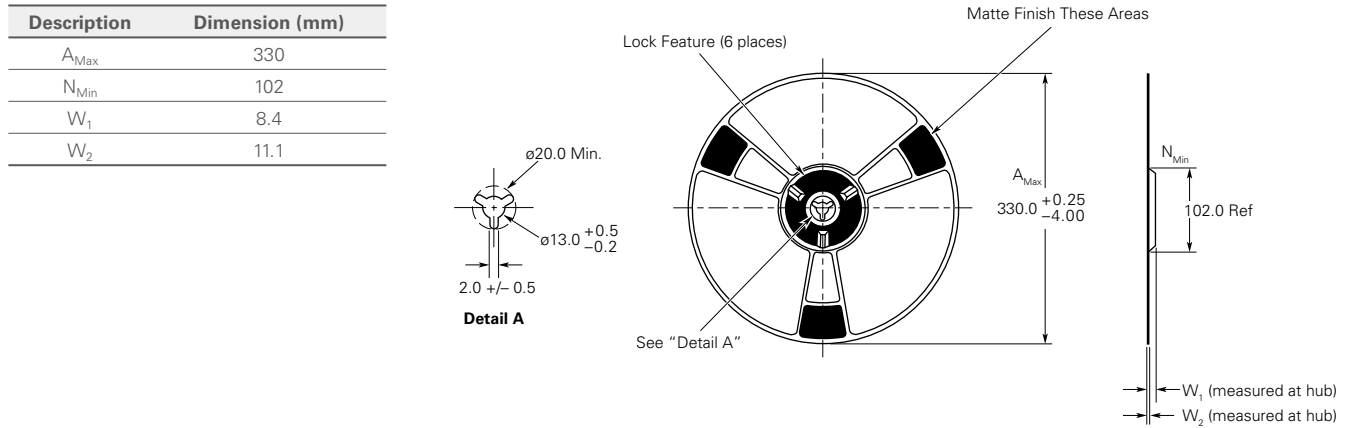

Figure PZ48 – EIA Referenced Taped Component Dimensions for ZENxxxVyyyAzzYM Devices in Millimeters (mm)

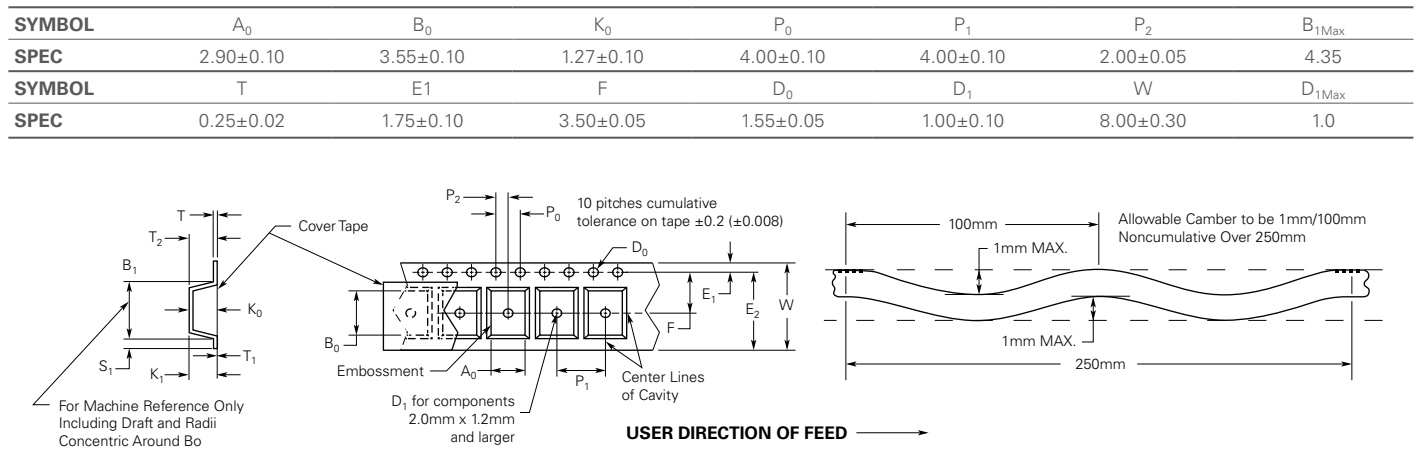
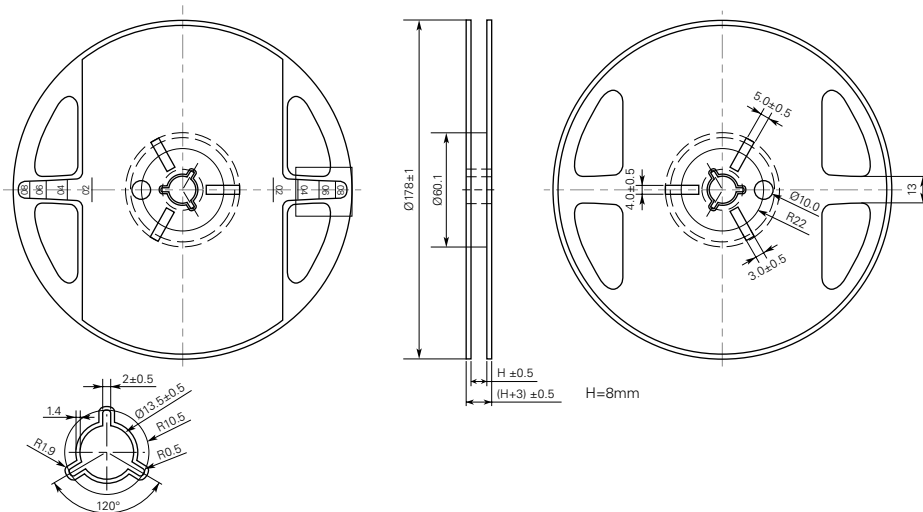

Figure PZ49 – Reel Dimensions for ZENxxxVyyyAzzYM Devices in Millimeters (mm)



## 4 PolyZen Devices Polymer Protected Zener Diode

Figure PZ50 – EIA Referenced Taped Component Dimensions for ZENxxxVyyyAzzYC Devices in Millimeters (mm)

Item	Dimension	Tolerance
W	12.00	±0.10
P	8.00	±0.10
E	1.75	±0.10
F	5.50	±0.10
P <sub>2</sub>	2.00	±0.10
D	1.50	+0.10 -0.00
D <sub>1</sub>	1.50	±0.10
P <sub>0</sub>	4.00	±0.10
10P <sub>0</sub>	40.00	±0.20
A <sub>0</sub>	4.20	±0.10
B <sub>0</sub>	5.25	±0.10
K <sub>0</sub>	1.40	±0.10
t	0.24	±0.05

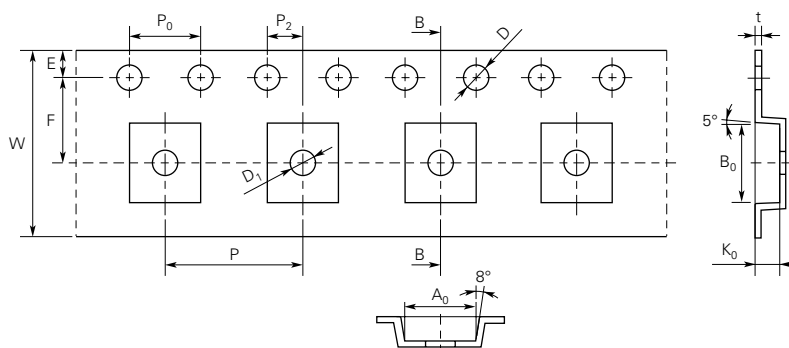
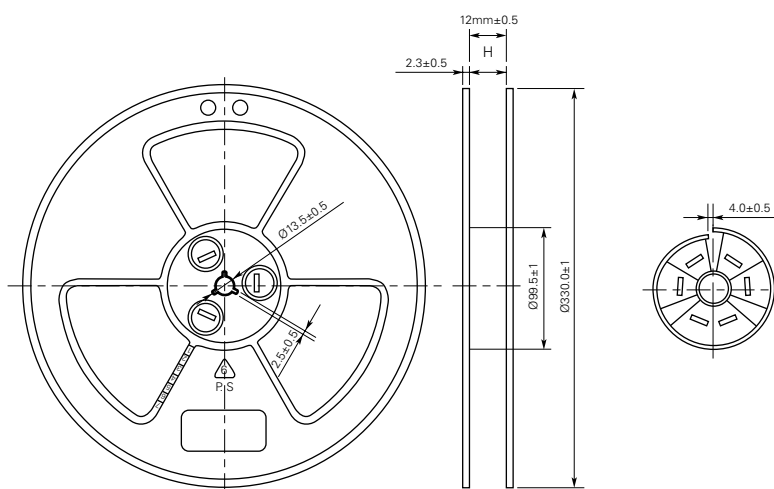
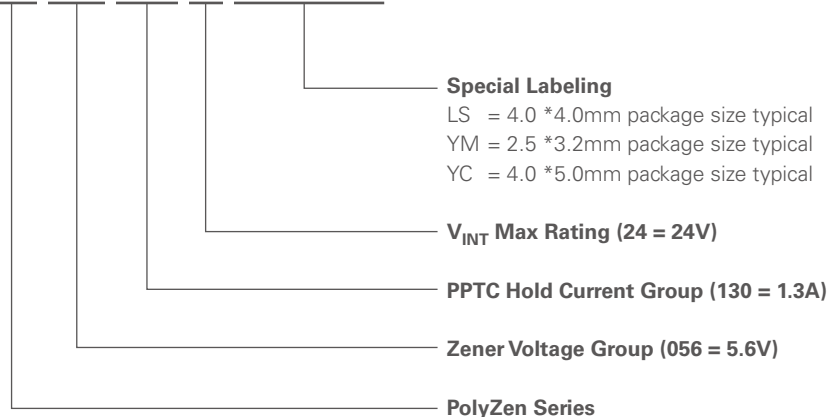

Figure PZ51 – Reel Dimensions for ZENxxxVyyyAzzYC Devices in Millimeters (mm)



### Part Numbering System

ZEN 056V 130A 24 LS & YC & YM



# 4

## PolyZen Devices Polymer Protected Zener Diode

### Part Marking System

#### ZENxxxVyyyAzzLS Devices

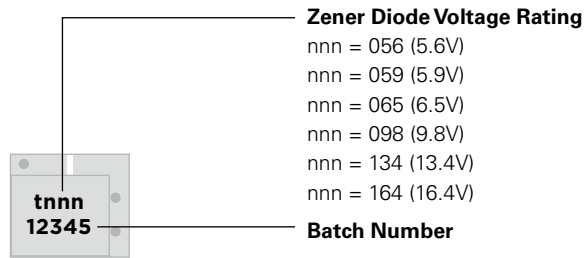

#### ZENxxxVyyyAzzYM Devices

Markings	V <sub>z</sub>	Hold Current	Special Code	Part Description
0513F	5.6V	1.3A	F	ZEN056V130A16YM
0517F	5.6V	1.75A	F	ZEN056V175A12YM
1313F	13.2V	1.3A	F	ZEN132V130A16YM
1317F	13.2V	1.75A	F	ZEN132V175A12YM

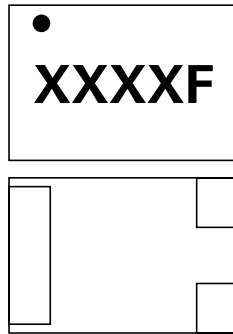

#### ZENxxxVyyyAzzYC Devices

Markings	V <sub>z</sub>	Hold Current	Special Code	Part Description
0513F	5.6V	1.3A	F	ZEN056V130A24YC
052XF	5.6V	2.3A	F	ZEN056V230A16YC
052XF	5.6V	2.6A	F	ZEN056V230A16YC
1313F	13.2V	1.3A	F	ZEN132V130A24YC
132XF	13.2V	2.3A	F	ZEN132V230A16YC
132XF	13.2V	2.6A	F	ZEN132V230A16YC
####				Last 4 digits of batch number

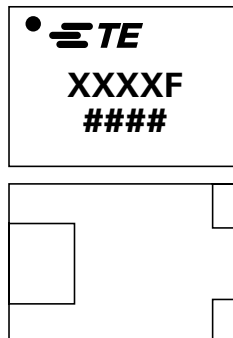

**Notice:**

Information furnished is believed to be accurate and reliable. However, users should independently evaluate the suitability of and test each product selected for their own applications. Tyco Electronics Corporation and its affiliates in the TE Connectivity Ltd. group of companies ("TE") reserve the right to change or update, without notice, any information contained in this publication; to change, without notice, the design, construction, processing, or specification of any product; and to discontinue or limit production or distribution of any product. This publication supersedes and replaces all information previously supplied. Without express written consent by an officer of TE, TE does not authorize the use of any of its products as components in nuclear facility applications, aerospace, or in critical life support devices or systems. TE expressly disclaims all implied warranties regarding the information contained herein, including, but not limited to, any implied warranties of merchantability or fitness for a particular purpose. TE's only obligations are those in the TE Standard Terms and Conditions of Sale and in no case will TE be liable for any incidental, indirect, or consequential damages arising from the sale, resale, use, or misuse of its products.