

Item description

Distribution connector *WINSTA*® MIDI rated current 25 A

Use effective pluggable connections instead of laborious screw connections: With the *WINSTA*® MIDI distribution connector with protection against mismatching. On PCBs, in control cabinets or for connecting lights – pluggable installation connectors from WAGO allow you to make connections according to an enormous variety of requirements in seconds. For greater protection in electrical installations, the pluggable installation connector is equipped with mechanical protection against mismatching. The pluggable installation connector offers touch-proof protection with live components in accordance with protection type IP20 (When mated: IP2xC (These compact connectors are not designed for use in open, easily accessible areas!)). Solutions like the *WINSTA*® MIDI pluggable installation connectors with B coding are appropriate for applications related to process control, such as for lighting or in data networks. This pluggable installation connector can be employed for a voltage load of up to 25 A. Therefore, it can also be used for high power loads. The *WINSTA*® MIDI Pluggable Connection System with Push-in CAGE CLAMP® spring pressure connection technology facilitates precise electrification. Due to the included test slot, it is possible to check connections even when they are plugged in. That

Subject to changes. Please also observe the further product documentation!



saves time and reduces installation labor and expense.

WINSTA® MIDI solutions for your electrical installation – protected against mismatching and maintenance-free

WINSTA® is the pluggable connection system that is optimally tailored to the strict requirements of electrical installation. It offers fast, secure and, above all, error-free installation of components and cables. Choose quality and durability – the WINSTA® MIDI pluggable installation connector with locking lever from WAGO makes the installation of electrical components substantially easier.

- pluggable installation connectors with protection against mismatching
- for automation controllers
- with B coding for controllers such as lighting fixtures and sun blinds
- exact dimensions
- rapid, structured electrical installation

Data Notes

Variants: Other pole markings
Other versions (or variants) can be requested from WAGO Sales or configured at <https://configurator.wago.com/>.

Electrical data

Ratings per IEC/EN

Ratings per	IEC/EN 60664-1
Nominal voltage (III/3)	250 V
Rated impulse voltage (III/3)	4 kV
Rated current	25 A
Legend (ratings)	(III / 3) ≙ Overvoltage category III / Pollution degree 3

Ratings per UL 1977

Note for the US market	Some versions may also be used for current interruption in accordance with the UL certificate in select applications with currents below 16 A and voltages up to 600 V. For further information, please contact your local sales office.
Rated voltage (UL 1977)	600 V
Rated current UL 1977	23 A

Subject to changes. Please also observe the further product documentation!

WAGO GmbH & Co. KG
Hansastr. 27
32423 Minden
Phone: +49571 887-0 | Fax: +49571 887-169
Email: info.de@wago.com | Web: www.wago.com

Do you have any questions about our products?
We are always happy to take your call at +49 (571) 887-44222.



General

Note on contact resistance	approx. 1 mΩ of contact resistance approx. 0.25 mΩ contact transition plug/socket
----------------------------	--

Connection data

Total number of potentials	2
----------------------------	---

Connection 1

Pole number	2
-------------	---

Physical data

Pin spacing	10 mm / 0.394 inches
Width	20 mm / 0.787 inches
Height	32.7 mm / 1.287 inches
Depth	45.8 mm / 1.803 inches

Mechanical Data

Application	Control technology
Coding	B
Variable coding	No
Marking	1 2
Potential marking	1 2
Mating force of a plug-in connection	approx. 20 ... 70 N (depending on pole number)
Retention force of a plug-in connection	When locked: > 80 N
Unmating force of a plug-in connection	Unlocked: approx. 20 ... 70 N (depending on pole number)
Number of mating cycles	200, without resistive load
Type of distribution box	Distribution connector, 3-way
Protection type	IP20; When mated: IP2xC (These compact connectors are not designed for use in open, easily accessible areas!)

Plug-in connection

Contact type (pluggable connector)	Socket/plug
Mismating protection	Yes
Note on mismating protection	All WINSTA [®] components are 100% protected against mismating when:

Subject to changes. Please also observe the further product documentation!



- a.) plugging different numbers of poles
- b.) plugging while rotated 180
- c.) plugging while laterally staggered
- d.) plugging one pole

Locking lever	yes
Locking of plug-in connection	locking lever
Note on locking system	All connectors for mounted installations (snap-in versions for lighting fixtures or devices, all types of PCB and distribution connectors) are factory-equipped with locking levers to ensure plugs and sockets are securely locked. Additional locking levers are only required for flying leads (plug/socket).
Number of locking levers	4

Material Data

Note (material data)

Information on material specifications can be found here

Color	gray
Insulation material	Polyamide (PA66)
Flammability class per UL94	V0
Contact material	Copper or copper alloy; surface-treated
Contact plating	Tin
Fire load	0.31 MJ
Weight	17.8 g

Environmental requirements

Processing temperature	-5 ... +40 °C
Continuous operating temperature	-35 ... +85 °C
Note on continuous operating temperature	Insulating parts for temperatures \leq 105 °C

Commercial data

eCl@ss 10.0	27-44-06-03
eCl@ss 9.0	27-44-06-03
ETIM 8.0	EC002567
ETIM 7.0	EC002567
PU (SPU)	50 pcs
Packaging type	box
Country of origin	DE
GTIN	4055143297806

Subject to changes. Please also observe the further product documentation!

WAGO GmbH & Co. KG
 Hansastr. 27
 32423 Minden
 Phone: +49571 887-0 | Fax: +49571 887-169
 Email: info.de@wago.com | Web: www.wago.com

Do you have any questions about our products?
 We are always happy to take your call at +49 (571) 887-44222.

Customs tariff number

85366990990

Environmental Product Compliance

RoHS Compliance Status





Compliant, No Exemption

Approvals / Certificates

General approvals

Logo	Approval	Additional Approval Text	Certificate name
	cURus Underwriters Laboratories Inc.	UL 1977	E45171



Counterpart

	Item no. 770-242 Socket; 2-pole; Cod. B; 4,00 mm ² ; gray	www.wago.com/770-242
	Item no. 770-252 Plug; 2-pole; Cod. B; 4,00 mm ² ; gray	www.wago.com/770-252
	Item no. 771-8992/005-103 pre-assembled interconnecting cable; Eca; Socket/plug; 2-pole; Cod. B; Control cable 2 x 1.0 mm ² ; 1 m; 1,00 mm ² ; gray	www.wago.com/771-8992/005-103
	Item no. 771-8992/105-103 pre-assembled connecting cable; Eca; Socket/open-ended; 2-pole; Cod. B; Control cable 2 x 1.0 mm ² ; 1 m; 1,00 mm ² ; gray	www.wago.com/771-8992/105-103
	Item no. 771-8992/205-103 pre-assembled connecting cable; Eca; Plug/open-ended; 2-pole; Cod. B; Control cable 2 x 1.0 mm ² ; 1 m; 1,00 mm ² ; gray	www.wago.com/771-8992/205-103

Optional accessories

Cover

Cover

	Item no.: 770-360 Lockout cap; for plugs; 5-pole; separable; yellow	www.wago.com/770-360
	Item no.: 770-201 Lockout cap; 12-pole, separable; for sockets; Plastic; black	www.wago.com/770-201

Subject to changes. Please also observe the further product documentation!

WAGO GmbH & Co. KG

Hansastr. 27

32423 Minden

Phone: +49571 887-0 | Fax: +49571 887-169

Email: info.de@wago.com | Web: www.wago.com

Do you have any questions about our products?

We are always happy to take your call at +49 (571) 887-44222.

Item no.: 770-221

Lockout cap; 12-pole, separable; for sockets; Plastic; white

www.wago.com/770-221

Mounting

Mounting accessories



Item no.: 770-1626

Mounting plate; 2-pole; for distribution connectors; Plastic; black

www.wago.com/770-1626



Item no.: 770-1627

Mounting plate; 2-pole; for distribution connectors; Plastic; white

www.wago.com/770-1627

Downloads

Documentation

Bid Text

770-1704 X81 - Datei	2019 Feb 19	xml 2.8 kB	Download
770-1704 doc - Datei	2017 Apr 13	doc 23.6 kB	Download

Environmental Product Compliance

Compliance Search

Environmental Product Compliance 770-1704 3-way distribution connector; 2-pole; Cod. B; 1 input; 3 outputs; gray	URL	Download
---	-----	----------

Installation Notes

Installation

Subject to changes. Please also observe the further product documentation!

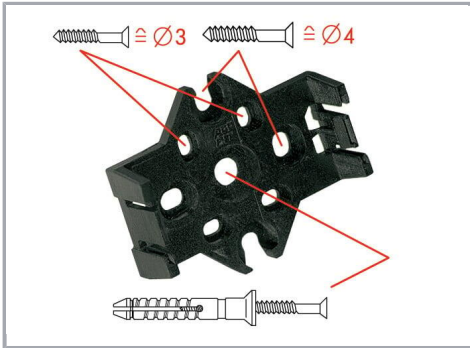

Mounting plates can be secured using commercially available screws or nail-drive anchors.



The distribution connectors snap together when attached to the mounting plate.



To release the distribution connector, unlock the latch using a screwdriver.

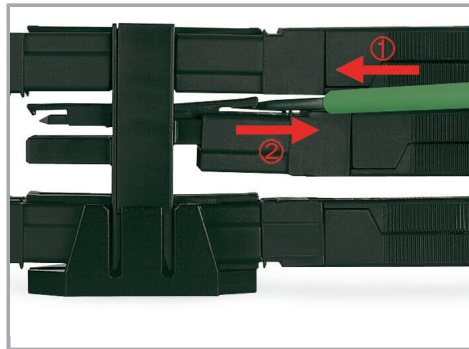

All distribution connector connections are locked and protected against accidental disconnection directly after mating. Locking of any connection is released using a screwdriver, even if all connections are used.

Product family

WINSTA® MIDI

[Show all products from the family](#)

Subject to changes. Please also observe the further product documentation!