

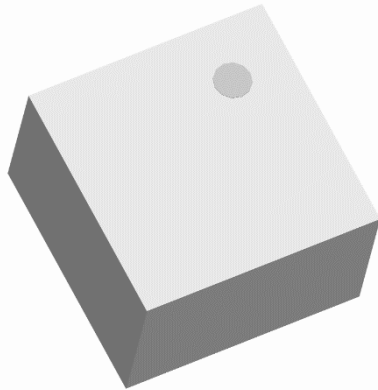

Ultra Low Profile 0404 Balun 50Ω to 50Ω Balanced



Description:

The BD1722N5050AHF is a low profile, low impedance sub-miniature unbalanced to balanced transformer targeted at the GSM, CDMA, WCDMA and UMTS designed for differential inputs and output locations on modern chipsets in an easy to use surface mount package. The BD1722N5050AHF is ideal for high volume manufacturing and delivers higher performance than traditional ceramic baluns. The BD1722N5050AHF has an unbalanced port impedance of 50Ω and a 50Ω balanced port impedance. The output ports have equal amplitude (-3dB) with 180 degree phase differential. The BD1722N5050AHF is available on tape and reel for pick and place high volume manufacturing.

Detailed Electrical Specifications:

Specifications subject to change without notice.

Features:	Parameter	ROOM (25°C)			ROOM (25°C)			Unit
		Min.	Typ.	Max	Min.	Typ.	Max	
• 1600 – 2200 MHz	Frequency	1600		2200	1700		2200	MHz
• 0.57 mm Height Profile	Unbalanced Port Impedance		50			50		Ω
• 50 Ohm to 2 x 25 Ohm	Balanced Port Impedance		50			50		Ω
• Class Leading CMRR	Return Loss	9.8	12.6		12.5	16.3		dB
• Targeted at GSM, CDMA, WCDMA and UMTS Applications	Insertion Loss*		0.95	1.30		0.82	1.02	dB
• Surface Mountable	Amplitude Balance		0.57	0.96		0.42	0.79	dB
• Tape & Reel	Phase Balance		3.42	6.82		3.42	6.82	Degrees
• Non-conductive Top Surface	CMRR		29			29		dB
• RoHS Compliant	Power Handling @85C			0.75			0.75	Watts
• Halogen Free	Power Handling @105C			0.45			0.45	°C
	Operating Temperature	-55		+105	-55		+105	

*Insertion Loss stated at room temperature (Insertion Loss is approximately 0.1 dB higher at +85 °C)

Outline Drawing:

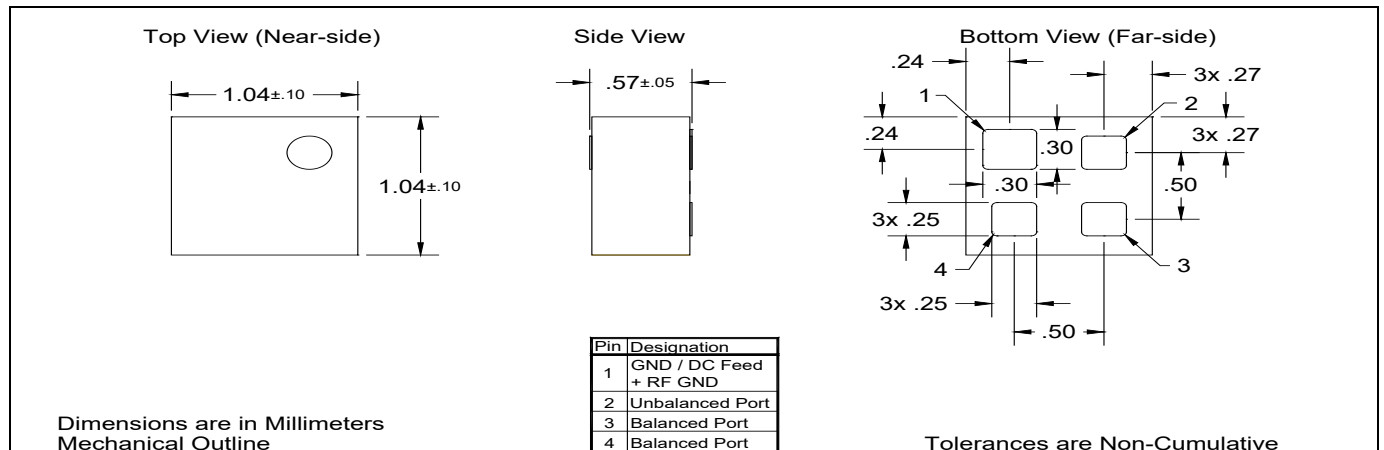

Typical Performance:

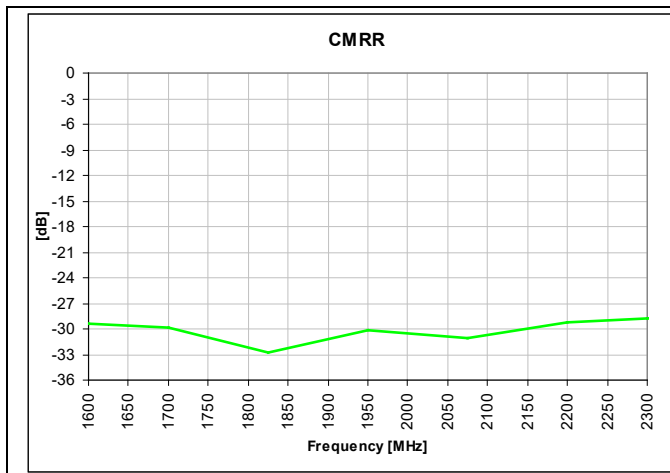
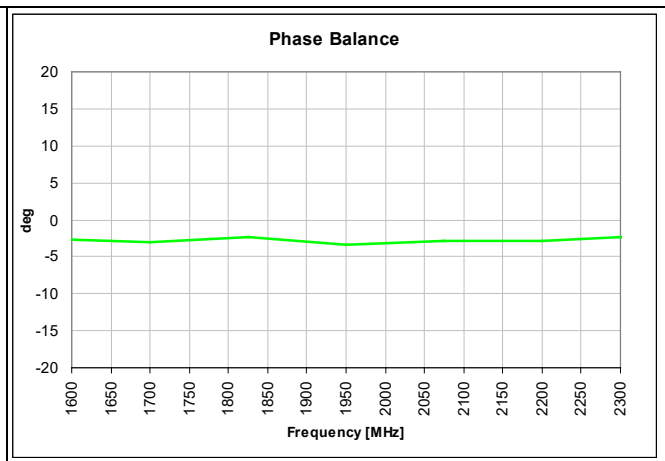
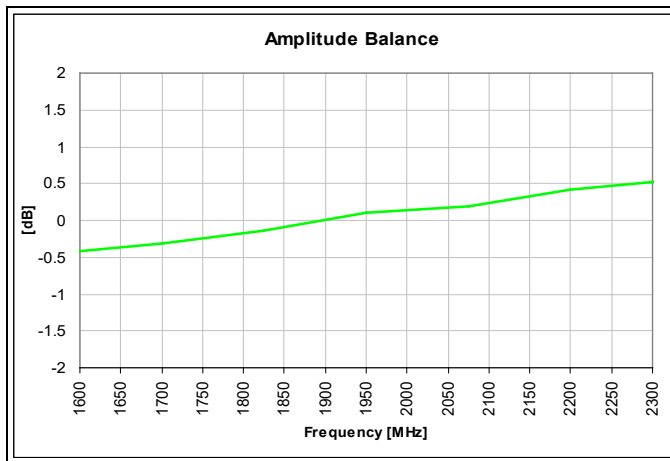
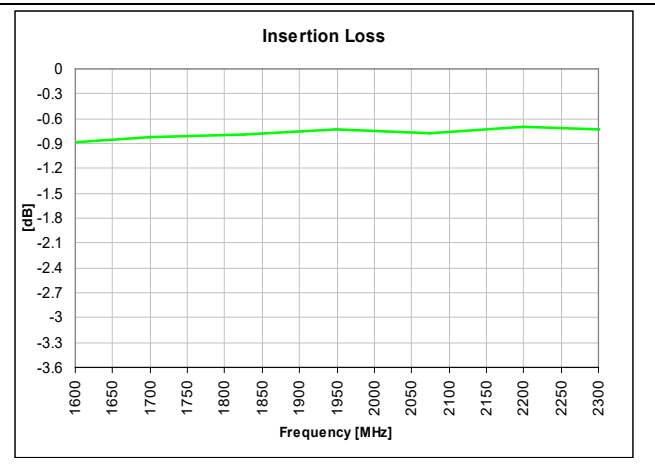
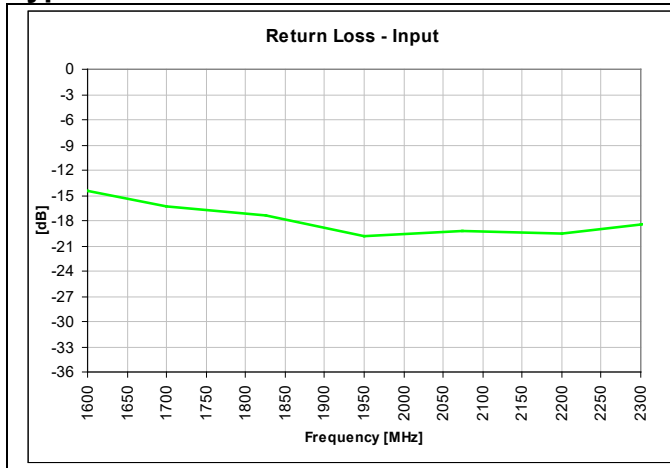

Wide Band Performance:

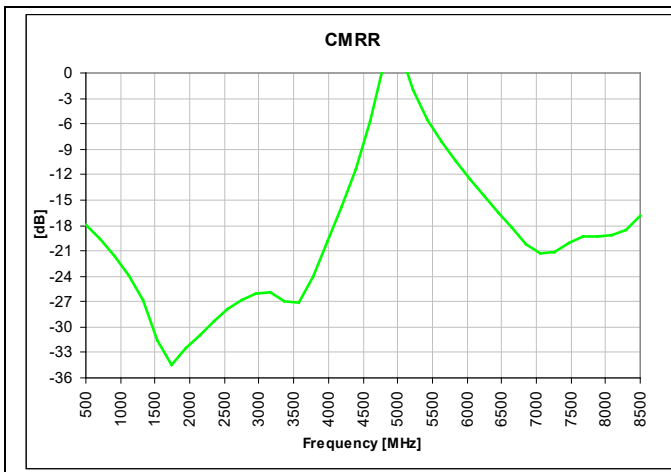
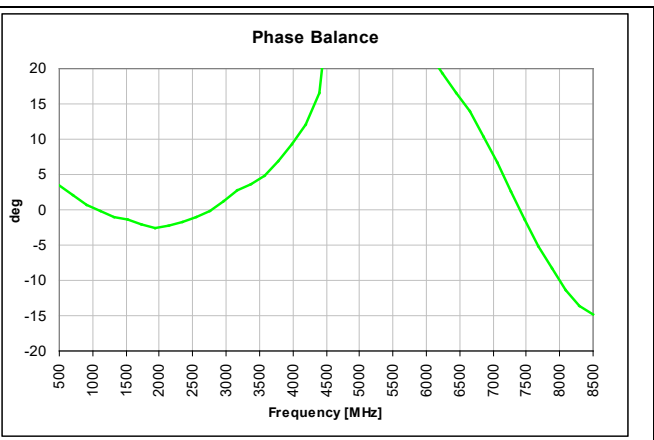
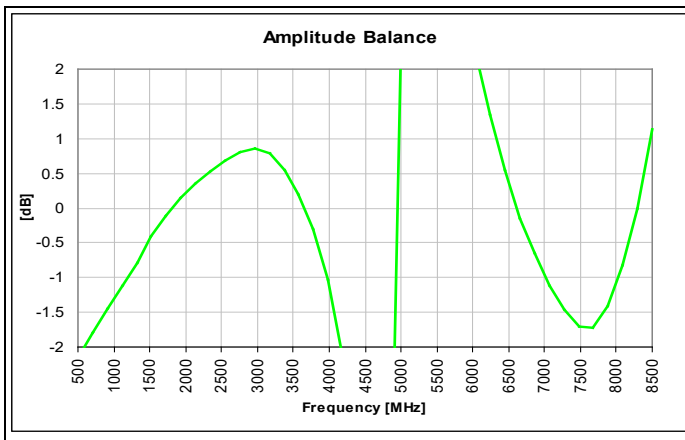
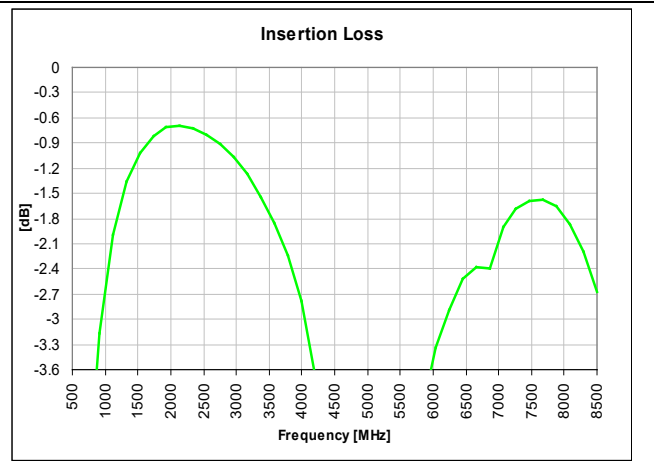
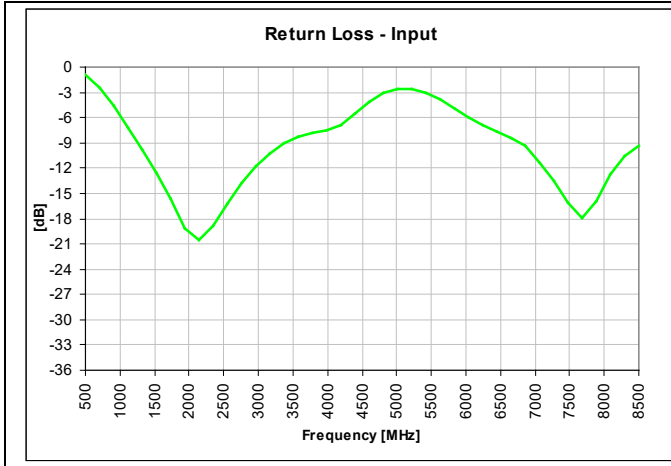

Mounting Configuration:

In order for Xinger surface mount components to work optimally, the proper impedance transmission lines must be used to connect to the RF ports. If this condition is not satisfied, insertion loss, Isolation and VSWR may not meet published specifications.

All of the Xinger components are constructed from organic PTFE based composites which possess excellent electrical and mechanical stability. Xinger components are compliant to a variety of ROHS and Green standards and ready for Pb-free soldering processes. Pads are Gold plated with Nickel barrier.

An example of the PCB footprint used in the testing of these parts is shown below. In specific designs, the transmission line widths need to be adjusted to the unique dielectric coefficient and thickness as well as varying pick and place equipment tolerances.

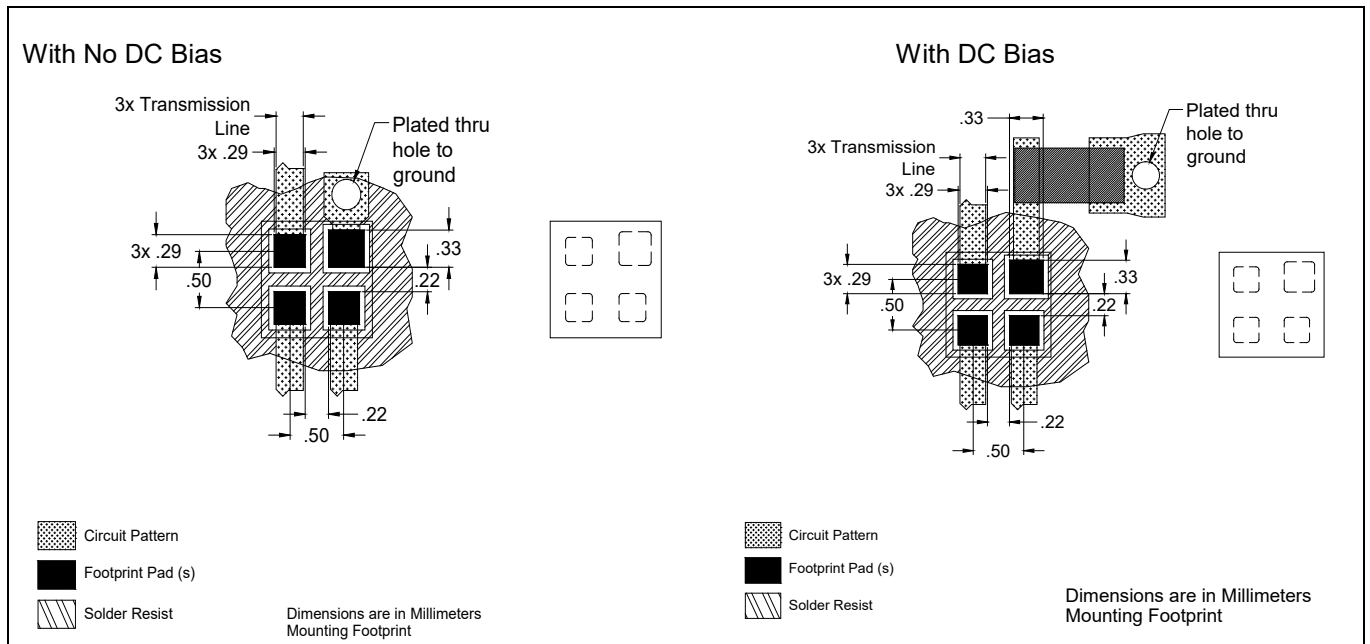

Packaging and Ordering Information:

Parts are available in reel and are packaged per EIA 481-D. Parts are oriented in tape and reel as shown below. Minimum order quantities are 4000 per reel.

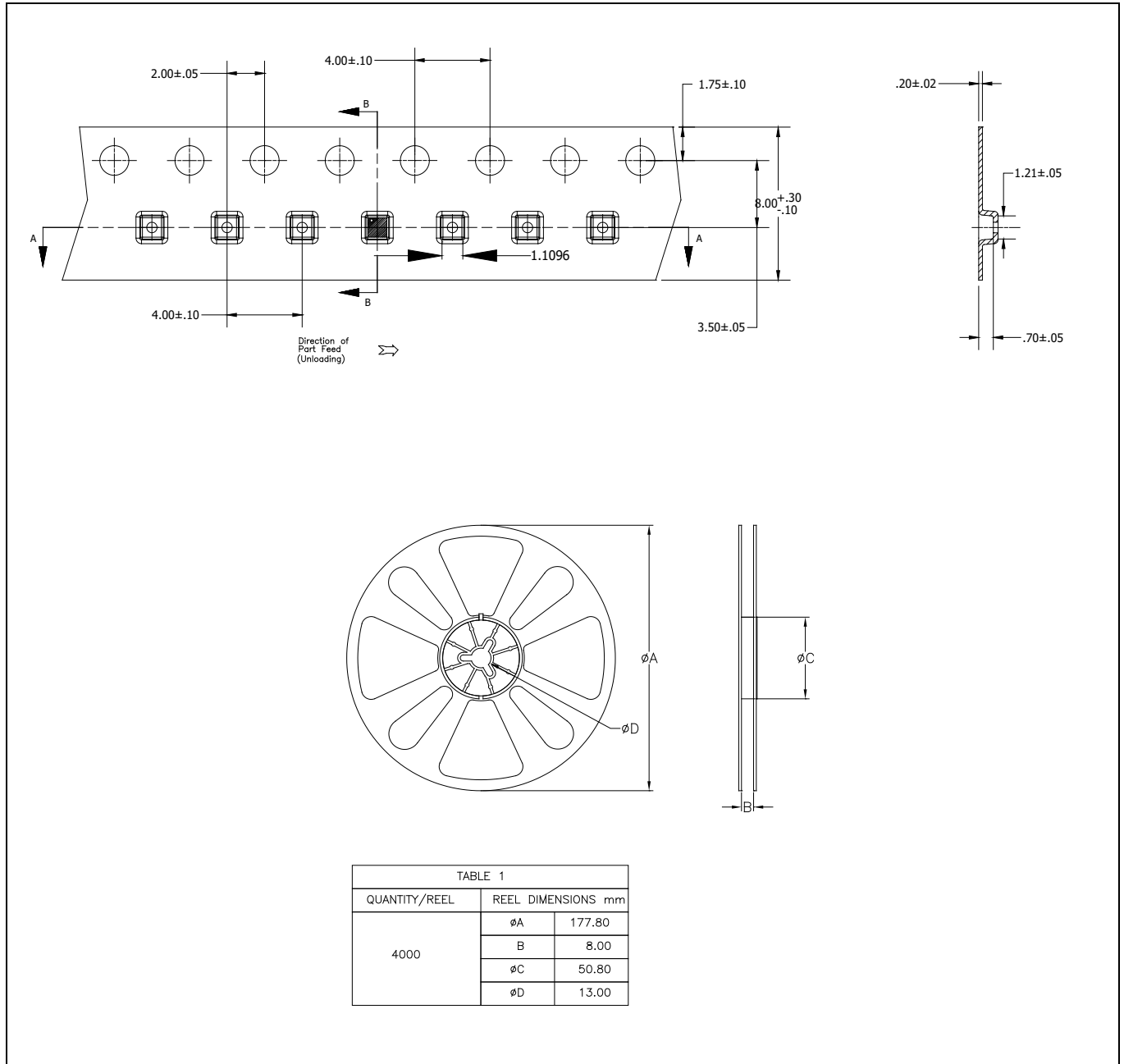

TABLE 1		
QUANTITY/REEL	REEL DIMENSIONS mm	
4000	φA	177.80
	B	8.00
	φC	50.80
	φD	13.00

Contact us:
rf&s_support@ttm.com