



TAOGLAS®



Datasheet

Triton – TD.10.5113

Description:

5dBi C-V2X 5.9GHz Dipole Terminal Antenna SMA(M) Hinged Connector

Features:

5.9GHz C-V2X Terminal Mount Dipole Antenna

5850MHz to 5925MHz

5dBi Gain

SMA(M) Hinged Connector

Dimensions: 169*18*13mm

RoHS & REACH Compliant

1. Introduction	3
2. Specifications	4
3. Antenna Characteristics	6
4. 2D Radiation Patterns	10
5. 3D Radiation Patterns	26
6. Mechanical Drawing	30
7. Packaging	31
<hr/>	
Changelog	32

Taoglas makes no warranties based on the accuracy or completeness of the contents of this document and reserves the right to make changes to specifications and product descriptions at any time without notice. Taoglas reserves all rights to this document and the information contained herein.

Reproduction, use or disclosure to third parties without express permission is strictly prohibited.



1. Introduction



The Triton TD.10 is a dipole terminal DSRC antenna. This high performance, compact 5 dBi antenna designed to operate between 5850-5925MHz for C-V2X systems. The TD.10 does not require a ground-plane to connect to and has market-leading efficiency of 70%. Connection is made via the hinged SMA(M) connector which can be oriented straight, 45 degrees, or at a right angle to best fit your needs.

C-V2X is the communications medium of choice for active safety V2V/V2X (Vehicle-to-Vehicle and Vehicle-to-Other) systems. Primarily allocated for vehicle safety applications, C-V2X supports high-speed, low-latency, short-range, V2V/V2X wireless communications.

For further optimization to customer-specific device environments and for support to integrate and test this antennas performance in your device, contact your regional Taoglas Customer Services Team.

2. Specifications

Electrical	
In Free Space	
Frequency	5850~5925MHz
Efficiency (%)	
Straight Pose	73.48
Bent Pose	64.58
Average Gain (dBi)	
Straight Pose	-1.34
Bent Pose	-1.9
Peak Gain (dBi)	
Straight Pose	5.88
Bent Pose	5.67
With 15*9cm Ground Plane	
Frequency	5850~5925MHz
Efficiency (%)	
Straight Pose	49.00
Bent Pose	46.77
Average Gain (dBi)	
Straight Pose	-3.10
Bent Pose	-3.30
Peak Gain (dBi)	
Straight Pose	3.07
Bent Pose	4.01
On 30*30cm Ground Plane Edge	
Frequency	5850~5925MHz
Efficiency (%)	
Straight Pose	58.49
Bent Pose	55.84
Average Gain (dBi)	
Straight Pose	-2.33
Bent Pose	-2.53
Peak Gain (dBi)	
Straight Pose	3.64
Bent Pose	5.39
On 30*30cm Ground Plane Center	
Frequency	5850~5925MHz
Efficiency (%)	
Straight Pose	65.24
Bent Pose	62.49
Average Gain (dBi)	
Straight Pose	-1.86
Bent Pose	-2.04
Peak Gain (dBi)	
Straight Pose	5.19
Bent Pose	10.41
Operation Band	DSRC 5.9GHz
Return Loss	< -10dB
VSWR	< 2:1
Polarization	Linear
Impedance	50 Ω

Mechanical	
Dimensions	Length 169mm, Φ 18mm
Casing	PC+ABS
Connector	Hinged SMA Male
Weight	21.75 g
Recommended Torque for Mounting	0.9 N·m
Max Torque for Mounting	1.176 N·m

Environmental	
Temperature Range	-40°C to 85°C
Humidity	Non-condensing 65°C 95% RH

3. Antenna Characteristics

3.1 Return Loss

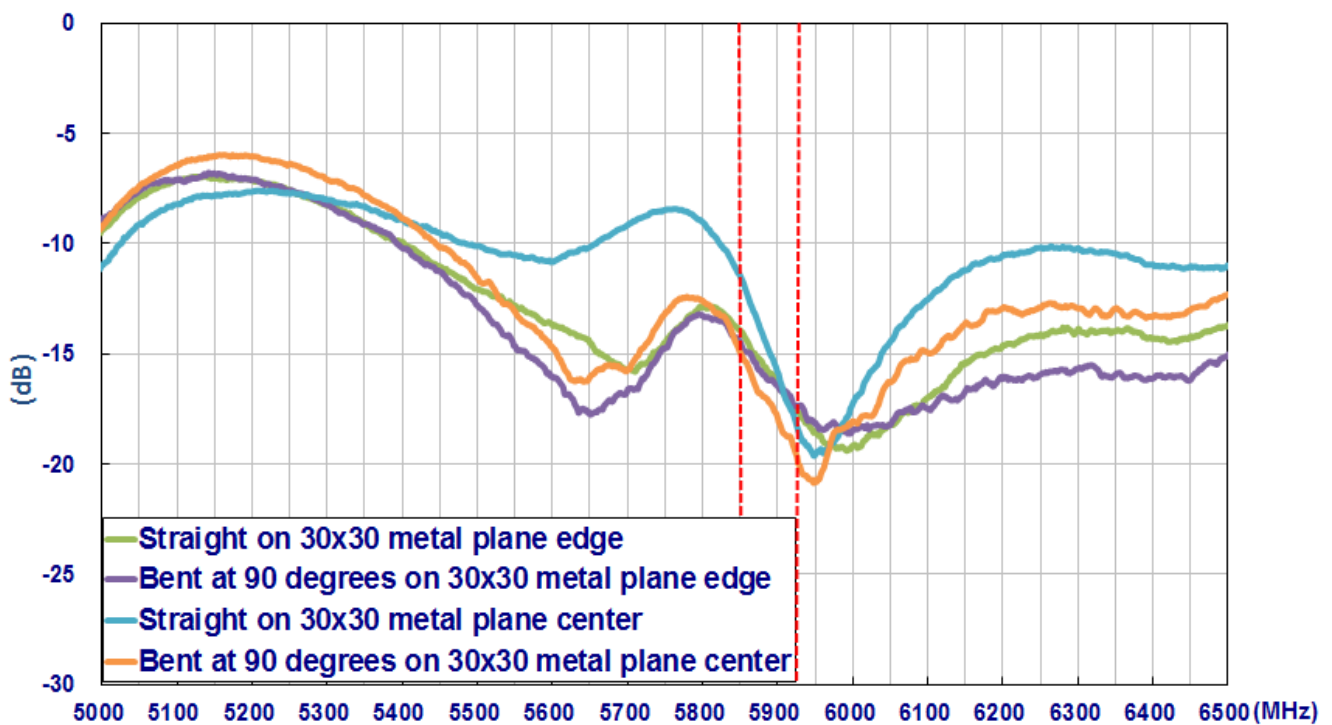
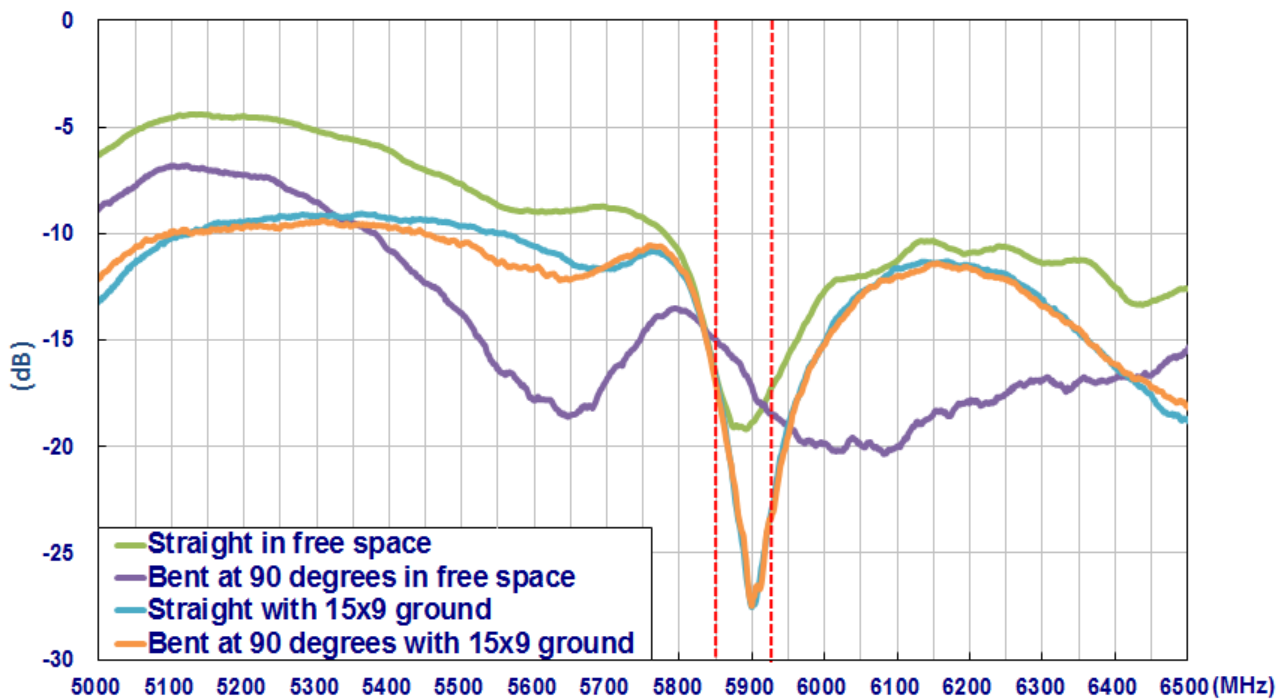

3.2 Peak Gain

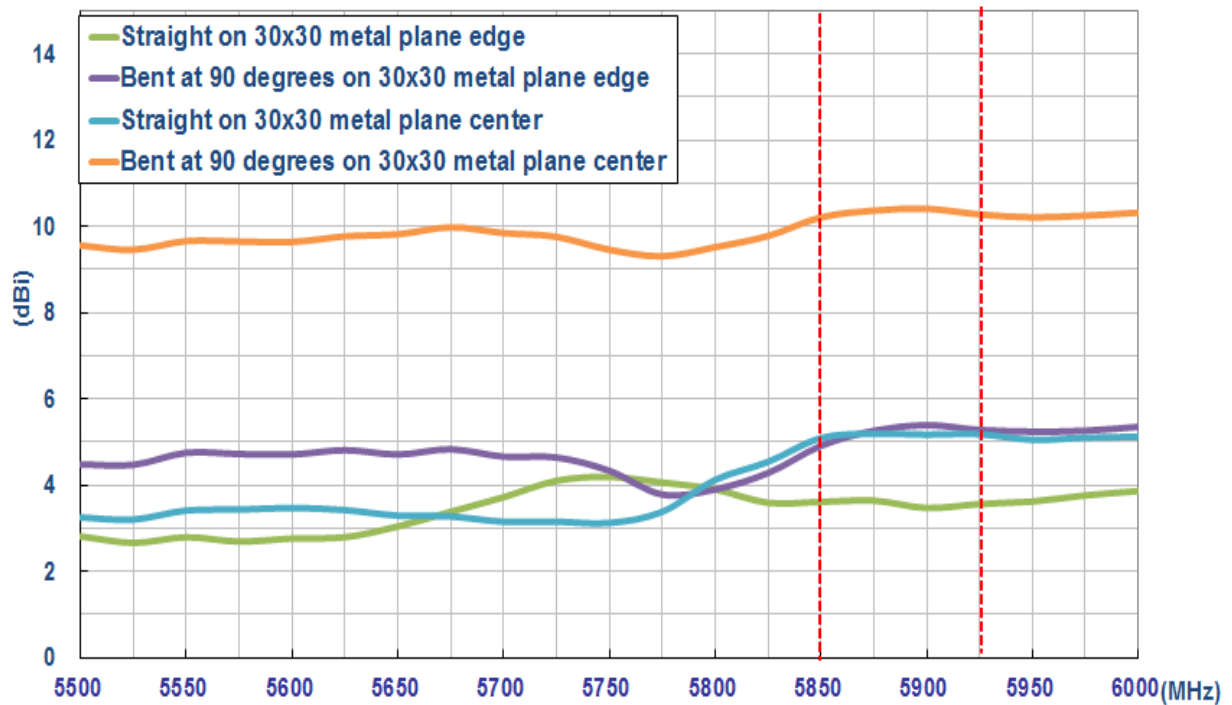
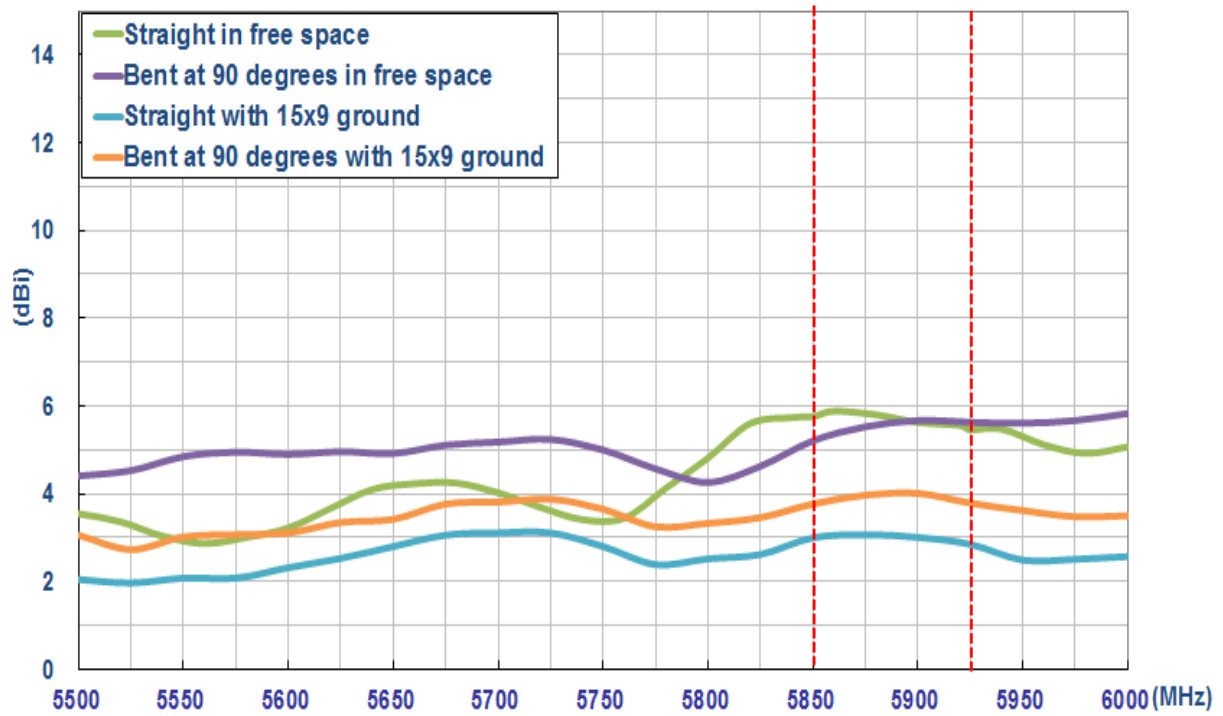

3.3 Efficiency

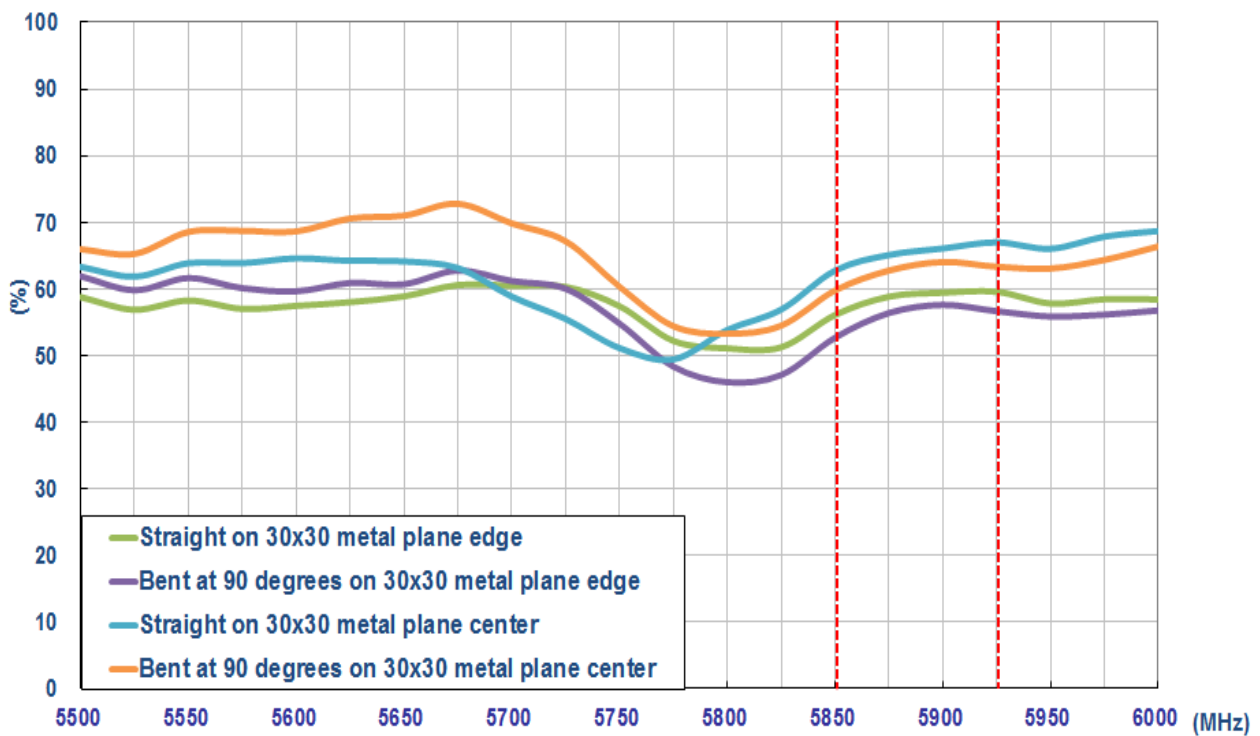
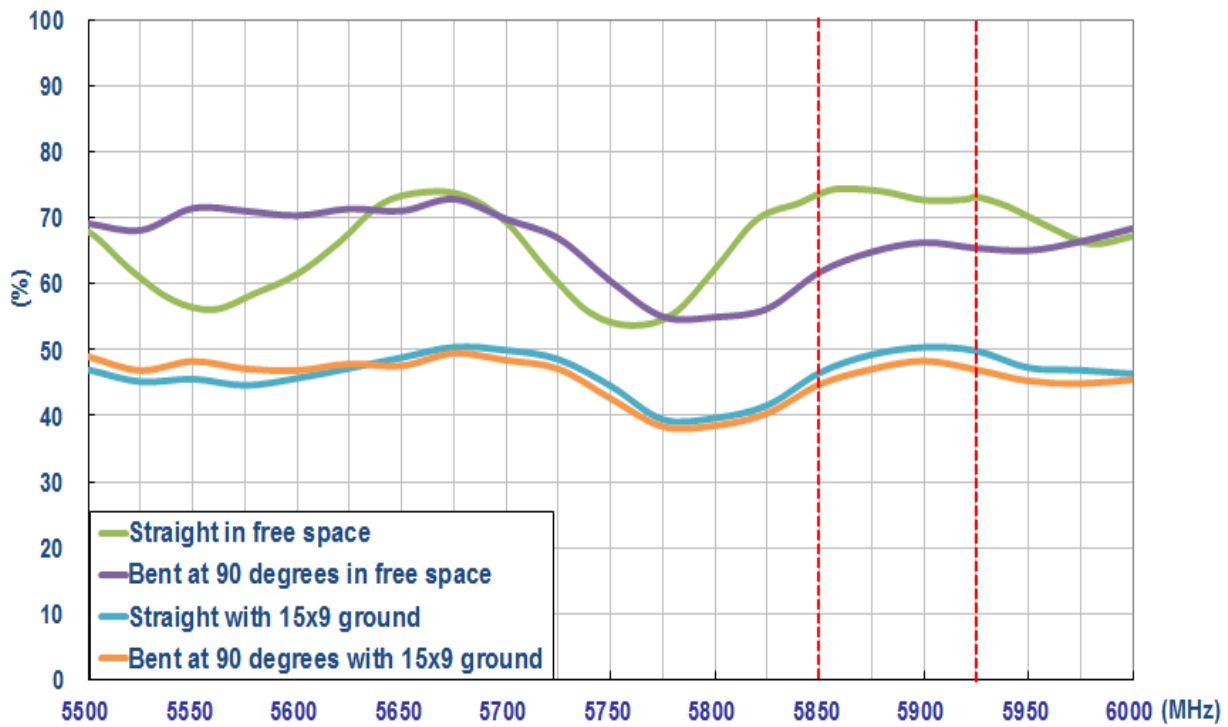

3.4 Average Gain

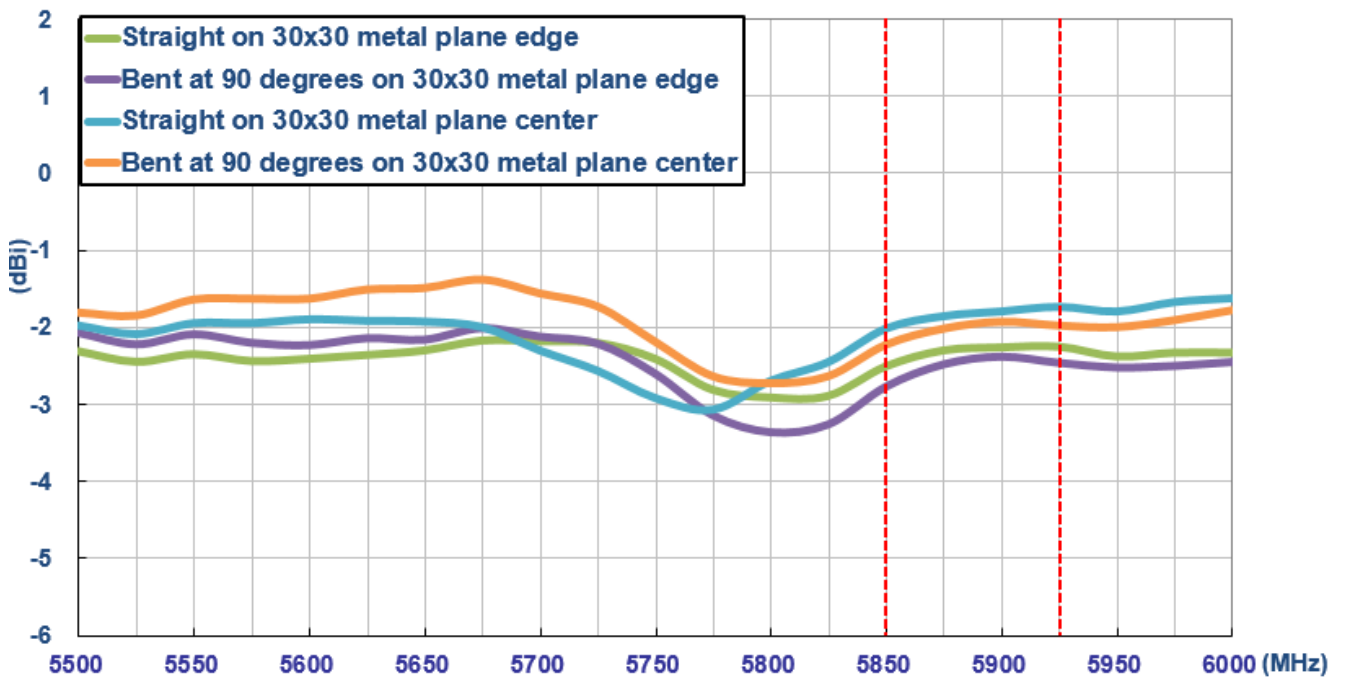
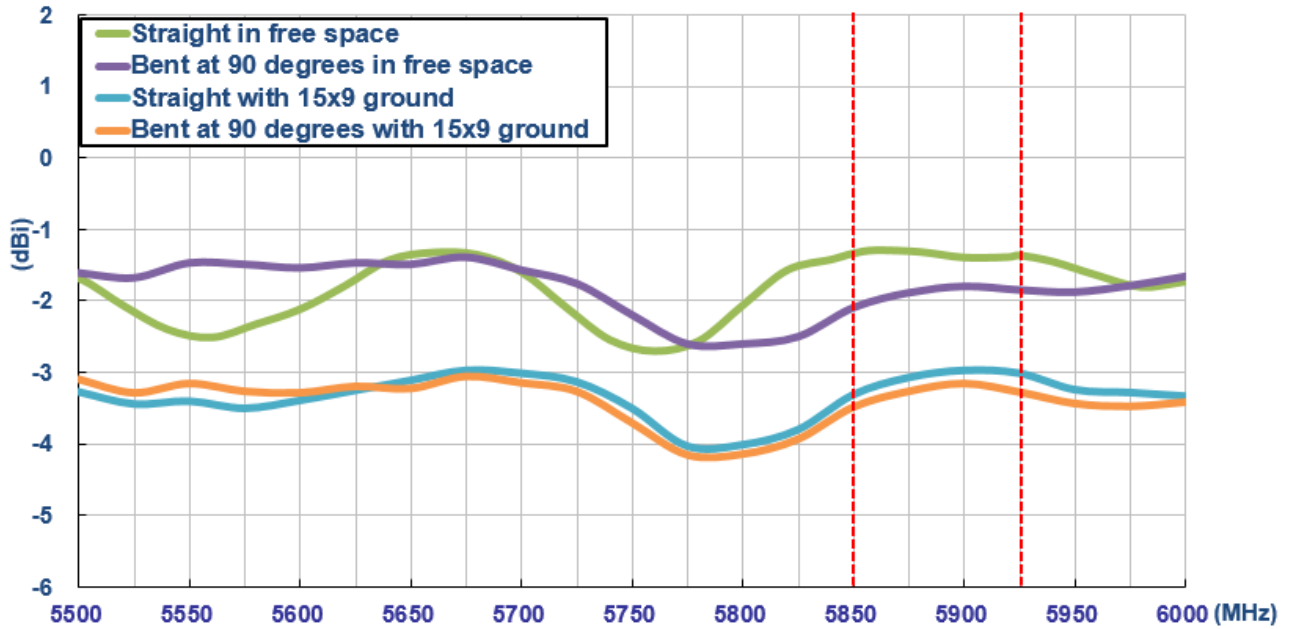

4. 2D Radiation Patterns

4.1 Test Setup

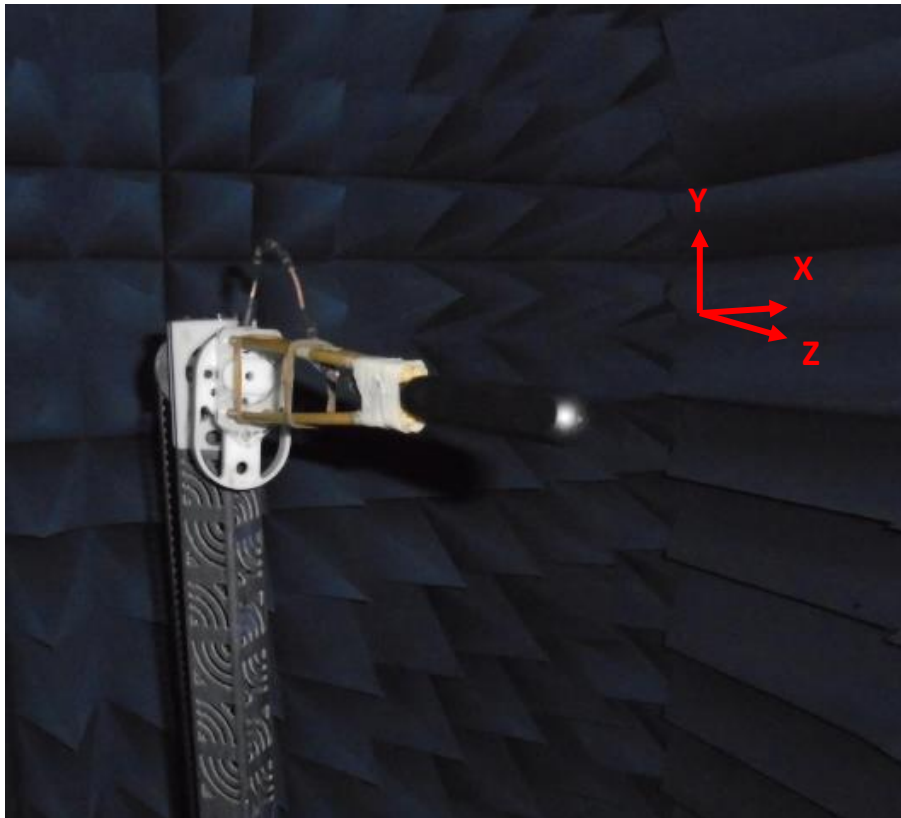

Free space Straight

XY Plane

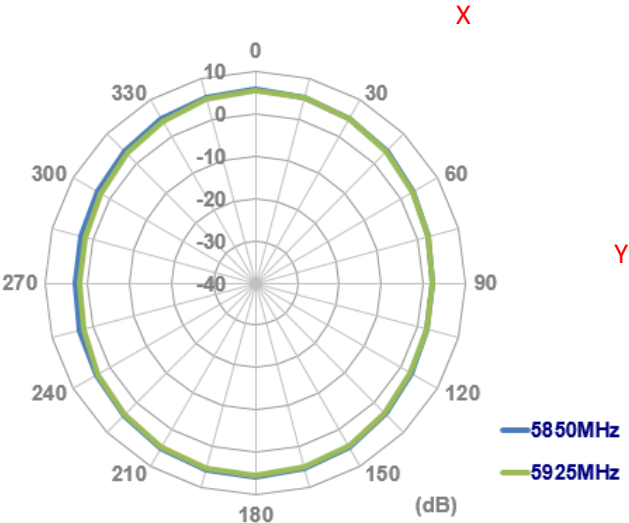

XZ Plane YZ Plane

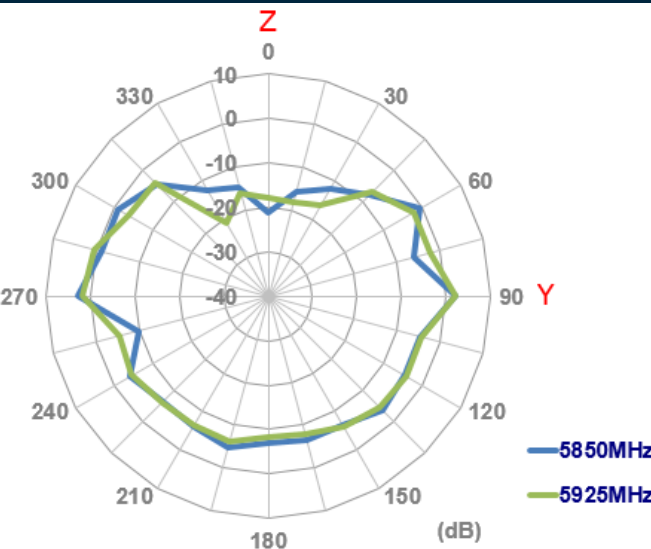
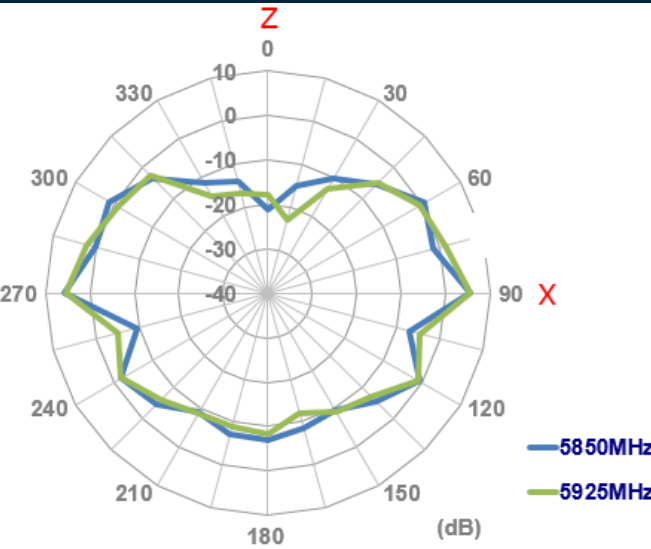

4.2 Test Setup

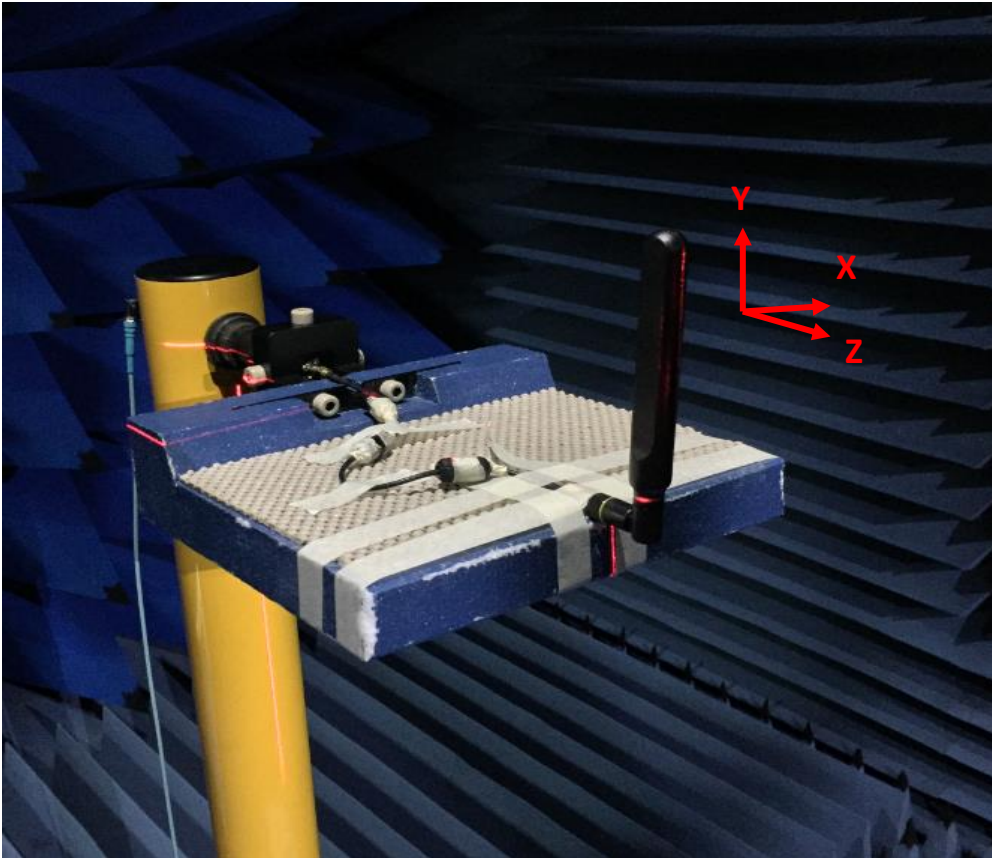

Free space bend

XY Plane

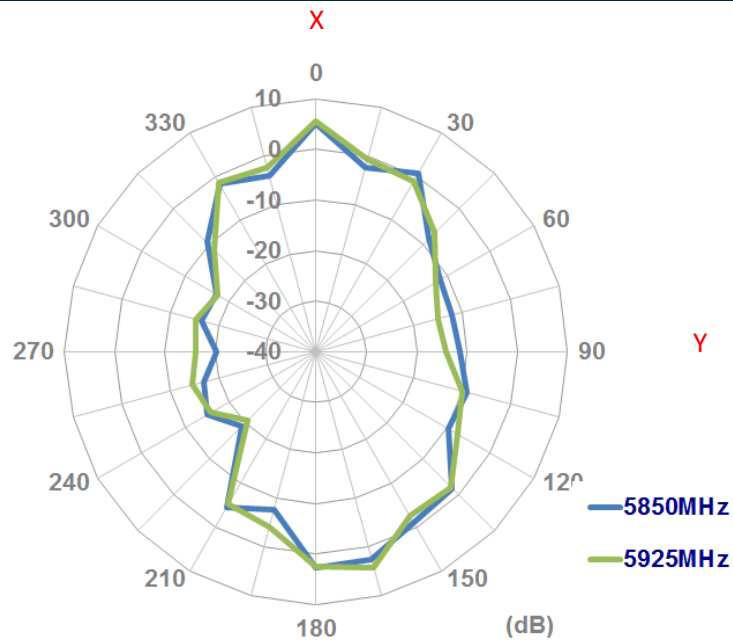

XZ Plane YZ Plane

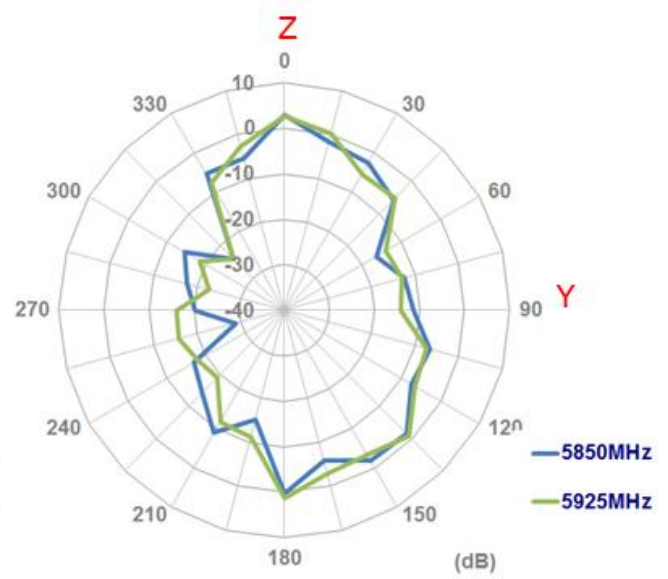
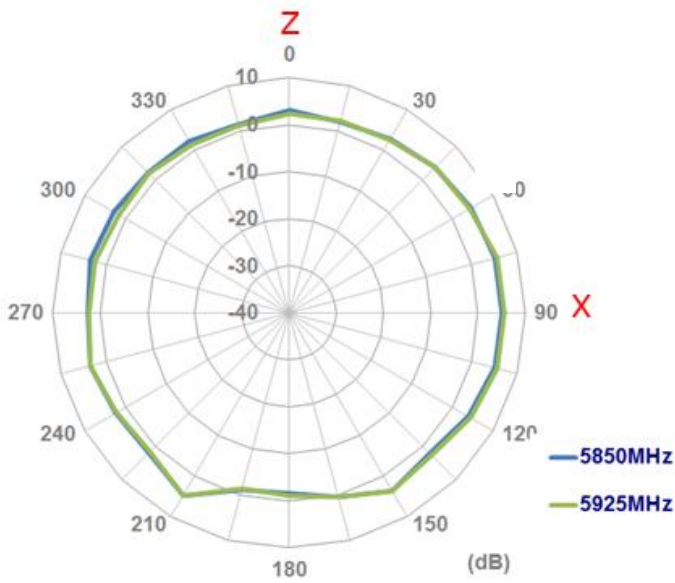

4.3 Test Setup

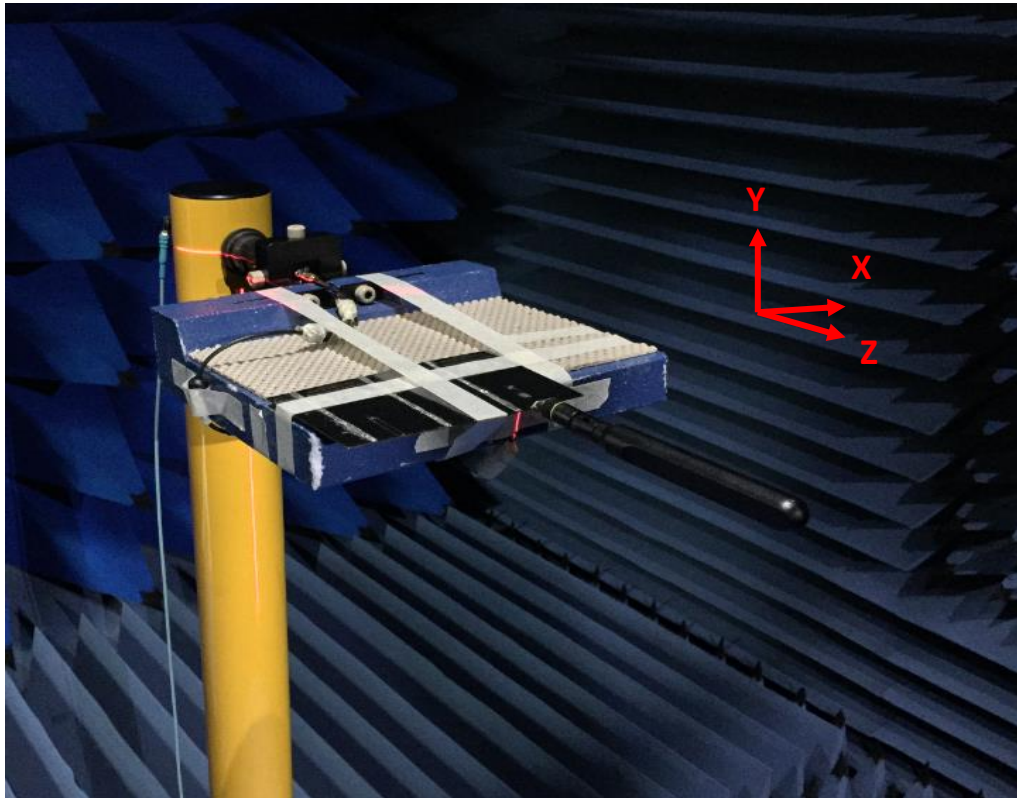

straight with 15*9cm ground plane

XY Plane

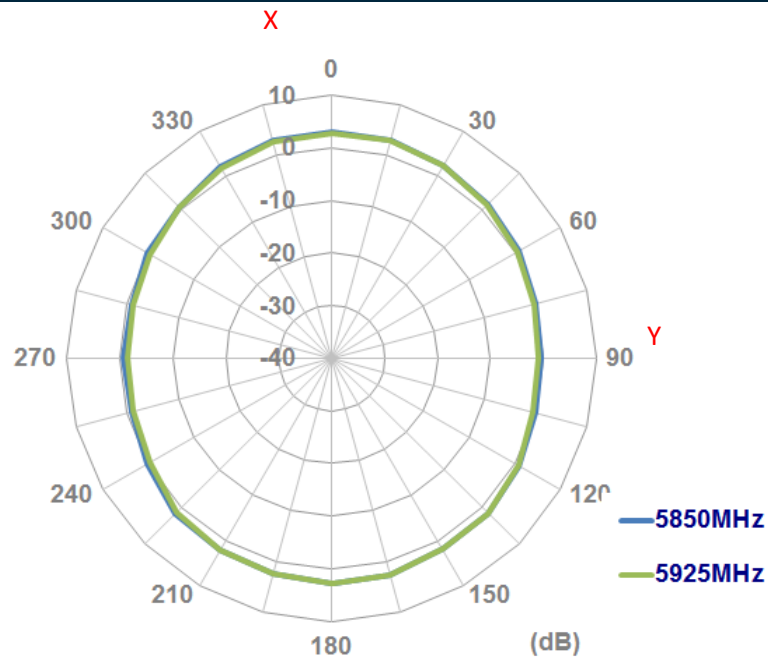

XZ Plane

YZ Plane

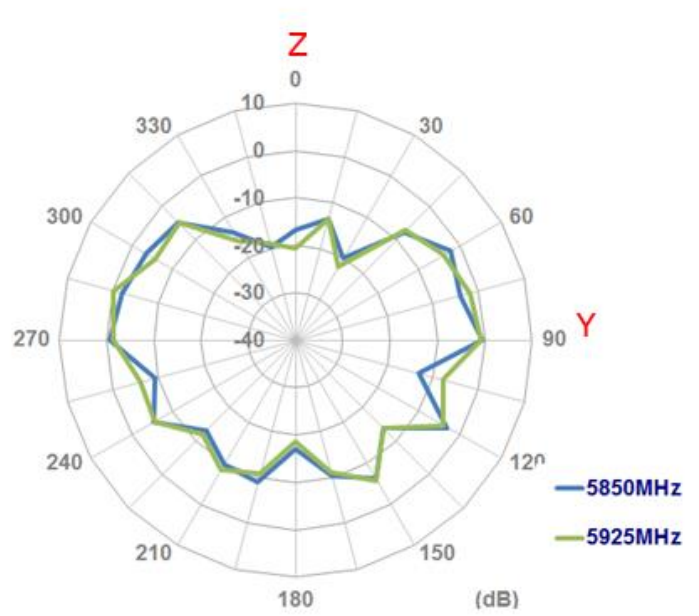
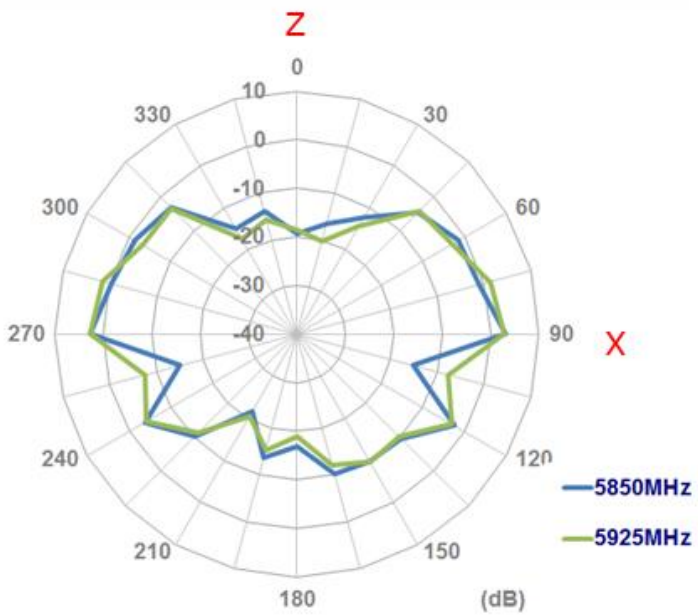

4.4 Test Setup

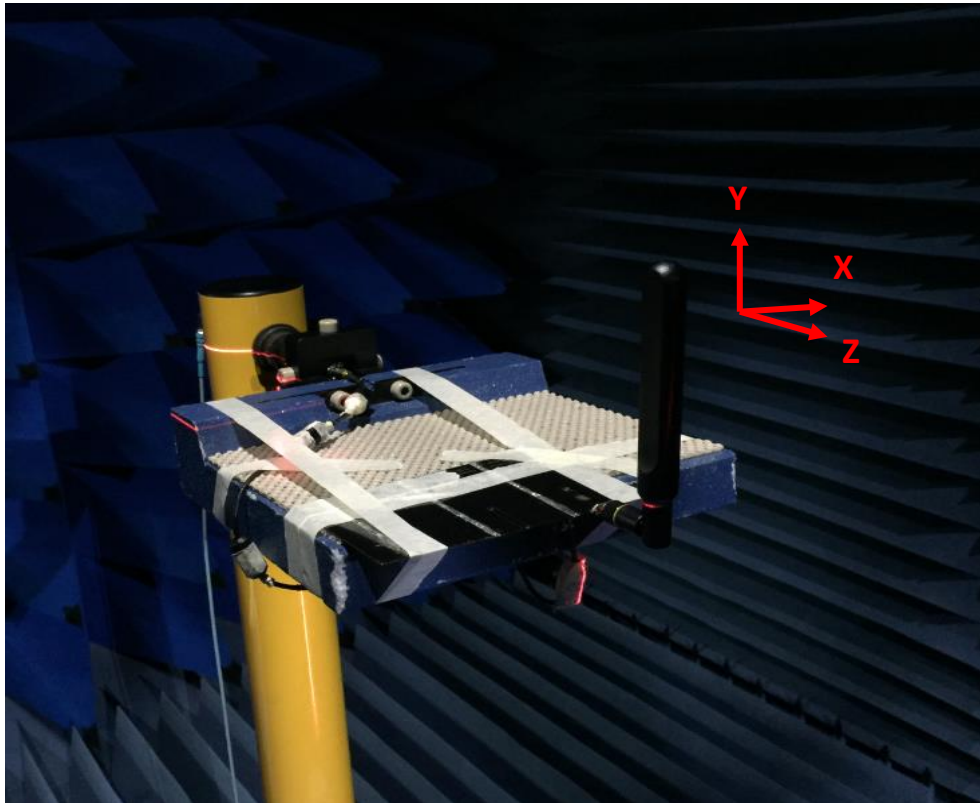

bent with 15*9cm ground plane

XY Plane

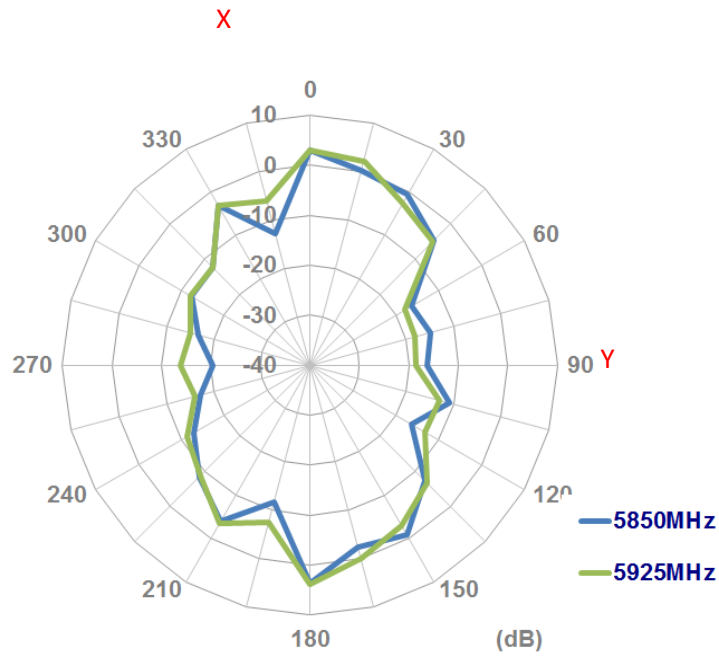

XZ Plane

YZ Plane

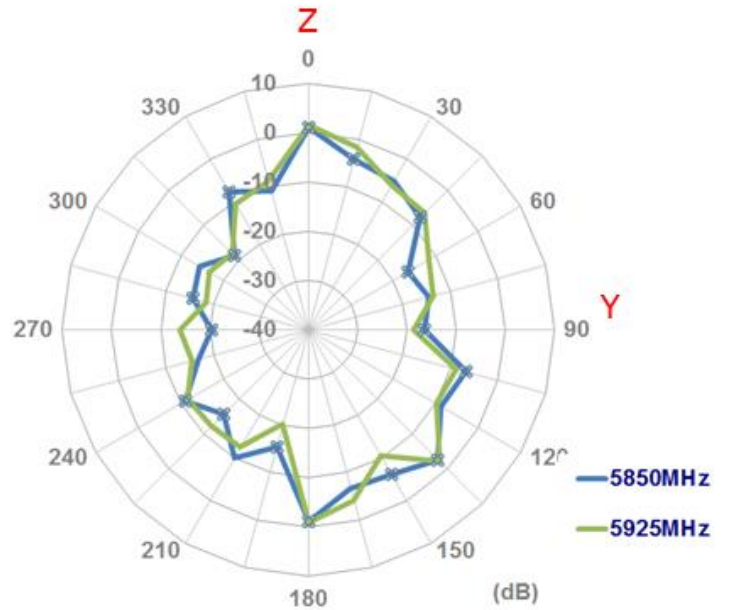
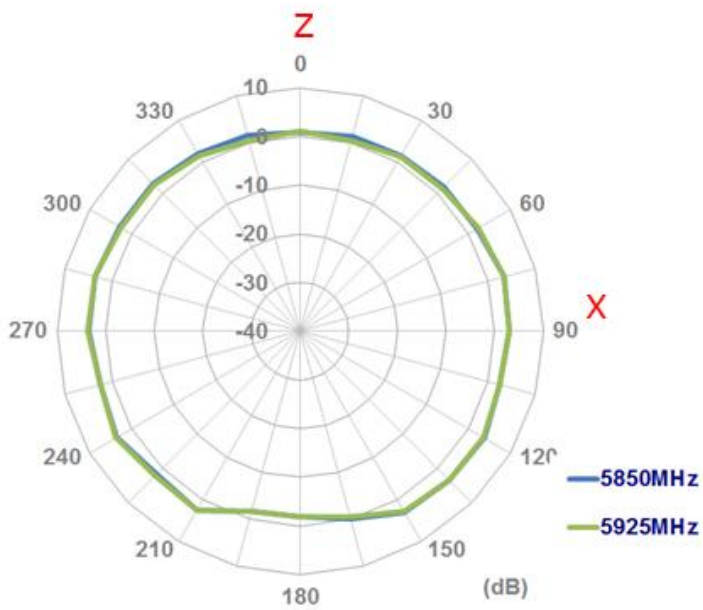

4.4 Test Setup

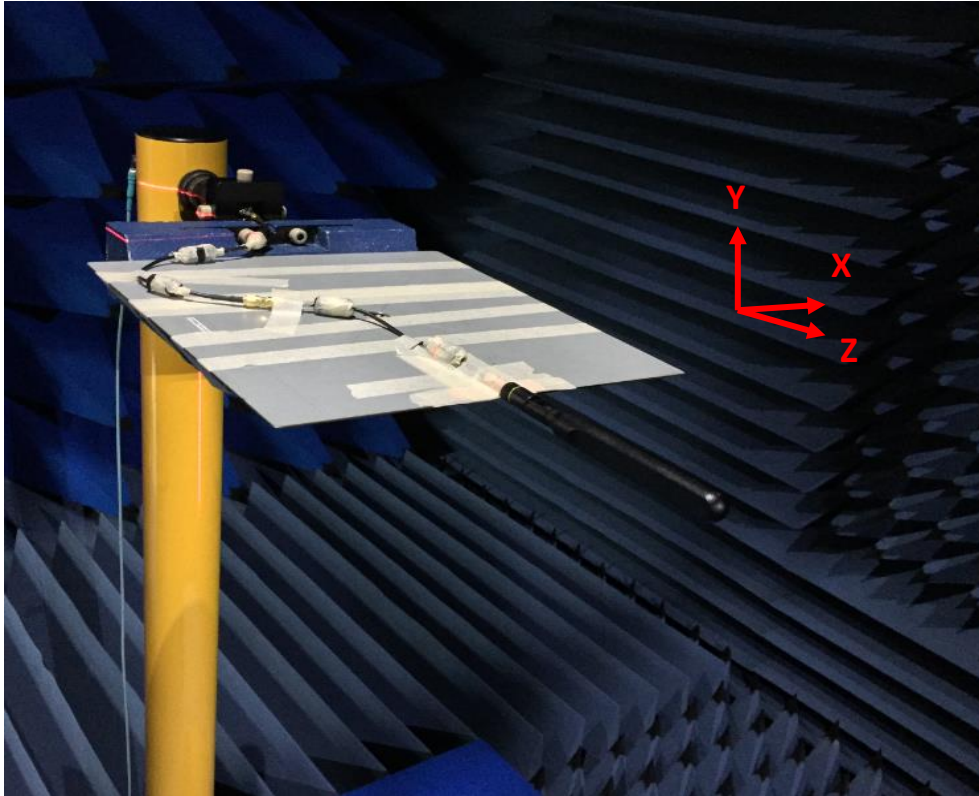

Straight with 30*30cm Ground Plane edge

XY Plane

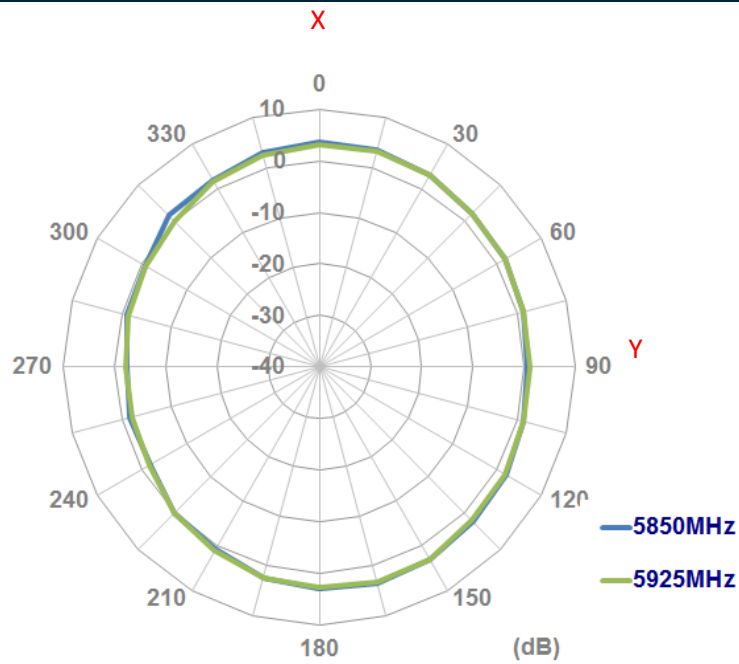

XZ Plane

YZ Plane

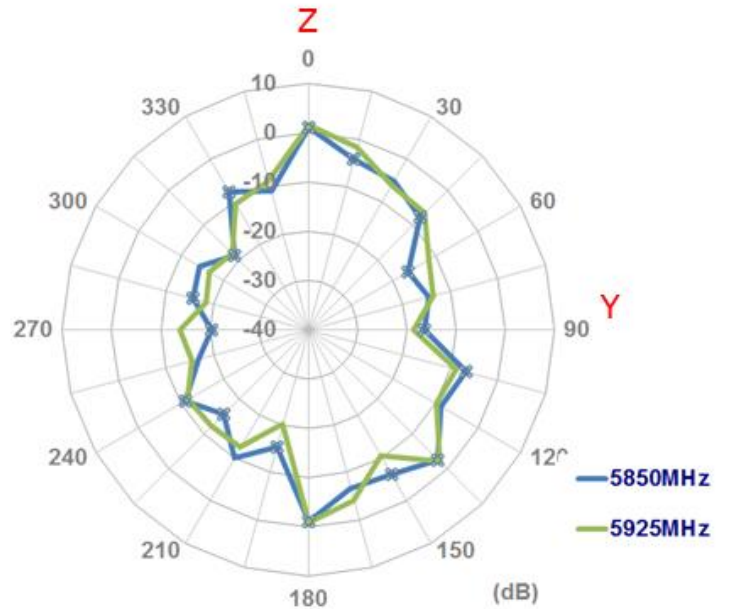
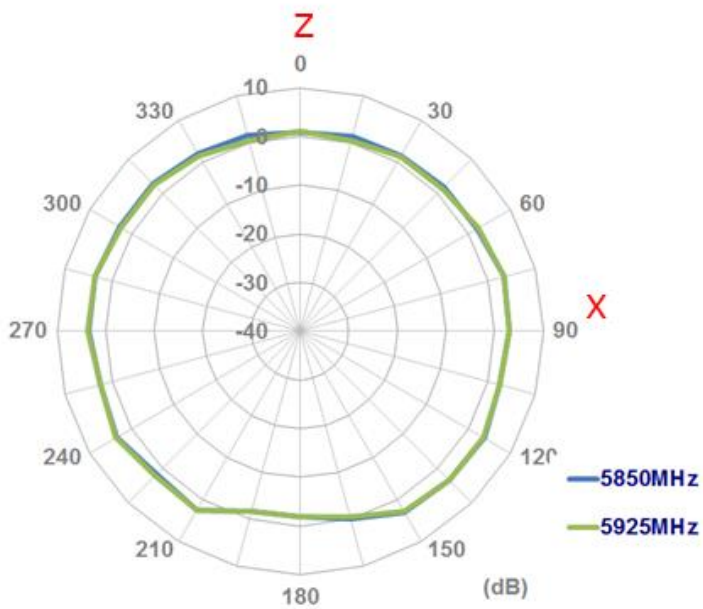

4.5 Test Setup

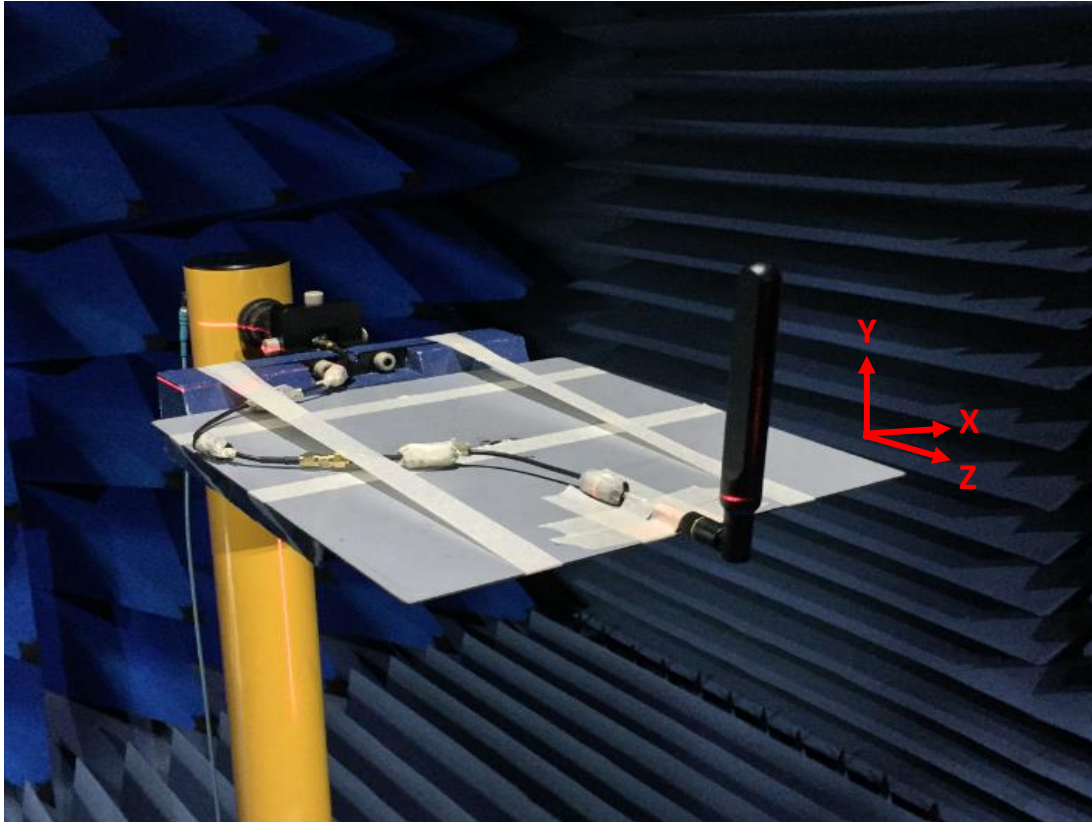

Bent with 30*30cm Ground Plane edge

XY Plane

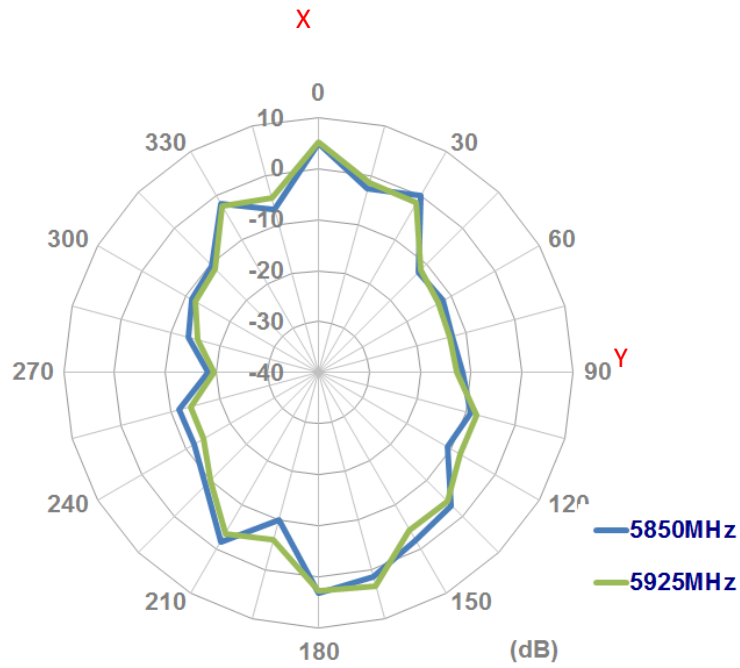

XZ Plane

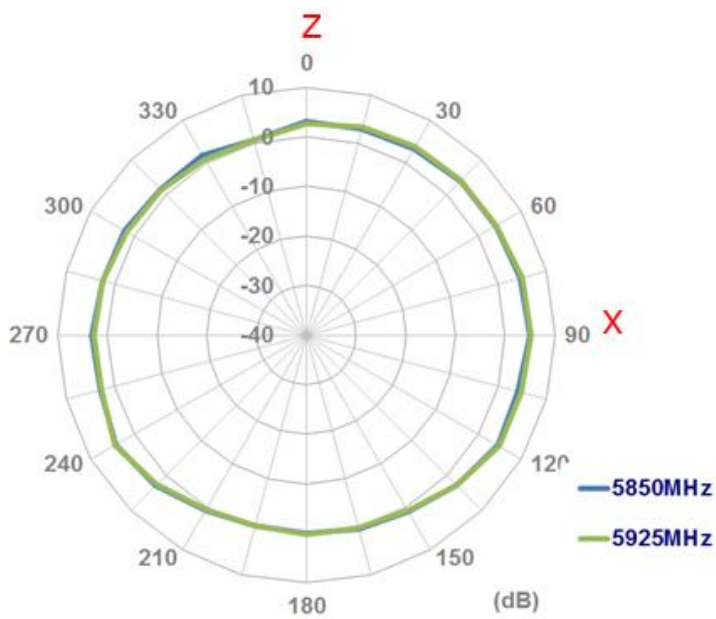

YZ Plane

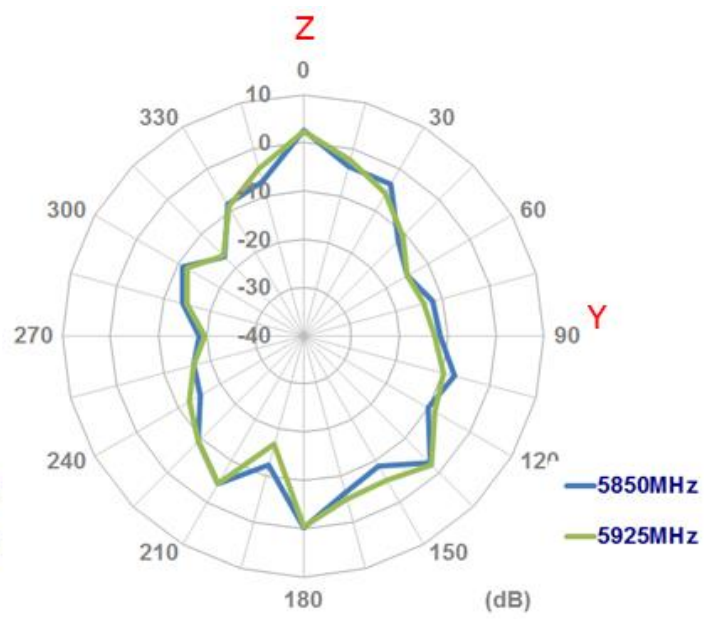

4.6 Test Setup

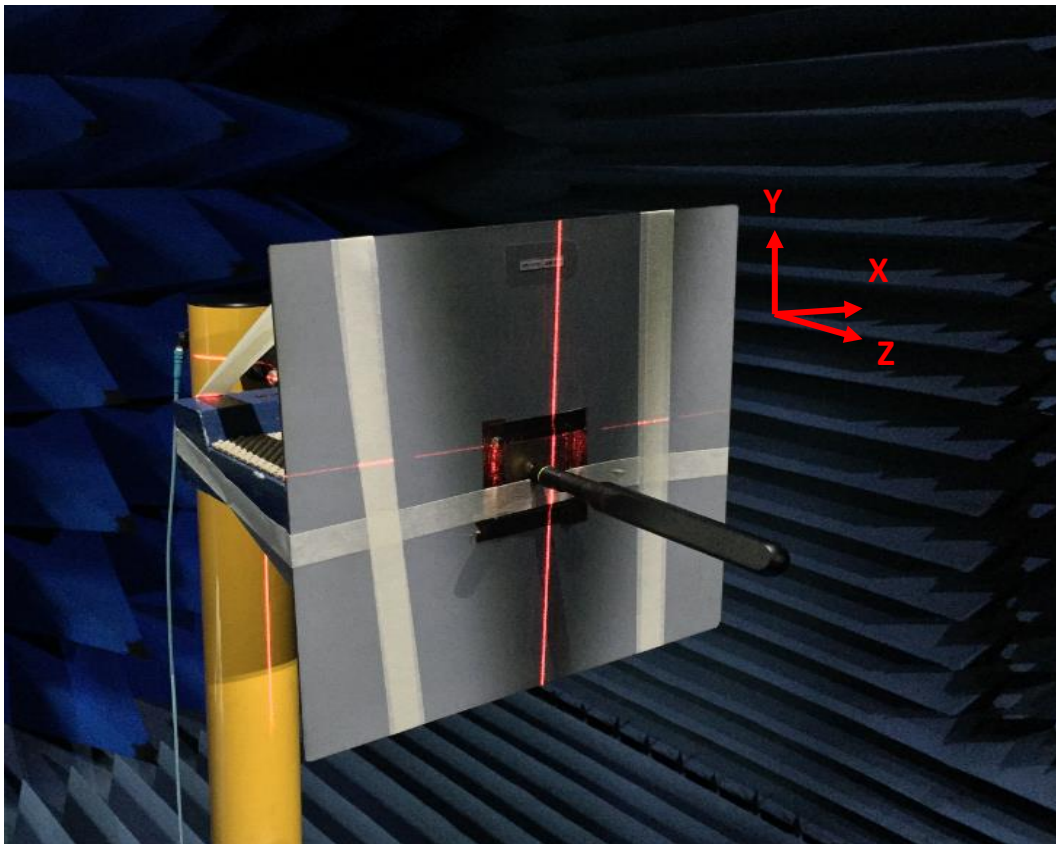

Straight with 30*30cm Ground Plane Center

XY Plane

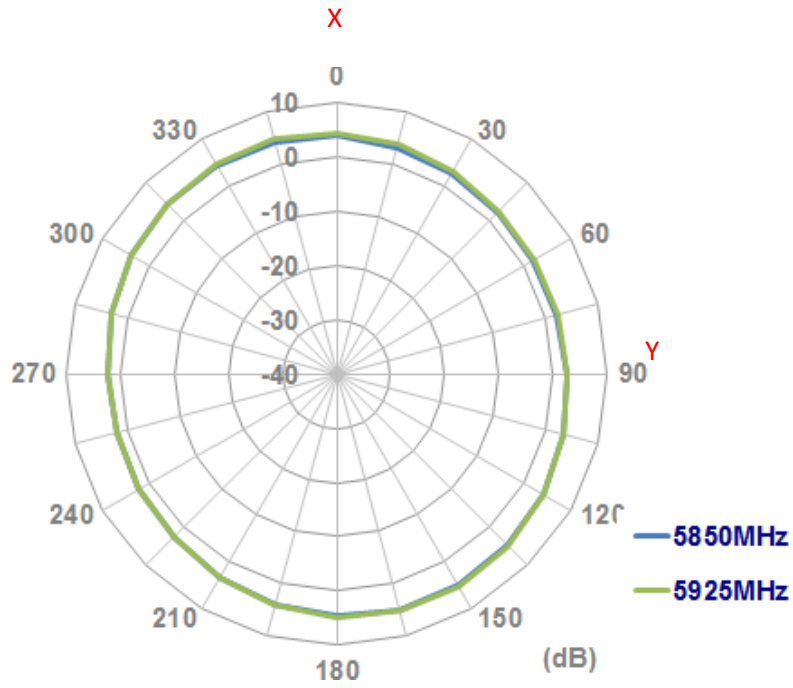

XZ Plane

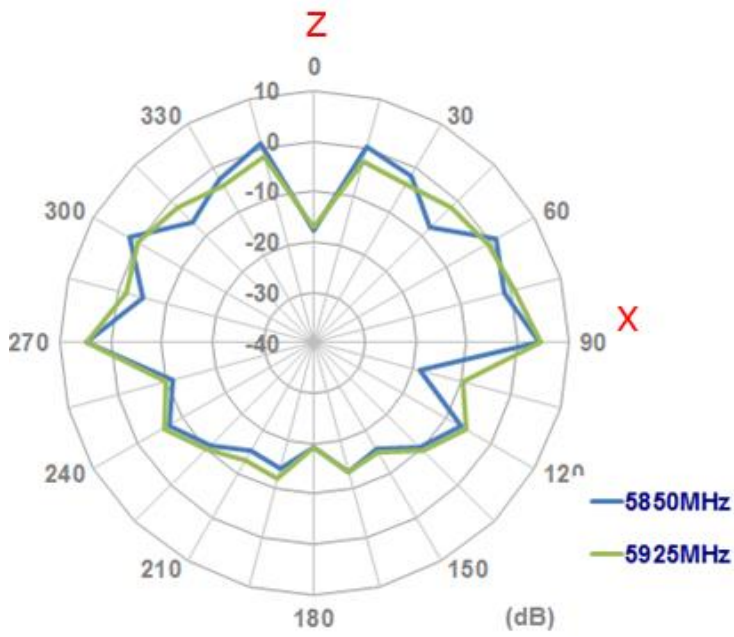

YZ Plane

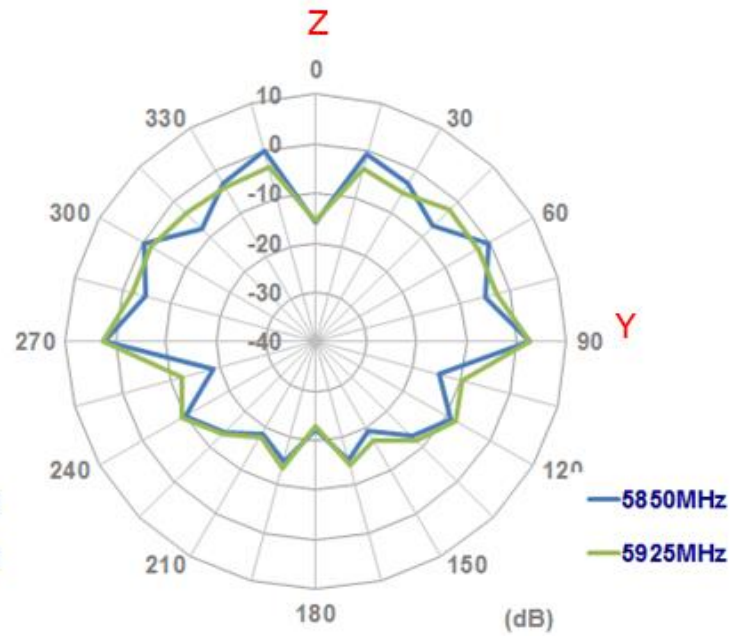

4.7 Test Setup

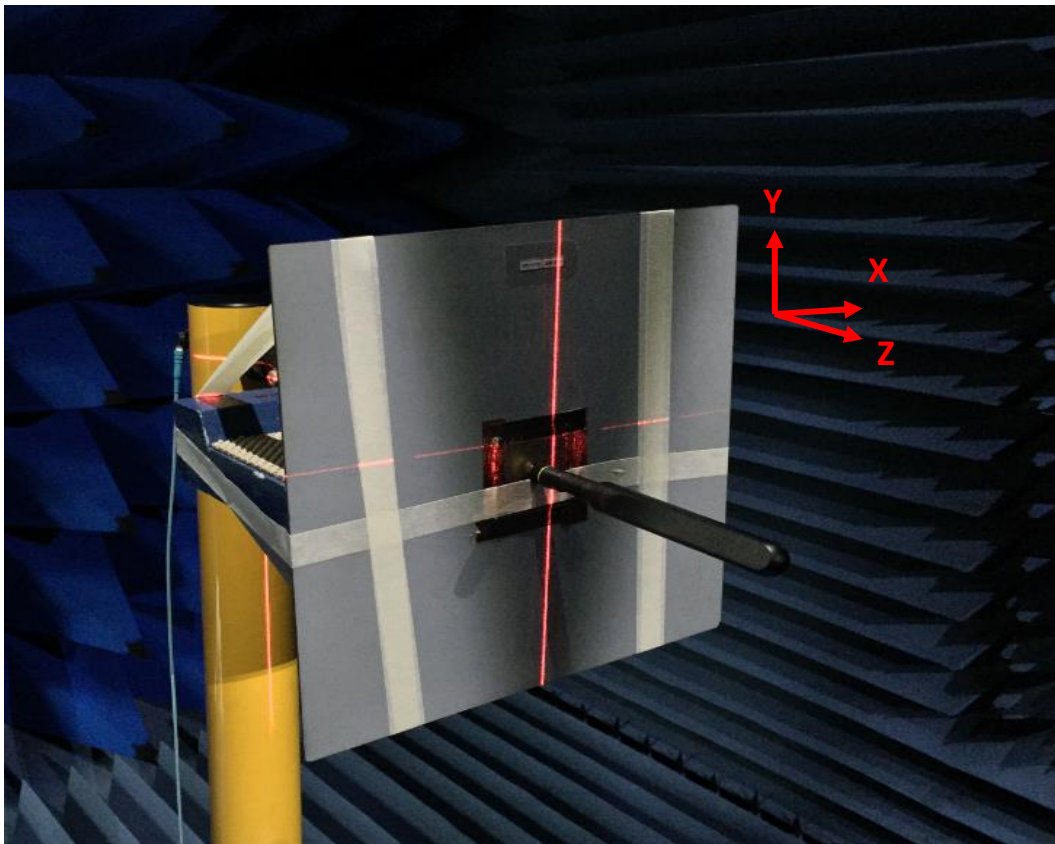

Bent at 90° with 30*30cm Ground Plane Center

XY Plane

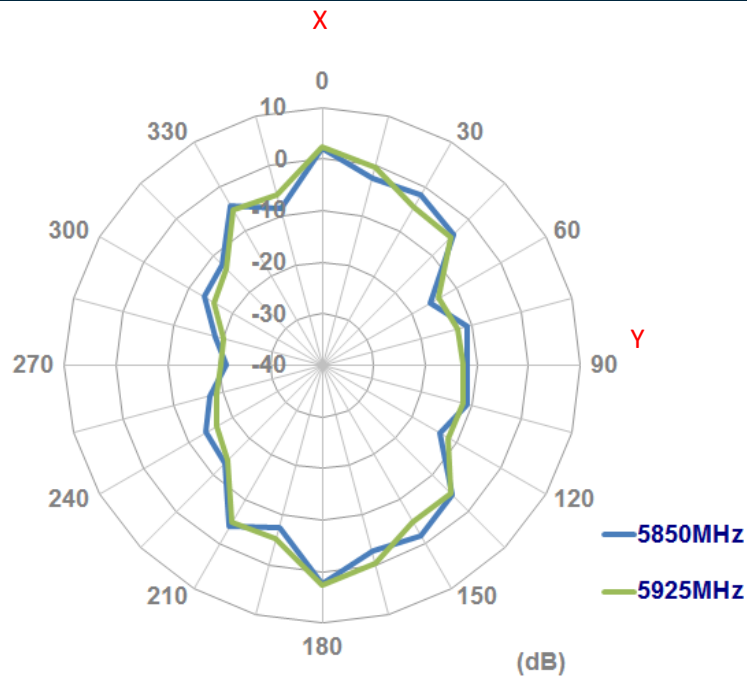

XZ Plane

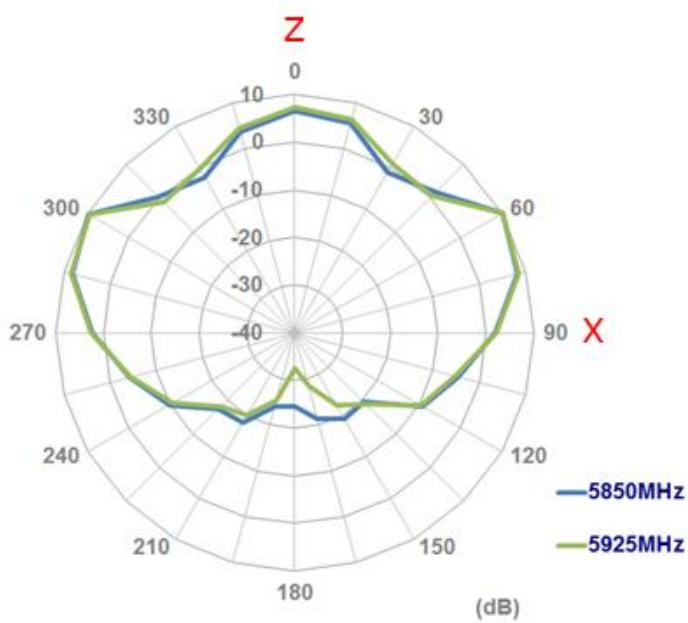

YZ Plane

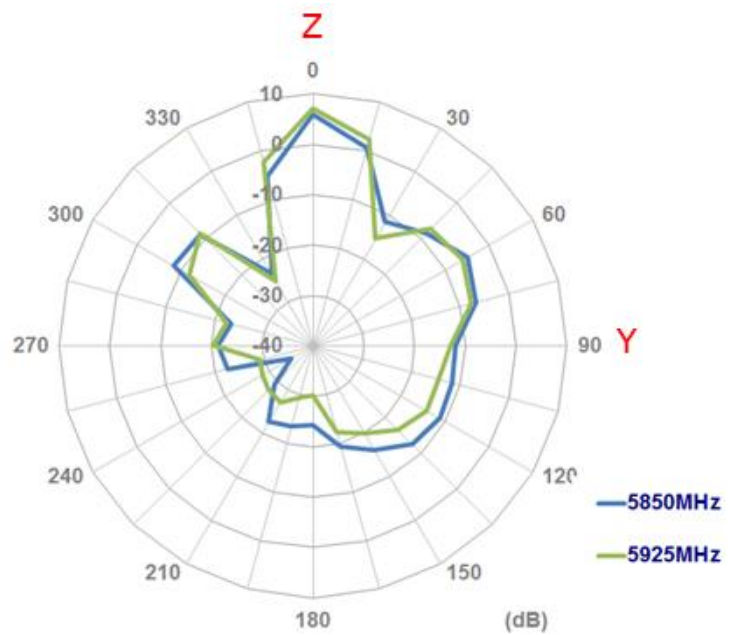

5. 3D Radiation Patterns

5.1 Free Space

Straight

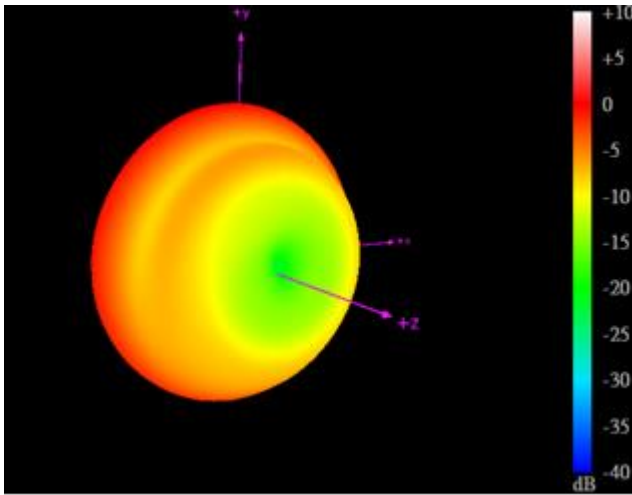

5850MHz

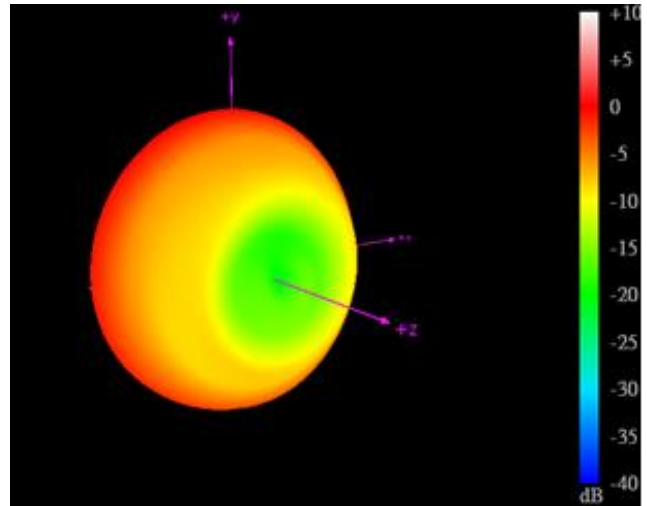

5925MHz

Bent at 90 Degrees

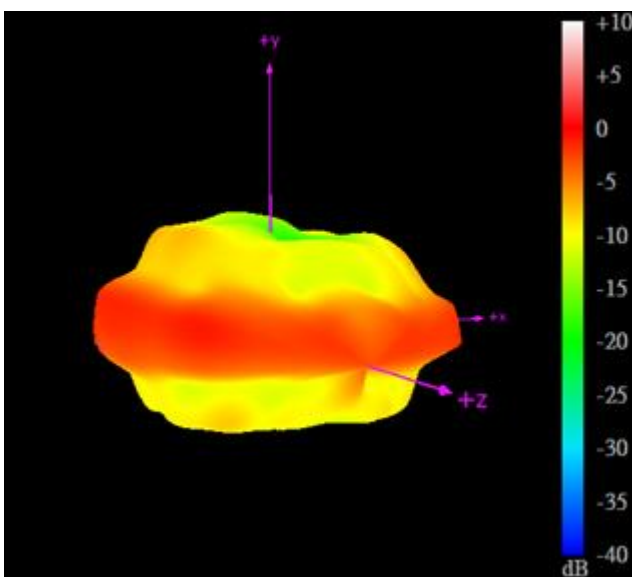

5850MHz

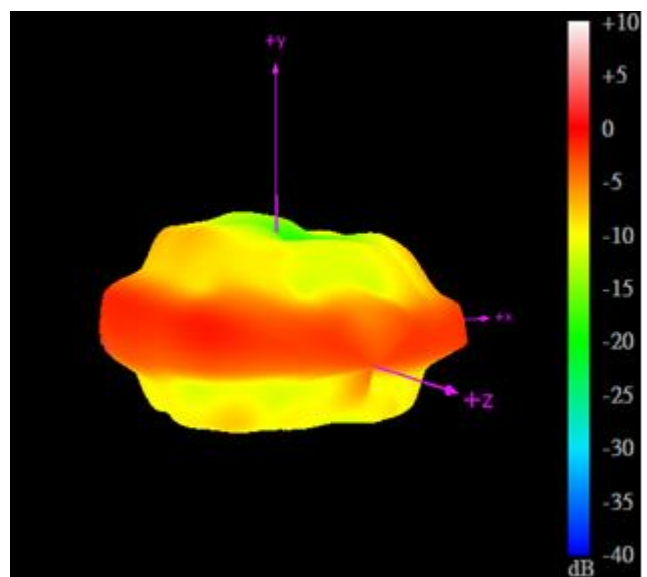

5925MHz

5.2 15*9cm Ground Plane

Straight

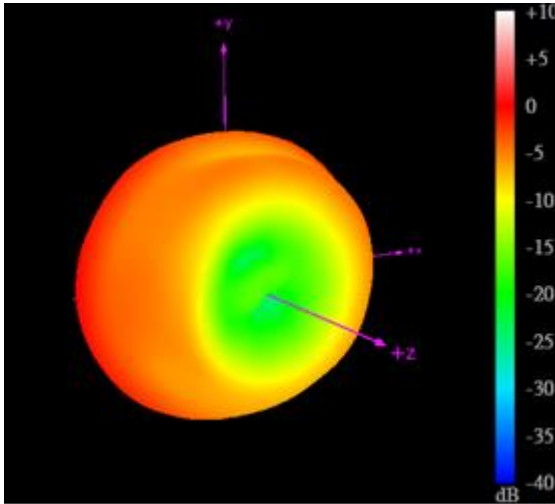

5850MHz

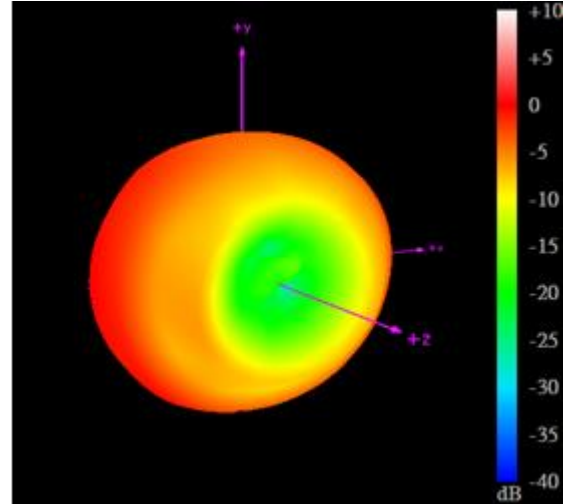

5925MHz

Bent at 90 Degrees

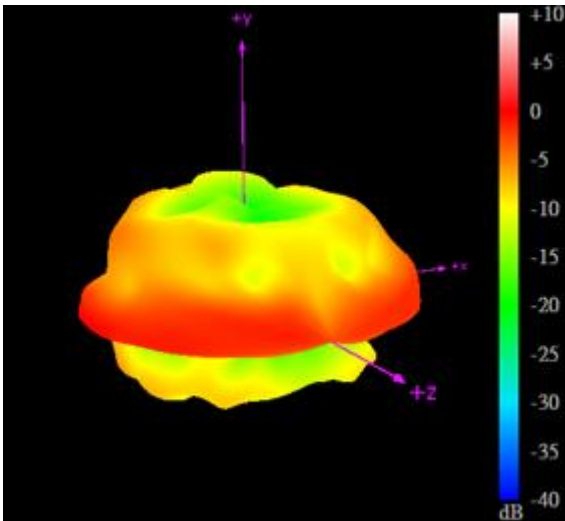

5850MHz

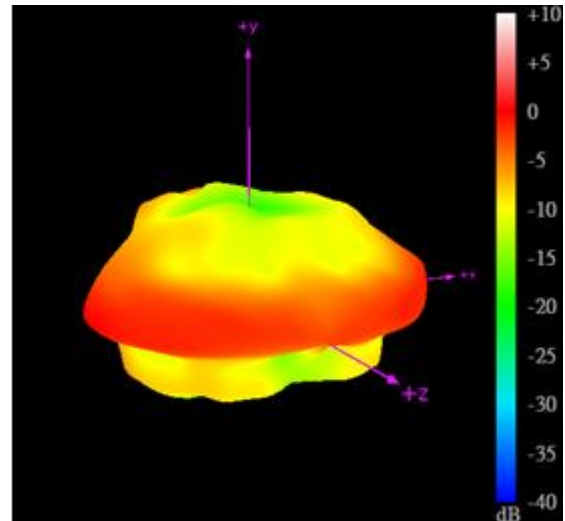

5925MHz

5.3 30*30cm Ground Plane edge

Straight

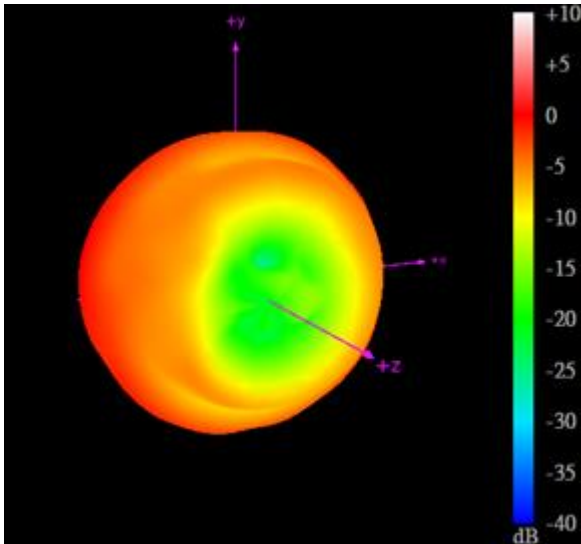

5850MHz

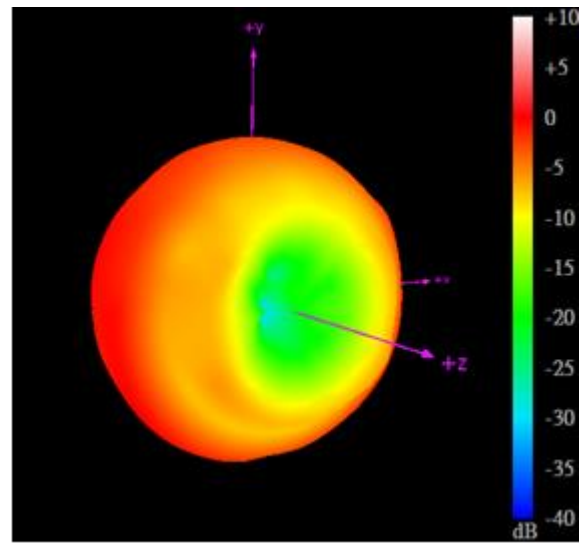

5925MHz

Bent at 90 Degrees

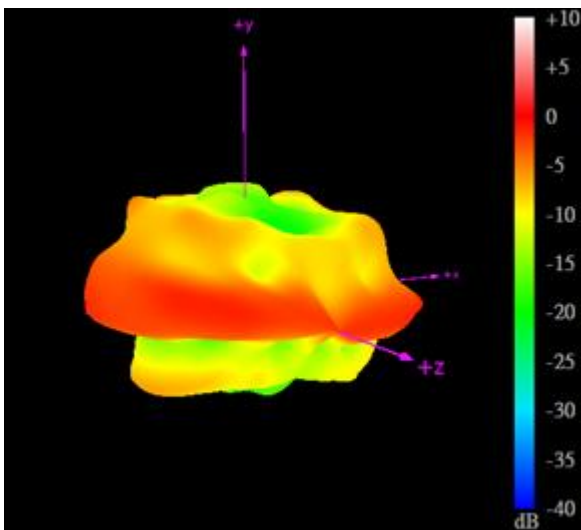

5850MHz

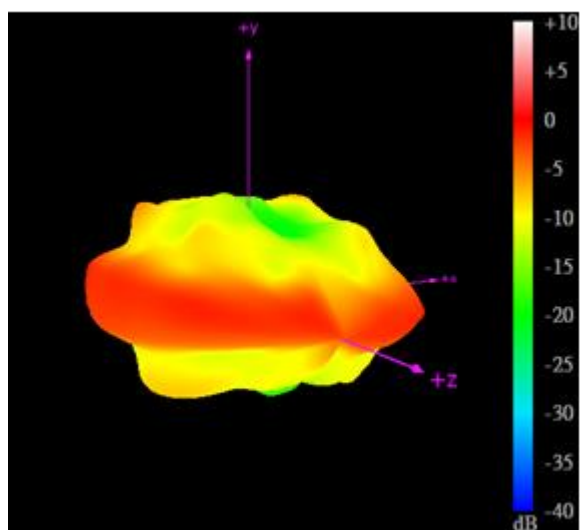

5925MHz

5.4 30*30cm Ground Plane Center

Straight

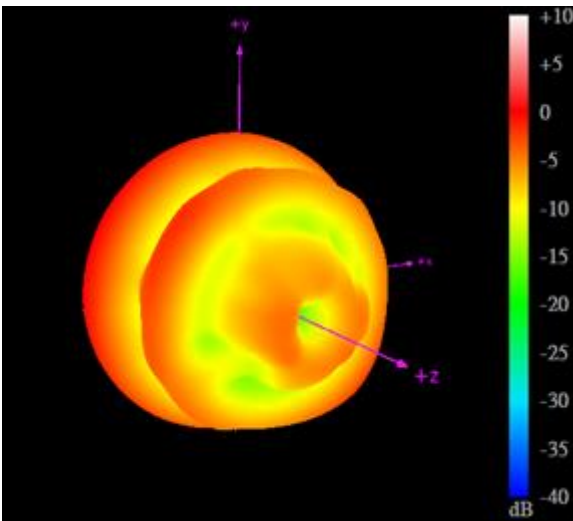

5850MHz

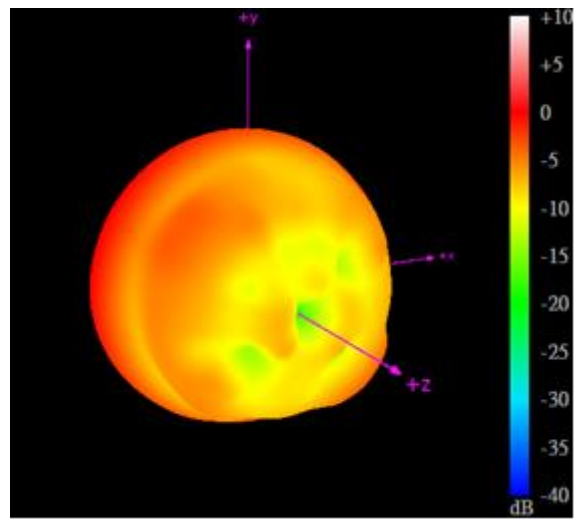

5925MHz

Bent at 90 Degrees

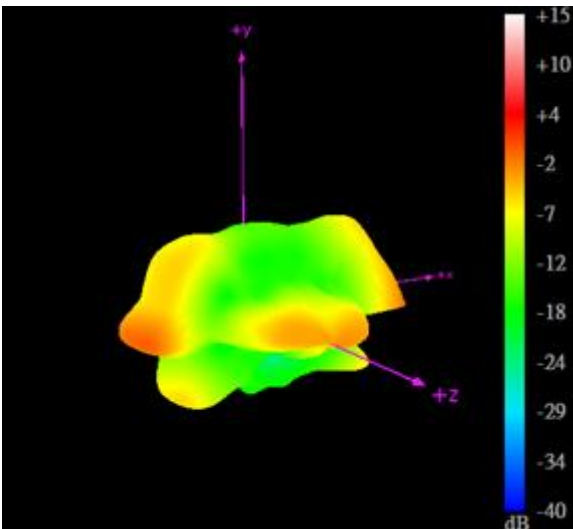

5850MHz

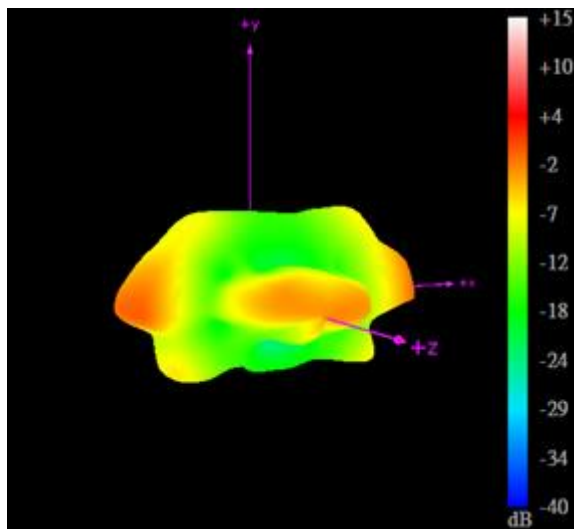

5925MHz

6. Mechanical Drawing (Units: mm)

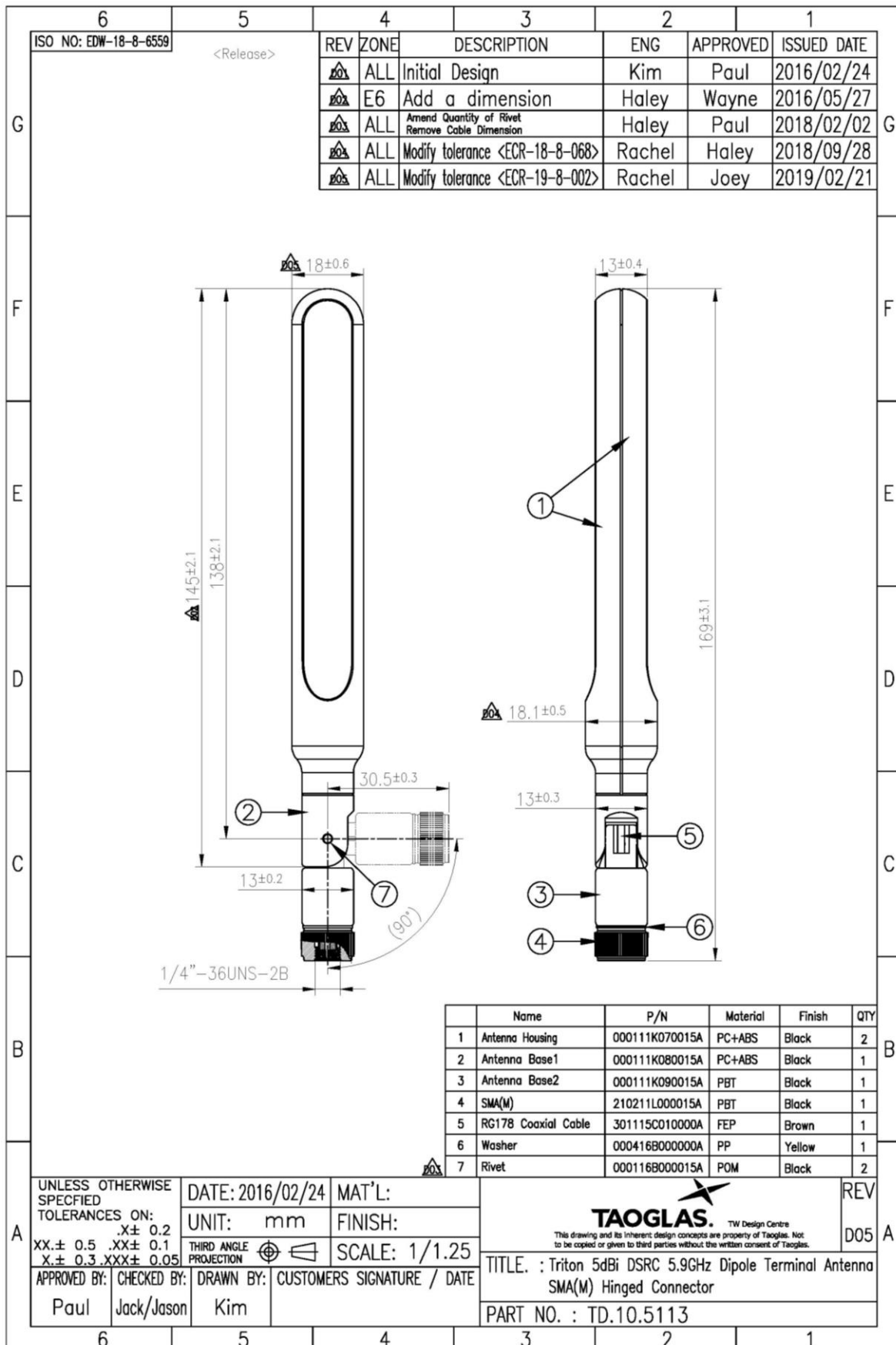

7. Packaging

1 pc TD.10.5113 per PE bag
 PE Bag Dimensions - 240*100mm
 Weight - 200g

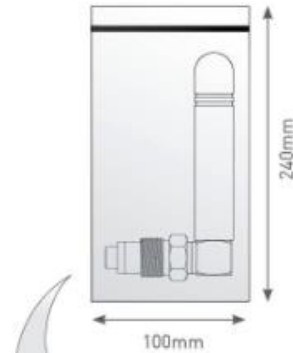

50 pcs TD.10.5113 per Large PE bag
 PE Bag Dimensions - 440*240mm
 Weight - 1.1kg

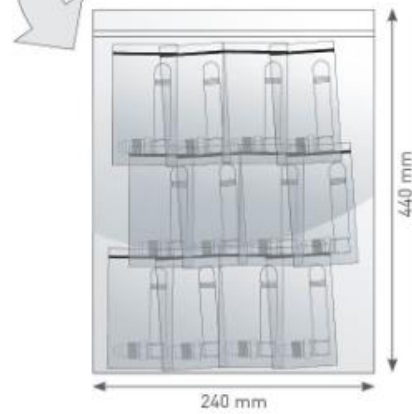

300 pcs TD.10.5113 per carton
 Carton Dimensions - 400*340*220mm
 Weight - 7.7kg

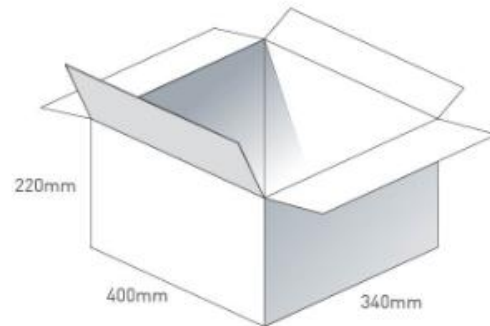

Pallet Dimensions 1200*1000*1500mm
 54 Cartons per Pallet
 6 Cartons per layer
 9 Layers

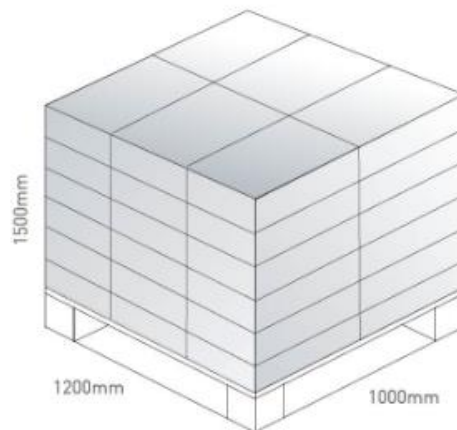

Changelog for the datasheet

SPE-16-8-063 – TD.10.5113

Revision: B (Current Version)

Date:	2019-02-27
Changes:	Installation Guide Amended
Changes Made by:	Jack Conroy

Previous Revisions

Revision: A (Original First Release)

Date:	2016-09-27
Notes:	
Author:	Your Name Here



TAOGLAS®

www.taoglas.com

