

## Data sheet | Item number: 2022-1807

4-pin ground carrier terminal block; for DIN-rail 35 x 15 and 35 x 7.5; green-yellow

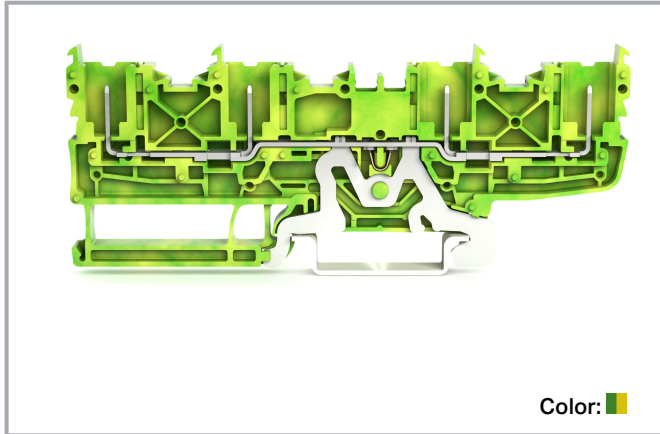

[www.wago.com/2022-1807](http://www.wago.com/2022-1807)



Color:

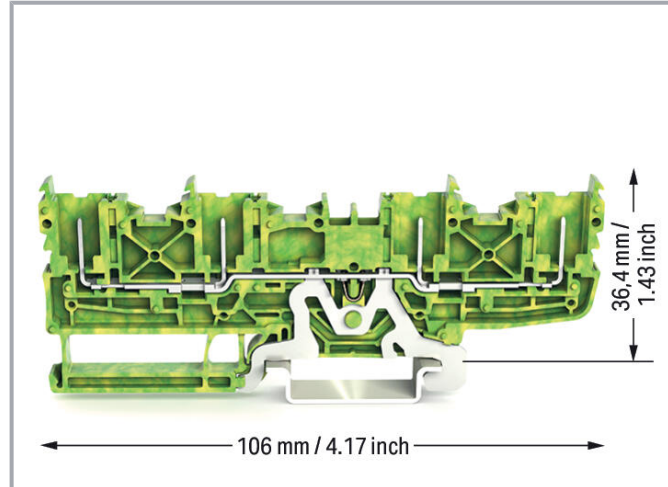

### Data

#### Electrical data

#### Ratings per IEC/EN

Ratings per IEC/EN 60947-7-2

#### Connection data

Female plug slots	4
Total number of potentials	1
Number of levels	1

#### Physical data

Width	5.2 mm / 0.205 inches
Height	106 mm / 4.173 inches
Depth from upper-edge of DIN-rail	32.5 mm / 1.28 inches

#### Mechanical Data

Design	horizontal type
Mounting type	DIN-35 rail

Subject to changes. Please also observe the further product documentation!

WAGO GmbH & Co. KG  
Hansastr. 27  
32423 Minden  
Phone: +49571 887-0 | Fax: +49571 887-169  
Email: [info.de@wago.com](mailto:info.de@wago.com) | Web: [www.wago.com](http://www.wago.com)

Do you have any questions about our products?  
We are always happy to take your call at +49 (571) 887-44222.

Marking level

Center/side marking

## Material Data

Note (material data)

Information on material specifications can be found here

Color	green-yellow
Material group	I
Insulation material	Polyamide (PA66)
Flammability class per UL94	V0
Weight	14.7 g

## Environmental requirements

Continuous operating temperature

-60 ... +105 °C

## Commercial data

ETIM 8.0	EC000901
ETIM 7.0	EC000901
PU (SPU)	50 pcs
Packaging type	Box
Country of origin	CN
GTIN	4055143927123
Customs tariff number	85366990990

## Environmental Product Compliance

RoHS Compliance Status

Compliant, No Exemption



## Approvals / Certificates

### General approvals



Logo	Approval	Additional Approval Text	Certificate name
	CCA DEKRA Certification B.V.	C22.2 No. 158	2437422
	CCA DEKRA Certification B.V.	EN 60947	NTR CCA NL-7864

Subject to changes. Please also observe the further product documentation!

CCA

	KEMA/KEUR DEKRA Certification B.V.	EN 60947	71- 116567
	UL Underwriters Laboratories Inc.	UL 1059	E45172

### Counterpart

	Item no.2022-101 1-conductor female connector; Push-in CAGE CLAMP®; 4 mm²; Pin spacing 5.2 mm; 1-pole; 4,00 mm²; gray	<a href="http://www.wago.com/2022-101">www.wago.com/2022-101</a>
	Item no.2022-101/000-016 1-conductor female connector; Push-in CAGE CLAMP®; 4 mm²; Pin spacing 5.2 mm; 1-pole; 4,00 mm²; green-yellow	<a href="http://www.wago.com/2022-101/000-016">www.wago.com/2022-101/000-016</a>



### Required accessories

#### End plate

End plate	Item no.: 2022-1891 End plate; 1 mm thick; gray	<a href="http://www.wago.com/2022-1891">www.wago.com/2022-1891</a>
	Item no.: 2022-1892 End plate; 1 mm thick; orange	<a href="http://www.wago.com/2022-1892">www.wago.com/2022-1892</a>

### Optional accessories

#### Carrier rail

Mounting accessories	Item no.: 210-197 Steel carrier rail; 35 x 15 mm; 1.5 mm thick; 2 m long; slotted; similar to EN 60715; silver-colored	<a href="http://www.wago.com/210-197">www.wago.com/210-197</a>
	Item no.: 210-198 Copper carrier rail; 35 x 15 mm; 2.3 mm thick; 2 m long; unslotted; according to EN 60715; copper-colored	<a href="http://www.wago.com/210-198">www.wago.com/210-198</a>
	Item no.: 210-113 Steel carrier rail; 35 x 7.5 mm; 1 mm thick; 2 m long; unslotted; according to EN 60715; silver-colored	<a href="http://www.wago.com/210-113">www.wago.com/210-113</a>

Subject to changes. Please also observe the further product documentation!



**Item no.: 210-118**

Steel carrier rail; 35 x 15 mm; 2.3 mm thick; 2 m long; unslotted; according to EN 60715; silver-colored [www.wago.com/210-118](http://www.wago.com/210-118)



**Item no.: 210-112**

Steel carrier rail; 35 x 7.5 mm; 1 mm thick; 2 m long; slotted; according to EN 60715; "Hole width 25 mm; silver-colored [www.wago.com/210-112](http://www.wago.com/210-112)



**Item no.: 210-114**

Steel carrier rail; 35 x 15 mm; 1.5 mm thick; 2 m long; unslotted; similar to EN 60715; silver-colored [www.wago.com/210-114](http://www.wago.com/210-114)



**Item no.: 210-115**

Steel carrier rail; 35 x 7.5 mm; 1 mm thick; 2 m long; slotted; according to EN 60715; "Hole width 18 mm; silver-colored [www.wago.com/210-115](http://www.wago.com/210-115)



**Item no.: 210-196**

Aluminum carrier rail; 35 x 8.2 mm; 1.6 mm thick; 2 m long; unslotted; similar to EN 60715; silver-colored [www.wago.com/210-196](http://www.wago.com/210-196)

**Jumpers**

Jumper



**Item no.: 2002-402**

Jumper; 2-way; insulated; light gray [www.wago.com/2002-402](http://www.wago.com/2002-402)



**Item no.: 2002-402/000-005**

Jumper; 2-way; insulated; red [www.wago.com/2002-402/000-005](http://www.wago.com/2002-402/000-005)



**Item no.: 2002-400**

Continuous jumper; 2-way; insulated; light gray [www.wago.com/2002-400](http://www.wago.com/2002-400)



**Item no.: 2002-403**

Jumper; 3-way; insulated; light gray [www.wago.com/2002-403](http://www.wago.com/2002-403)



**Item no.: 2002-404/000-005**

Jumper; 4-way; insulated; red [www.wago.com/2002-404/000-005](http://www.wago.com/2002-404/000-005)



**Item no.: 2002-403/000-006**

Jumper; 3-way; insulated; blue [www.wago.com/2002-403/000-006](http://www.wago.com/2002-403/000-006)



**Item no.: 2002-404/000-006**

Jumper; 4-way; insulated; blue [www.wago.com/2002-404/000-006](http://www.wago.com/2002-404/000-006)



**Item no.: 2002-403/000-005**

Jumper; 3-way; insulated; red [www.wago.com/2002-403/000-005](http://www.wago.com/2002-403/000-005)



**Item no.: 2002-405/000-005**

Jumper; 5-way; insulated; red [www.wago.com/2002-405/000-005](http://www.wago.com/2002-405/000-005)

Subject to changes. Please also observe the further product documentation!

WAGO GmbH & Co. KG

Hansastr. 27













32423 Minden

Phone: +49571 887-0 | Fax: +49571 887-169

Email: [info.de@wago.com](mailto:info.de@wago.com) | Web: [www.wago.com](http://www.wago.com)

Do you have any questions about our products?

We are always happy to take your call at +49 (571) 887-44222.

	<b>Item no.:</b> 2002-402/000-006 Jumper; 2-way; insulated; blue	<a href="http://www.wago.com/2002-402/000-006">www.wago.com/2002-402/000-006</a>
	<b>Item no.:</b> 2002-405/000-006 Jumper; 5-way; insulated; blue	<a href="http://www.wago.com/2002-405/000-006">www.wago.com/2002-405/000-006</a>
	<b>Item no.:</b> 2002-404 Jumper; 4-way; insulated; light gray	<a href="http://www.wago.com/2002-404">www.wago.com/2002-404</a>
	<b>Item no.:</b> 2002-406/000-006 Jumper; 6-way; insulated; blue	<a href="http://www.wago.com/2002-406/000-006">www.wago.com/2002-406/000-006</a>
	<b>Item no.:</b> 2002-406/000-005 Jumper; 6-way; insulated; red	<a href="http://www.wago.com/2002-406/000-005">www.wago.com/2002-406/000-005</a>
	<b>Item no.:</b> 2002-406/020-000 Delta jumper; insulated; light gray	<a href="http://www.wago.com/2002-406/020-000">www.wago.com/2002-406/020-000</a>
	<b>Item no.:</b> 2002-405 Jumper; 5-way; insulated; light gray	<a href="http://www.wago.com/2002-405">www.wago.com/2002-405</a>
	<b>Item no.:</b> 2002-407/000-005 Jumper; 7-way; insulated; red	<a href="http://www.wago.com/2002-407/000-005">www.wago.com/2002-407/000-005</a>
	<b>Item no.:</b> 2002-408 Jumper; 8-way; insulated; light gray	<a href="http://www.wago.com/2002-408">www.wago.com/2002-408</a>
	<b>Item no.:</b> 2002-408/000-006 Jumper; 8-way; insulated; blue	<a href="http://www.wago.com/2002-408/000-006">www.wago.com/2002-408/000-006</a>
	<b>Item no.:</b> 2002-405/011-000 Star point jumper; 3-way; insulated; light gray	<a href="http://www.wago.com/2002-405/011-000">www.wago.com/2002-405/011-000</a>
	<b>Item no.:</b> 2002-407/000-006 Jumper; 7-way; insulated; blue	<a href="http://www.wago.com/2002-407/000-006">www.wago.com/2002-407/000-006</a>

Subject to changes. Please also observe the further product documentation!



**Item no.: 2002-408/000-005**  
Jumper; 8-way; insulated; red

[www.wago.com/2002-408/000-005](http://www.wago.com/2002-408/000-005)



**Item no.: 2002-407**  
Jumper; 7-way; insulated; light gray

[www.wago.com/2002-407](http://www.wago.com/2002-407)



**Item no.: 2002-406**  
Jumper; 6-way; insulated; light gray

[www.wago.com/2002-406](http://www.wago.com/2002-406)



**Item no.: 2002-410/000-005**  
Jumper; 10-way; insulated; red

[www.wago.com/2002-410/000-005](http://www.wago.com/2002-410/000-005)



**Item no.: 2002-410/000-006**  
Jumper; 10-way; insulated; blue

[www.wago.com/2002-410/000-006](http://www.wago.com/2002-410/000-006)



**Item no.: 2002-410**  
Jumper; 10-way; insulated; light gray

[www.wago.com/2002-410](http://www.wago.com/2002-410)



**Item no.: 2002-409/000-006**  
Jumper; 9-way; insulated; blue

[www.wago.com/2002-409/000-006](http://www.wago.com/2002-409/000-006)



**Item no.: 2002-409/000-005**  
Jumper; 9-way; insulated; red

[www.wago.com/2002-409/000-005](http://www.wago.com/2002-409/000-005)



**Item no.: 2002-409**  
Jumper; 9-way; insulated; light gray

[www.wago.com/2002-409](http://www.wago.com/2002-409)



**Item no.: 2002-423/000-006**  
Continuous jumper; from 1 to 3; insulated; blue

[www.wago.com/2002-423/000-006](http://www.wago.com/2002-423/000-006)



**Item no.: 2002-423**  
Continuous jumper; from 1 to 3; insulated; light gray

[www.wago.com/2002-423](http://www.wago.com/2002-423)



**Item no.: 2002-433**  
Jumper; from 1 to 3; insulated; light gray

[www.wago.com/2002-433](http://www.wago.com/2002-433)

















**Item no.: 2002-434**  
Jumper; from 1 to 4; insulated; light gray













[www.wago.com/2002-434](http://www.wago.com/2002-434)



Subject to changes. Please also observe the further product documentation!

	<p><b>Item no.: 2002-423/000-005</b> Continuous jumper; from 1 to 3; insulated; red</p>	<p><a href="http://www.wago.com/2002-423/000-005">www.wago.com/2002-423/000-005</a></p>
	<p><b>Item no.: 2002-435</b> Jumper; from 1 to 5; insulated; light gray</p>	<p><a href="http://www.wago.com/2002-435">www.wago.com/2002-435</a></p>
	<p><b>Item no.: 2002-436</b> Jumper; from 1 to 6; insulated; light gray</p>	<p><a href="http://www.wago.com/2002-436">www.wago.com/2002-436</a></p>
	<p><b>Item no.: 2002-437</b> Jumper; from 1 to 7; insulated; light gray</p>	<p><a href="http://www.wago.com/2002-437">www.wago.com/2002-437</a></p>
	<p><b>Item no.: 2002-438</b> Jumper; from 1 to 8; insulated; light gray</p>	<p><a href="http://www.wago.com/2002-438">www.wago.com/2002-438</a></p>
	<p><b>Item no.: 2002-439</b> Jumper; from 1 to 9; insulated; light gray</p>	<p><a href="http://www.wago.com/2002-439">www.wago.com/2002-439</a></p>
	<p><b>Item no.: 2002-440</b> Jumper; from 1 to 10; insulated; light gray</p>	<p><a href="http://www.wago.com/2002-440">www.wago.com/2002-440</a></p>
	<p><b>Item no.: 2002-472</b> Staggered jumper; 2-way; insulated; light gray</p>	<p><a href="http://www.wago.com/2002-472">www.wago.com/2002-472</a></p>
	<p><b>Item no.: 2002-473</b> Staggered jumper; 3-way; insulated; light gray</p>	<p><a href="http://www.wago.com/2002-473">www.wago.com/2002-473</a></p>
	<p><b>Item no.: 2002-475/011-000</b> Staggered jumper; 3-way; insulated; light gray</p>	<p><a href="http://www.wago.com/2002-475/011-000">www.wago.com/2002-475/011-000</a></p>
	<p><b>Item no.: 2002-475</b> Staggered jumper; 5-way; insulated; light gray</p>	<p><a href="http://www.wago.com/2002-475">www.wago.com/2002-475</a></p>
	<p><b>Item no.: 2002-476</b> Staggered jumper; 6-way; insulated; light gray</p>	<p><a href="http://www.wago.com/2002-476">www.wago.com/2002-476</a></p>
	<p><b>Item no.: 2002-474</b> Staggered jumper; 4-way; insulated; light gray</p>	<p><a href="http://www.wago.com/2002-474">www.wago.com/2002-474</a></p>
	<p><b>Item no.: 2002-477</b> Staggered jumper; 7-way; insulated; light gray</p>	<p><a href="http://www.wago.com/2002-477">www.wago.com/2002-477</a></p>
	<p><b>Item no.: 2002-473/011-000</b> Staggered jumper; 2-way; from 1 to 3; insulated; light gray</p>	<p><a href="http://www.wago.com/2002-473/011-000">www.wago.com/2002-473/011-000</a></p>
	<p><b>Item no.: 2002-479</b> Staggered jumper; 9-way; insulated; light gray</p>	<p><a href="http://www.wago.com/2002-479">www.wago.com/2002-479</a></p>

Subject to changes. Please also observe the further product documentation!

	<b>Item no.: 2002-478</b> Staggered jumper; 8-way; insulated; light gray	<a href="http://www.wago.com/2002-478">www.wago.com/2002-478</a>
	<b>Item no.: 2002-479/011-000</b> Staggered jumper; insulated; light gray	<a href="http://www.wago.com/2002-479/011-000">www.wago.com/2002-479/011-000</a>
	<b>Item no.: 2002-480</b> Staggered jumper; 10-way; insulated; light gray	<a href="http://www.wago.com/2002-480">www.wago.com/2002-480</a>
	<b>Item no.: 2002-477/011-000</b> Staggered jumper; insulated; light gray	<a href="http://www.wago.com/2002-477/011-000">www.wago.com/2002-477/011-000</a>
	<b>Item no.: 2002-481/011-000</b> Staggered jumper; insulated; light gray	<a href="http://www.wago.com/2002-481/011-000">www.wago.com/2002-481/011-000</a>
	<b>Item no.: 2002-481</b> Staggered jumper; 11-way; insulated; light gray	<a href="http://www.wago.com/2002-481">www.wago.com/2002-481</a>
	<b>Item no.: 2002-482</b> Staggered jumper; 12-way; insulated; light gray	<a href="http://www.wago.com/2002-482">www.wago.com/2002-482</a>
	<b>Item no.: 2002-424/000-006</b> Continuous jumper; from 1 to 4; insulated; blue	<a href="http://www.wago.com/2002-424/000-006">www.wago.com/2002-424/000-006</a>
<b>Tool</b>		
Operating tool		
	<b>Item no.: 210-720</b> Operating tool; Blade: 3.5 x 0.5 mm; with a partially insulated shaft; multicoloured	<a href="http://www.wago.com/210-720">www.wago.com/210-720</a>
<b>Marking accessories</b>		
Marking strip		
	<b>Item no.: 2009-110</b> Marking strips; for Smart Printer; on reel; not stretchable; plain; snap-on type; white	<a href="http://www.wago.com/2009-110">www.wago.com/2009-110</a>
Marker carrier		
	<b>Item no.: 2009-198</b> Adaptor; gray	<a href="http://www.wago.com/2009-198">www.wago.com/2009-198</a>
	<b>Item no.: 2002-161</b> Adaptor; gray	<a href="http://www.wago.com/2002-161">www.wago.com/2002-161</a>
Marker		

Subject to changes. Please also observe the further product documentation!



 **Item no.: 2009-145** [www.wago.com/2009-145](http://www.wago.com/2009-145)  
Mini-WSB Inline; for Smart Printer; 1700 pieces on roll; stretchable 5 - 5.2 mm; plain; snap-on type; white

 **Item no.: 2009-115** [www.wago.com/2009-115](http://www.wago.com/2009-115)  
WMB-Inline; for Smart Printer; 1500 pieces on roll; stretchable 5 - 5.2 mm; plain; snap-on type; white

 **Item no.: 248-501** [www.wago.com/248-501](http://www.wago.com/248-501)  
Mini-WSB marking card; as card; not stretchable; plain; snap-on type; white

 **Item no.: 793-5501** [www.wago.com/793-5501](http://www.wago.com/793-5501)  
WMB marking card; as card; for terminal block width 5 - 17.5 mm; stretchable 5 - 5.2 mm; plain; snap-on type; white

Group marker carrier

 **Item no.: 2009-193** [www.wago.com/2009-193](http://www.wago.com/2009-193)  
Group marker carrier; gray

 **Item no.: 2009-192** [www.wago.com/2009-192](http://www.wago.com/2009-192)  
Group marker carrier; gray

 **Item no.: 2009-191** [www.wago.com/2009-191](http://www.wago.com/2009-191)  
Group marker carrier; gray

Coding

Coding

 **Item no.: 2022-100** [www.wago.com/2022-100](http://www.wago.com/2022-100)  
Carrier with 6 coding pins; for coding of female plugs; orange

Push-in type wire jumper

Jumper

 **Item no.: 2009-412** [www.wago.com/2009-412](http://www.wago.com/2009-412)  
Push-in type wire jumper; insulated; 60 mm long; black

 **Item no.: 2009-414** [www.wago.com/2009-414](http://www.wago.com/2009-414)  
Push-in type wire jumper; 1.5 mm<sup>2</sup>; insulated; 110 mm long; black

 **Item no.: 2009-416** [www.wago.com/2009-416](http://www.wago.com/2009-416)  
Push-in type wire jumper; 1.5 mm<sup>2</sup>; insulated; 250 mm long; black

 **Item no.: 2009-414/000-005** [www.wago.com/2009-414/000-005](http://www.wago.com/2009-414/000-005)  
Push-in type wire jumper; 1.5 mm<sup>2</sup>; insulated; 110 mm long; black

 **Item no.: 2009-414/000-006** [www.wago.com/2009-414/000-006](http://www.wago.com/2009-414/000-006)  
Push-in type wire jumper; insulated; 110 mm long; black

Subject to changes. Please also observe the further product documentation!

## Downloads Documentation

### Bid Text

2022-1807 docx - Datei	2019 May 20	docx 15.4 kB	Download
---------------------------	-------------	-----------------	----------

2022-1807 X81 - Datei	2019 May 20	xml 4.2 kB	Download
--------------------------	-------------	---------------	----------

### Additional Information

Technical Section Technical explanations		pdf 2.2 MB	Download
---	--	---------------	----------

## Environmental Product Compliance

### Compliance Search

Environmental Product Compliance 2022-1807 4-pin ground carrier terminal block; for DIN-rail 35 x 15 and 35 x 7.5; green-yellow		URL	Download
--	--	-----	----------

## Installation Notes

### Installation

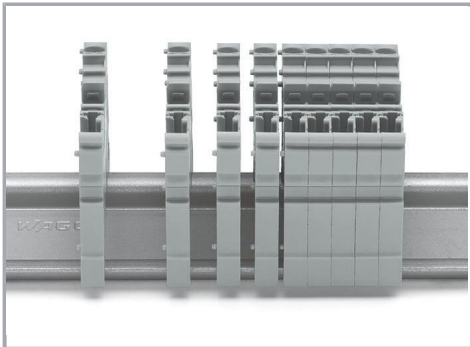

Snap individual carrier terminal blocks onto the DIN-rail and slide together.

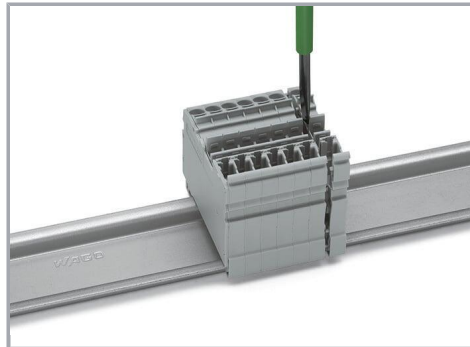

Open the assembly by laterally sliding a block via operating tool (3.5 x 0.5 mm blade).

Subject to changes. Please also observe the further product documentation!

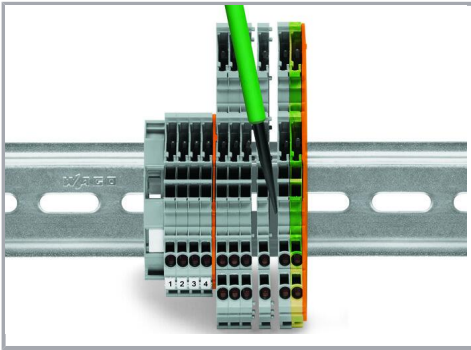

Separate terminal block assembly and slide individual terminal blocks laterally using an operating tool.

### Commoning

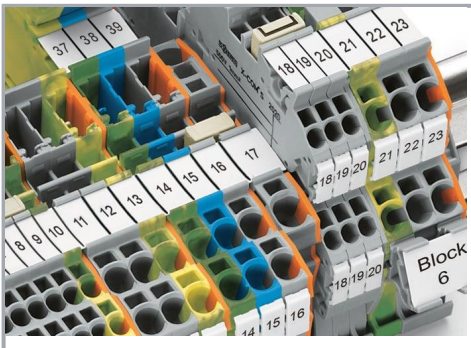

Commoning X-COM®S-SYSTEM Terminal Blocks using jumpers for TOPJOB® S Terminal Blocks. An end plate provides connection to TOPJOB® S Terminal Blocks. 2020 and 2022 Series Terminal Blocks are combinable. Jumper slots are on the same level for both series.

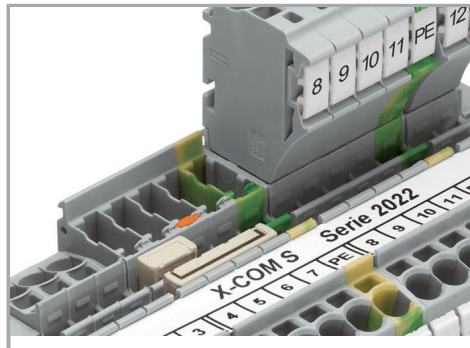

Pairing push-in comb style jumpers.

Subject to changes. Please also observe the further product documentation!

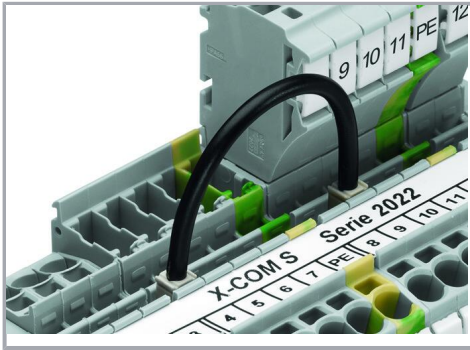

Commoning with push-in type wire jumper.

### Testing

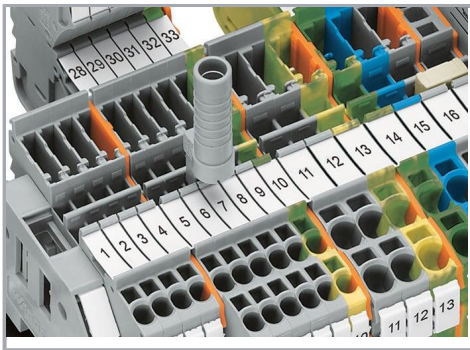

Test plug adapter (2009-174) for 4 mm test plugs or banana plugs – also suitable for X-COM®S-SYSTEM-MINI Terminal Blocks.

### Coding

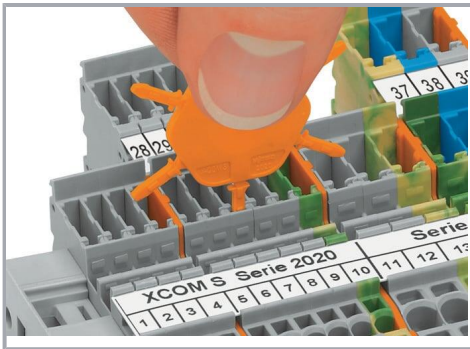

Insert coding pin into the corresponding slot and twist it off.

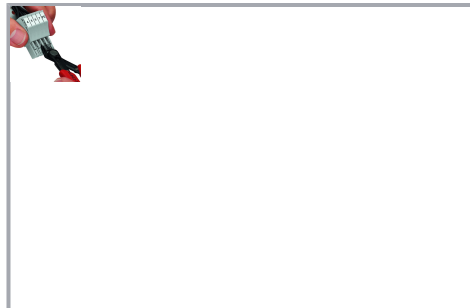

Coding a female plug: remove coding finger using a suitable tool.

Subject to changes. Please also observe the further product documentation!



Insert a coding pin (2022-100) into the corresponding location of the carrier terminal block.

### Marking

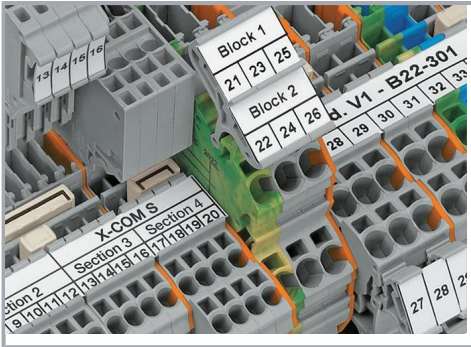

Clear marking via large marking area

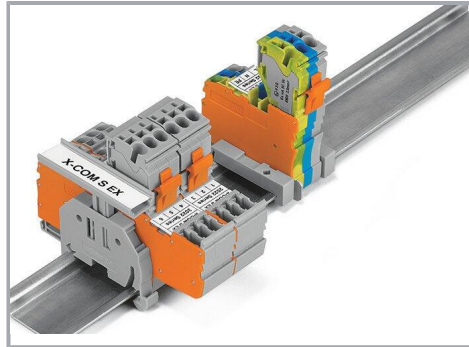

Group marking with height-adjustable group marker carrier (2009-163)

### Security

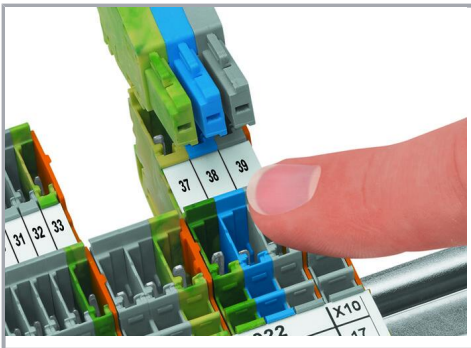

Carrier terminal blocks and female plugs are touch-proof.

### Product family

Subject to changes. Please also observe the further product documentation!



**X-COM S**

[Show all products from the family](#)

Subject to changes. Please also observe the further product documentation!

---

WAGO GmbH & Co. KG

Hansastr. 27

32423 Minden

Phone: +49571 887-0 | Fax: +49571 887-169

Email: [info.de@wago.com](mailto:info.de@wago.com) | Web: [www.wago.com](http://www.wago.com)

Do you have any questions about our products?

We are always happy to take your call at +49 (571) 887-44222.