

ERO610T222MUAL

Aliases (C822UA222M440X, ERO610RJ4220MUAL)

Obsolete

ERO610 SFTY X1-440 Y2-250, Ceramic, 2200 pF, 20%, 440 VAC (X1), 250 VAC (Y2), Y5U, Lead Spacing = 5mm

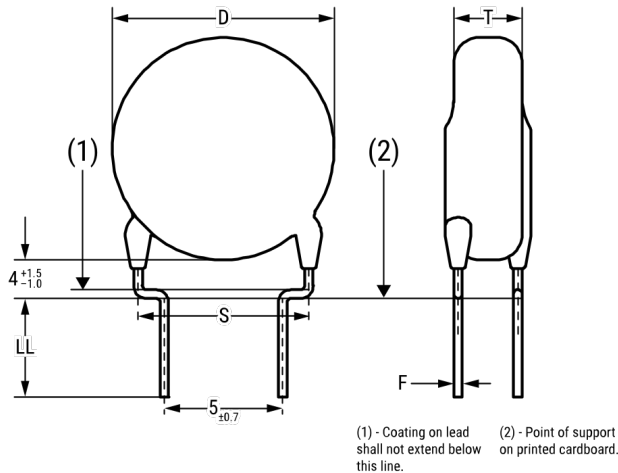

Click [here](#) for the 3D model.

Dimensions

D	9mm MAX
T	4.5mm MAX
S	5mm +/-0.7mm
H0	16mm +/-0.5mm
F	0.6mm +/-0.05mm
V	1.4mm +/-0.5mm

Packaging Specifications

Packaging Ammo, H0 = 16mm, Component Pitch = 12.7mm

General Information

Series	ERO610 SFTY X1-440 Y2-250
Style	Radial Disc
Description	Ceramic Single Layer Safety Disc Capacitors
RoHS	Yes
Termination	Tin
Qualifications	UL, CSA, CAN, ENEC, VDE
AEC-Q200	No
Notes	Please See Bulletin For Taping Information. H0 Dimension Refers to Seating Plane To Center Hole of Tape.

Specifications

Capacitance	2200 pF
Capacitance Tolerance	20%
Voltage AC	440 VAC (X1), 250 VAC (Y2)
Temperature Range	-40/+125°C
Temperature Coefficient	Y5U
Dissipation Factor	2.5%
Insulation Resistance	6 GOhms
Safety Class	X1/Y2