



LED Area Light

Bear Series



Bear Series

Beyond LED Technology's Newest Bear Series Area light is the most unique and revolutionary product of 2021. It's the worlds first Wattage and CCT Adjustable Area light. Our 300 Watt light's Wattage can be adjusted to 200 Watts and 240 Watts. Our 150 Watt light's Wattage can be adjusted to 120 Watts and 100 Watts. Also our Bear Series offers CCT adjustment to 4000K, 5000K, and 5700K. Our Bear Series Area Lights have a new heat sink design that ensures that the light stays cool and extends its life.

- High Efficiency BridgeLux Chips
- Ultra thin sleek design
- Up to 135 lumens per watt
- Optional 3 pin Screw-in photocell
- Built-in 10KV Surge protector
- Several bracket options
- Heat resistant polycarbonate optical lens
- Die Cast Aluminum housing
- Available in Black Housing
- IP65 Rated
- Universal 100-277Vac / 480Vac optional
- UL & DLC Approved

LED Area Light Bear Series

SKU #	Model #	Housing	Watts	Lumens	CCT	IP	Input Voltage	Certifications
151630	BLT-S-GB-150W	Black	150W Adjustable Wattage 120W/100W	21750Lm	5700K Adjustable CCT 4K/5K	IP65	120-277Vac	UL, DLC
151631	BLT-S-GB-300W	Black	300W Adjustable Wattage 240W/200W	43500Lm	5700K Adjustable CCT 4K/5K	IP65	120-277Vac	UL, DLC

Specifications

Input Power (Tolerance : ±10%)	150W			300W		
	Color Temperature	4000K	5000K	5700K	4000K	5000K
Lumen (Tolerance : -10%)	20000LM	22000LM	20000LM	40000LM	43500LM	40000LM
Efficacy (Tolerance : -3%)	135LM/W	146LM/W	135LM/W	135LM/W	145LM/W	135LM/W
CRI	>70			>70		
Color Consistency	<7 Steps (or <7 SDCM)			<7 Steps (or <7 SDCM)		
BUG	B3-U0-G3			B3-U0-G3		
Distribution Pattern	Type III			Type III		
Beam Angle (50%) (Tolerance : ±15%)	140 X 100°			140 X 100°		



**Optional Photocell
SKU #151636**

Color tunable instruction:

1. The color temperature of the lamp turns to 4000K when the switch is set to 4000K
 2. The color temperature of the lamp turns to 5000K when the switch is set to 5000K
 3. The color temperature of the lamp turns to 5700K when the switch is set to 5700K
- Note: Please turn off the power before adjusting the color temperature.

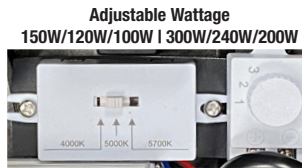

Wattage adjustable instruction:
Turn the wattage adjustable knob to a certain wattage gear, and the power of the lamp will change to the corresponding wattage. (Adjustable wattage range 66%-100%)
Note: Please turn off the power before adjusting the wattage.

ELECTRICAL	Input Voltage and Frequency	120-277Vac 50/60Hz
	PF (Tolerance : -3%)	≥0.9
	THD (Tolerance : +5%)	≤20%
	Flicker Percent	<5%
	Driver Brand	Sosen
	Driver Model	150W: SS-150VA-56B 300W: SS-320VP-56BH
	Driver Surge protection	L/N-PE: 10kV, L-N: 6kV
MATERIALS	Dimming	150W: 1-10V Dimming 300W: 0-10V Dimming
	Optional Accessory	Motion Sensor, PIR sensor
	LED Brand	Bridgelux
	LED Type	SMD3030
	LED QTY	150W: 308 PCS 300W: 616PCS
	Housing	Die-cast aluminum
	Housing Color	Black
OTHERS	EPA	150W: 1.62ft² 300W: 2.15 ft²
	Waterproof Rating	WET (IP65)
	Operating Temperature	Without Motion Sensor: -40°F to 113°F; With Motion Sensor: -31°F to 113°F
	Storage Temperature	-40°F to 176°F
	Operating Humidity	20% - 90% RH
	Storage Humidity	10% - 95% RH
Warranty	5 years warranty with 24/7 operating hours Luminaire lifetime at 77°F.	

CORRELATED COLOR TEMPERATURE (CCT)

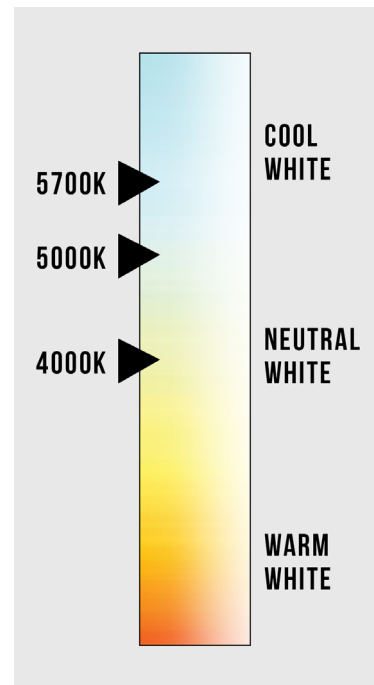

Mounting Options



**Slip Fitter
SKU #151632**



**Straight Arm
SKU #151633**



**Yoke Mount
SKU #151634**

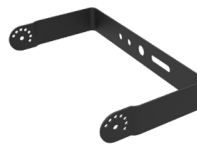

**Optional
U-Bracket Mount**

LED Area Light

Bear Series

150W Distribution Diagram

Luminaire Property

Luminaire Manufacturer:
 Luminaire Category:
 Lamp Catalog:
 Number of Lamps:
 Luminous Length (mm):
 Luminous Height (mm):
 Current: 1.273 A
 Power Factor: 0.998

Luminaire Description:
 Lamp Description:
 Lumens per Lamp:
 Luminous Width (mm):
 Voltage: 120.0 V
 Power: 152.85 W

Photometric Results

IES Classification: Type III
 Total Rated Lamp Lumens: 20283.7 lm
 Efficiency: 100%
 Upward Ratio: 0%
 C0r0 Intensity: 5148.45 cd
 Pos of Max. Intensity: H22.5 V73

Longitudinal Classification: Medium
 Measurement Flux: 20283.7 lm
 Downward Ratio: 100%
 Luminaire Efficacy Rating (LER): 132.75
 Max. Intensity: 7228.9 cd

Illuminance at a Distance

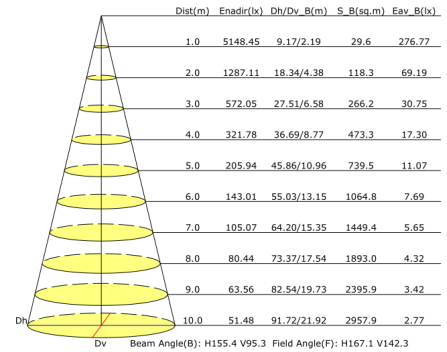

Luminous Intensity Distribution Curve

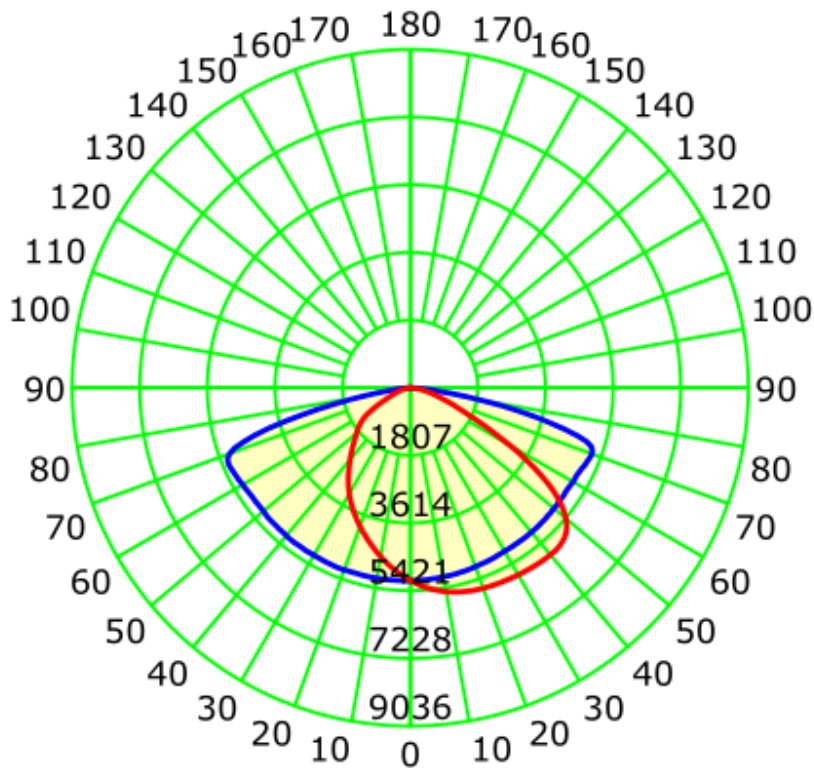

Average Diffuse Angle(50%): 125.3°

— C0-C180 — C90-C270

LED Area Light Bear Series

300W Distribution Diagram

Luminaire Property

Luminaire Manufacturer:
Luminaire Category:
Lamp Catalog:
Number of Lamps:
Luminous Length (mm):
Luminous Height (mm):
Current: 2.559 A
Power Factor: 0.998

Luminaire Description:
Lamp Description:
Lumens per Lamp:
Luminous Width (mm):
Voltage: 120.0 V
Power: 307.41 W

Photometric Results

IES Classification: Type III
Total Rated Lamp Lumens: 41311.6 lm
Efficiency: 100%
Upward Ratio: 0%
C0r0 Intensity: 10371.84 cd
Pos of Max. Intensity: H22.5 V74

Longitudinal Classification: Medium
Measurement Flux: 41311.6 lm
Downward Ratio: 100%
Luminaire Efficacy Rating (LER): 134.44
Max. Intensity: 14774.93 cd

Illuminance at a Distance

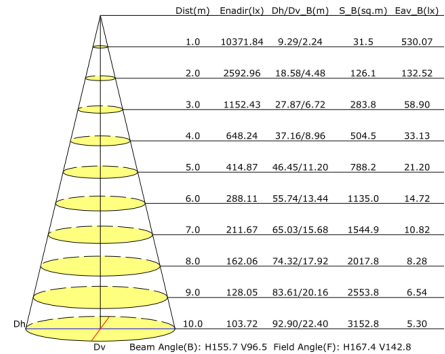

Luminous Intensity Distribution Curve

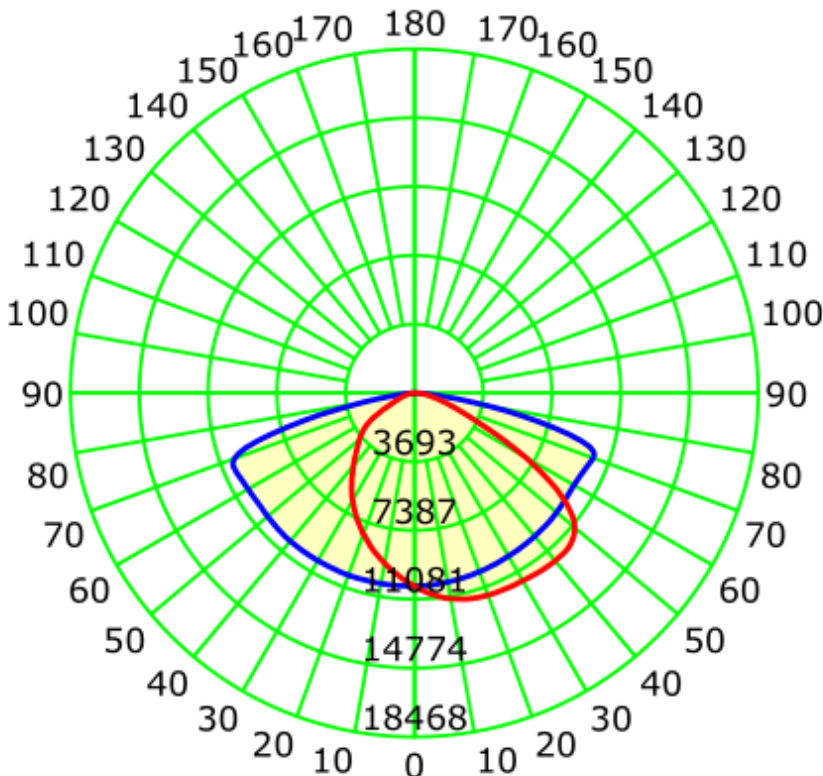

Unit: cd

Average Diffuse Angle(50%): 126.1°

— C0-C180 — C90-C270

(866) 786-1117 • www.BeyondLEDTechnology.com

Due to continuous product improvement, information in this document is subject to change.

LED Area Light

Bear Series

Mounting Options

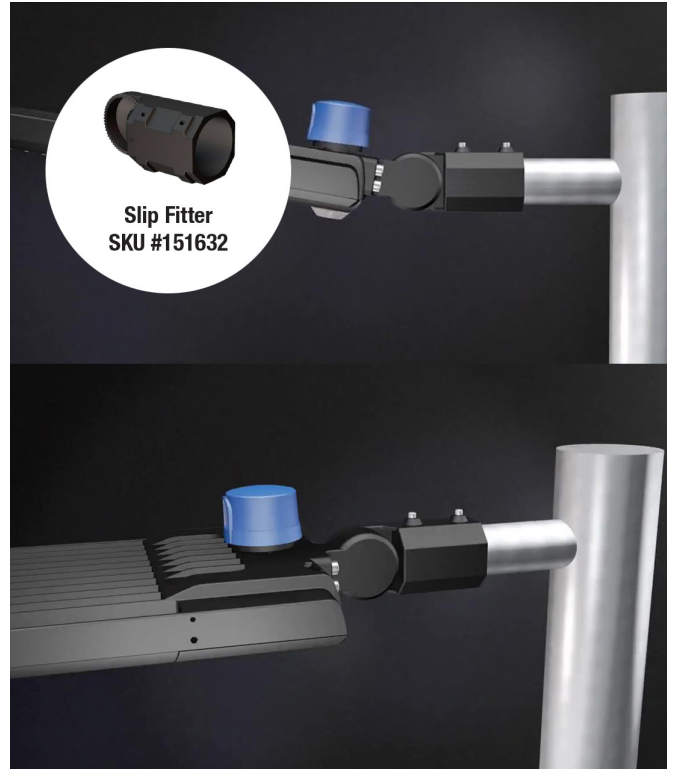

LED Area Light

Bear Series

Optional Photocell or Motion Sensor

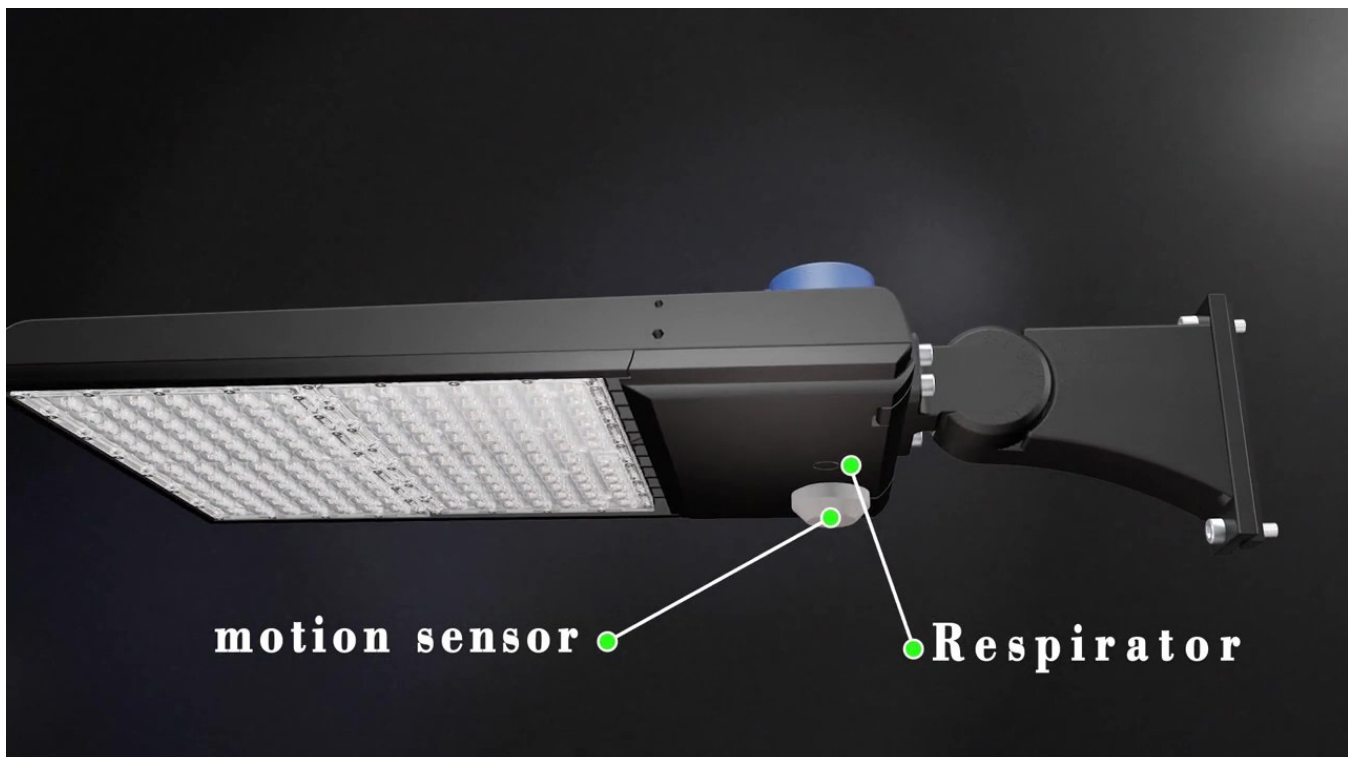
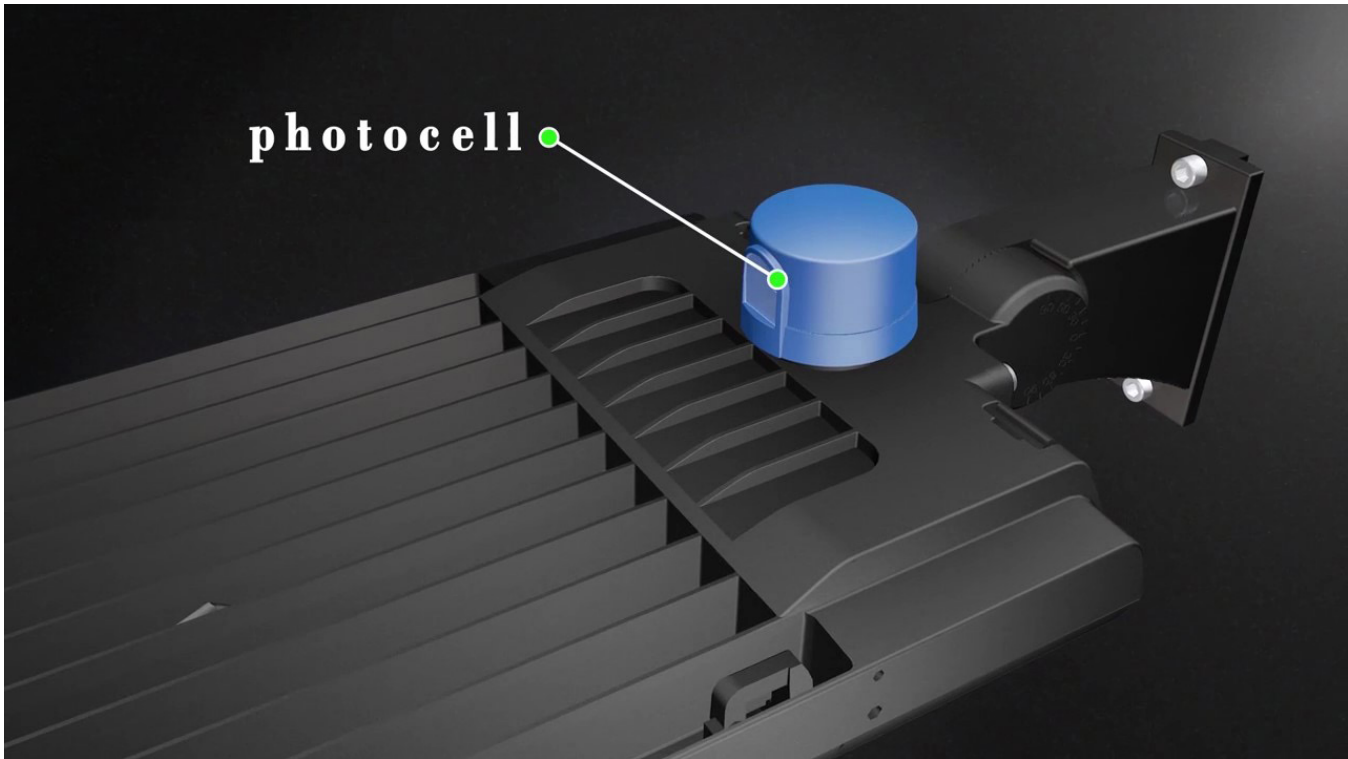

LED Area Light

Bear Series

Dimensions



150W



300W



Slip Fitter
SKU #151632

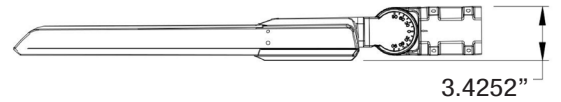
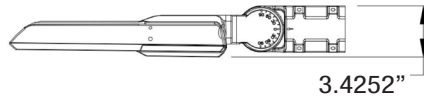
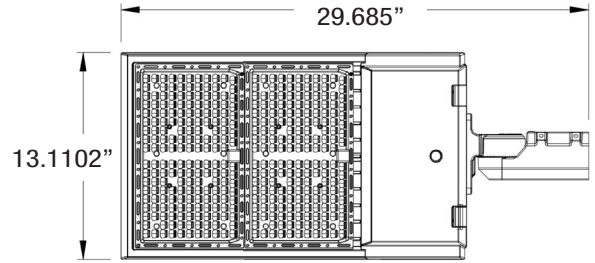
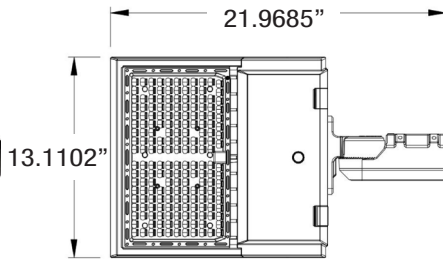

Straight Arm
SKU #151633

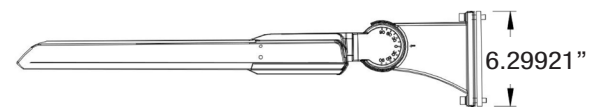
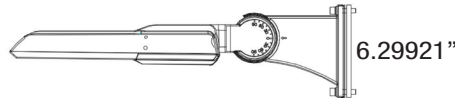
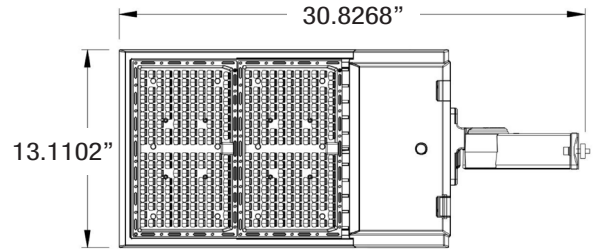
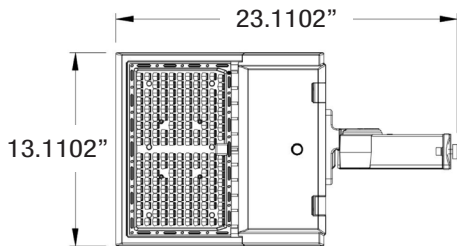

Yoke Mount
SKU #151634

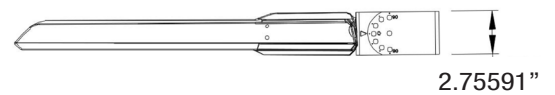
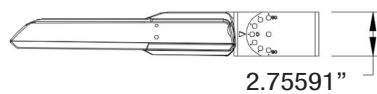
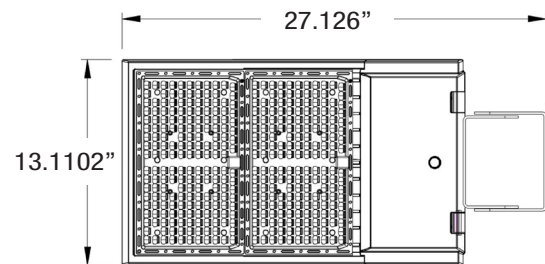
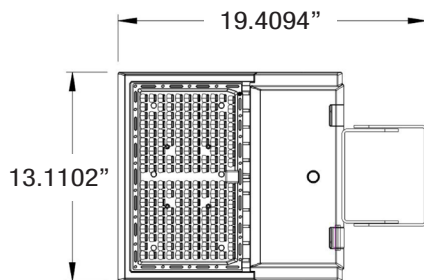

LED Area Light Bear Series

Packaging

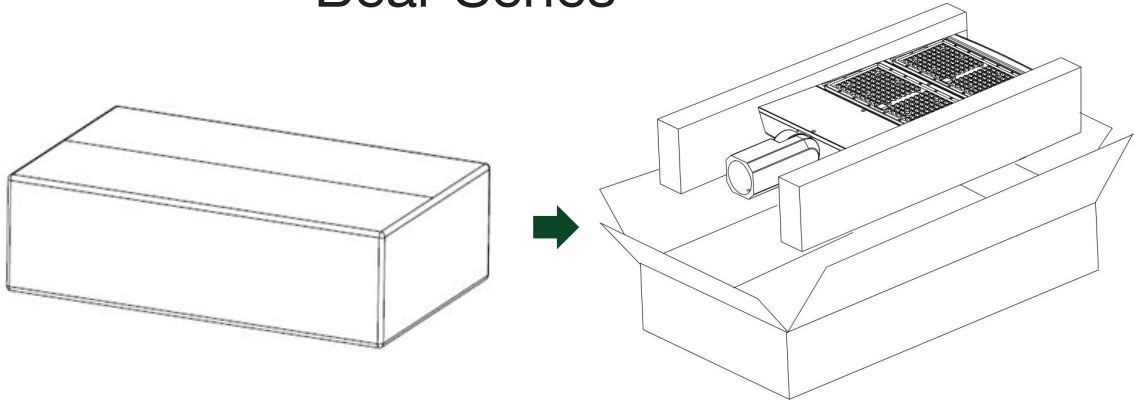

SKU #	Model #	Pcs/Box	Dimensions	Weight	Pallet Quantity	Pallet Weight	Pallet Dimensions
151630	BLT-S-GB-150W	1	20" X 16" X 7"	14 Lb			
151631	BLT-S-GB-300W	1	28" X 16" X 7"	21 Lb			
151632	Slip Fitter Mount	1	10" X 5" X 5"	6 Lb			
151633	Straight Arm Mount	1	10" X 5" X 5"	6 Lb			
151634	Yoke Mount	1	10" X 5" X 5"	4 Lb			

User Notice

- Please turn off the power before installing or changing assembly parts.
- The input voltage and lamps should be matching. Before connecting the power line, please make sure the wiring section is insulated.
- Only professionals should install and disassemble the lamps.



Trouble Shooting

- Flickering light - Turn off the power and turn on again in 3 minutes. If the same phenomena occurs, then call Support.
- Not working - Please check all power connections.