

Kontaktübersicht:  
contacts overview

L = lang / long  
M = mittel / middle  
S = kurz / short

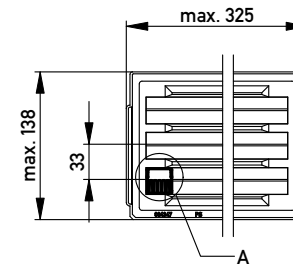
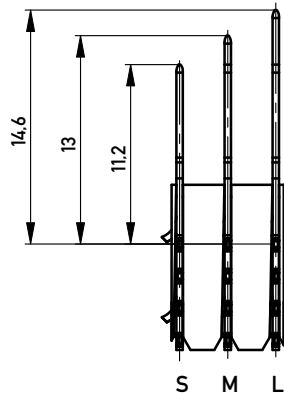

M 1:5

verpackt in Tray  
VPE: 36 St.

tray packaging  
packaging unit 36 pcs.

DETAIL A  
MAßSTAB 1:1

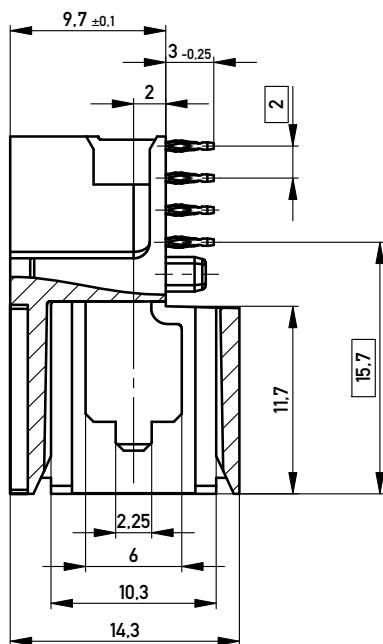
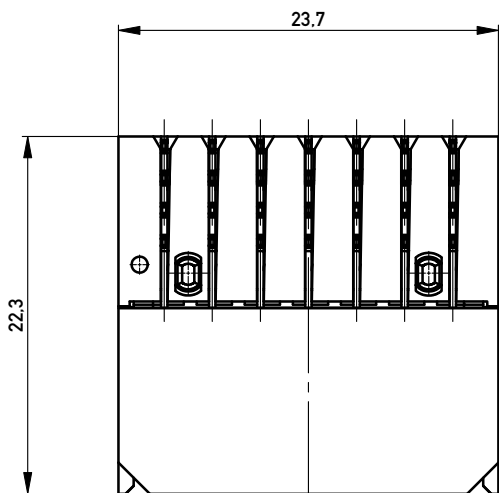
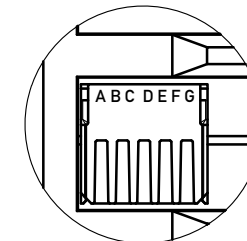

Bestückungsplan  
contact layout

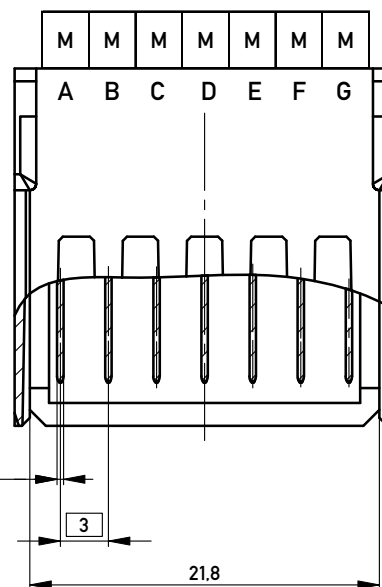

Gehäuse / housing: PBTP grau 30% GF / PBTP gray 30% GF  
Kontakte / contacts: Phosphor Bronze / phosphor bronze

Oberflächenbeschichtung / plating:  
Kontaktbereich / mating area: 2-3 µm Ni 1.2 µm Au  
Anschlussbereich / termination: 2-3 µm Ni 1 µm Sn matt

Bedruckungsvorschrift siehe Id.-Nr. 294996 /  
printingcode Id.-No. 294996

Anforderungsstufe 1  
class 1

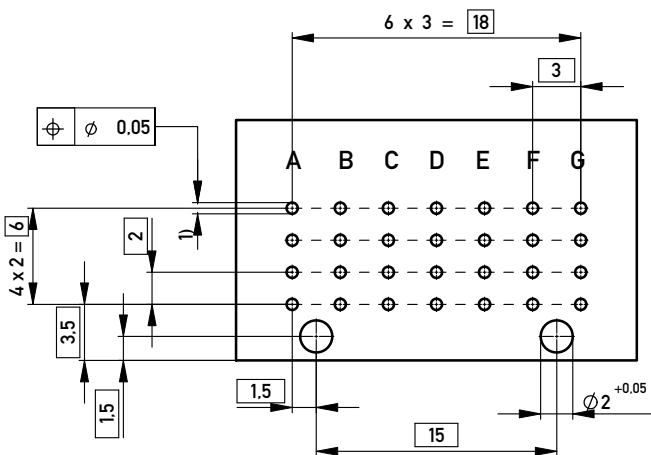

Lochbild für Leiterplatte  
Board hole pattern

- 1)  $\varnothing 0,6 \pm 0,05$  Durchmesser des metallisierten Loches  
 $\varnothing 0,6 \pm 0,05$  Diameter of finished plated-through hole

Schichtaufbau im metallisierten Loch  
siehe Zeichnung 114406  
Metal plating of plated-through hole  
see drawing 114406

Copyright by ERNI GmbH.  
Proprietary notice pursuant to ISO 16016 to be observed.

Information:		Tolerances	All Dimensions in mm	Scale	3:1
All rights reserved. Only for Information. To ensure that this is the latest version of this drawing, please contact one of the ERNI companies before using.		Subject to modification without prior notice. Drawing will not be updated.		Designation	
		www.ERNI.com		ERmet Messerl. PM 7 pol RC ERmet Male PM 7 pin RC	
-	03.09.2007			254992	
Index	Date			1 A3	
				Class ERPM	