

Data sheet | Item number: 890-665

T-distribution connector; 3-pole; Cod. A; 1 input; 2 outputs; 3 locking levers;
for flying leads; white

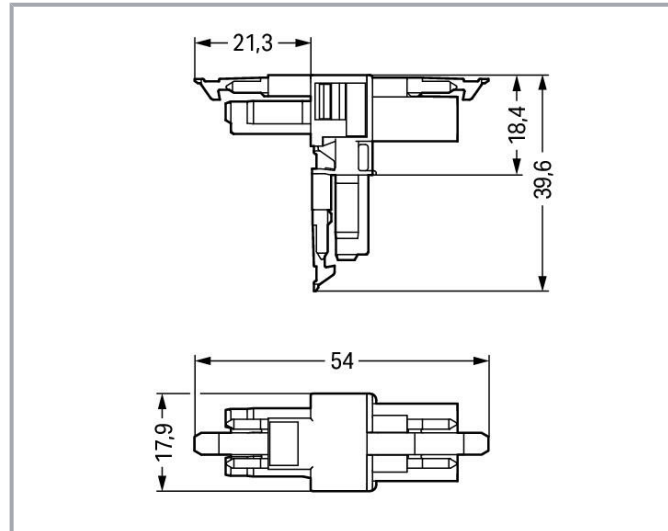

www.wago.com/890-665



Item description

Distribution connector **WINSTA®** MINI 3-pole

The **WINSTA®** MINI distribution connector with locking latch supports fast, reliable installation. Whether on PCBs, in control cabinets or for connecting lights – pluggable installation connectors from WAGO allow you to establish connections according to various requirements in seconds. The coding options reduce installation errors, allowing fast, secure wiring of all components. Thanks to the color coding and mechanical A coding of **WINSTA®** MINI pluggable installation connectors, you can clearly distinguish different circuits. Especially if only limited space is available, our smallest pluggable connection system, **WINSTA®** MINI, consistently displays its advantageous properties. It saves space, and, thanks to Push-in **CAGE CLAMP®** spring pressure connection technology, it also saves time, since the connection is low-maintenance and can be performed without screw connections.

WINSTA® MINI solutions for your electrical installation – protected against mismatching and maintenance-free

Subject to changes. Please also observe the further product documentation!

WAGO GmbH & Co. KG
Hansastr. 27
32423 Minden
Phone: +49571 887-0 | Fax: +49571 887-169
Email: info.de@wago.com | Web: www.wago.com

Do you have any questions about our products?
We are always happy to take your call at +49 (571) 887-44222.



WINSTA® is the pluggable connection system that is optimally tailored to the strict requirements of electrical installation. It ensures error-free installation of cables and components, quickly and reliably. Now you can also cut installation expenses without compromising safety and quality: The WINSTA® MINI pluggable installation connector with locking lever reduces the need for servicing and prevents unnecessary downtime.

- protection against mismatching eliminates errors
- compact design for conductors with a cross-section up to 1.5 mm²
- with A coding for use in a large number of general mains applications
- custom-engineered solutions
- quick replacement of defective units during ongoing operation

Data

Electrical data

Ratings per IEC/EN

Ratings per	IEC/EN 60664-1
Nominal voltage (III/3)	250 V
Rated impulse voltage (III/3)	4 kV
Rated current	16 A
Legend (ratings)	(III / 3) ≙ Overvoltage category III / Pollution degree 3

Ratings per UL 1977

Note for the US market	Some versions may also be used for current interruption in accordance with the UL certificate in select applications with currents below 5 A and voltages up to 600 V. For further information, please contact your local sales office.
Rated voltage (UL 1977)	600 V
Rated current UL 1977	14 A

General

Note on contact resistance	approx. 1 mΩ of contact resistance approx. 0.25 mΩ contact transition plug/socket
----------------------------	--

Connection data

Total number of potentials	3
PE function	Preceding PE contact

Subject to changes. Please also observe the further product documentation!



Connection 1

Pole number	3
-------------	---

Physical data

Pin spacing	4.4 mm / 0.173 inches
Width	17.9 mm / 0.705 inches
Height	39.6 mm / 1.559 inches
Depth	54 mm / 2.122 inches

Mechanical Data

Application	General mains applications
Coding	A
Variable coding	No
Marking	L \perp N
Potential marking	L \perp N
Mating force of a plug-in connection	approx. 20 ... 70 N (depending on pole number)
Retention force of a plug-in connection	When locked: > 80 N
Unmating force of a plug-in connection	Unlocked: approx. 20 ... 70 N (depending on pole number)
Number of mating cycles	200, without resistive load
Type of distribution box	T-distribution connector
Protection type	IP20; IP40 when mated
Suitable	for flying leads

Plug-in connection

Contact type (pluggable connector)	Socket/plug
Mismating protection	Yes
Note on mismating protection	All WINSTA [®] components are 100% protected against mismating when: a.) plugging different numbers of poles b.) plugging while rotated 180 c.) plugging while laterally staggered d.) plugging one pole
Locking lever	yes
Locking of plug-in connection	locking lever
Note on locking system	All connectors for mounted installations (snap-in versions for lighting fixtures or devices, all types of PCB and distribution connectors) are factory-equipped with locking levers to ensure

Subject to changes. Please also observe the further product documentation!



plugs and sockets are securely locked. Additional locking levers are only required for flying leads (plug/socket).

Material Data

Note (material data)

Information on material specifications can be found here

Color	white
Material group	I
Insulation material	Polyamide (PA66)
Flammability class per UL94	V0
Contact material	Copper or copper alloy; surface-treated
Contact plating	Tin
Fire load	0.209 MJ
Weight	8.6 g

Environmental requirements

Processing temperature	-5 ... +40 °C
Continuous operating temperature	-35 ... +85 °C
Note on continuous operating temperature	Insulating parts for temperatures \leq 105 °C

Commercial data

Product Group	20 (Winsta)
eCl@ss 10.0	27-44-06-03
eCl@ss 9.0	27-44-06-03
ETIM 8.0	EC002567
ETIM 7.0	EC002567
PU (SPU)	25 pcs
Packaging type	box
Country of origin	DE
GTIN	4045454490515
Customs tariff number	85366990990

Environmental Product Compliance

RoHS Compliance Status	Compliant, No Exemption
------------------------	-------------------------



Subject to changes. Please also observe the further product documentation!

WAGO GmbH & Co. KG
 Hansastr. 27
 32423 Minden
 Phone: +49571 887-0 | Fax: +49571 887-169
 Email: info.de@wago.com | Web: www.wago.com



Do you have any questions about our products?
 We are always happy to take your call at +49 (571) 887-44222.

Approvals / Certificates



General approvals

Logo	Approval	Additional Approval Text	Certificate name
	CCA DEKRA Certification B.V.	EN 61535	71- 123231
	CCA DEKRA Certification B.V.	IEC 61535	NL-85020
	cURus Underwriters Laboratories Inc.	UL 1977	E45171

Declarations of conformity and manufacturer's declarations

Logo	Approval	Additional Approval Text	Certificate name
	EU-Declaration of Conformity WAGO GmbH & Co. KG	-	-
	UK-Declaration of Conformity WAGO GmbH & Co. KG	-	-

Approvals for marine applications







Logo	Approval	Additional Approval Text	Certificate name
	ABS American Bureau of Shipping	Steel Vessel Rules	19- HG1869855- PDA
	DNV GL Det Norske Veritas, Germanischer Lloyd	-	TAE00001Z6
	LR Lloyds Register	EN 61535	08/20047 (E2)

Subject to changes. Please also observe the further product documentation!

WAGO GmbH & Co. KG
Hansastr. 27
32423 Minden
Phone: +49571 887-0 | Fax: +49571 887-169
Email: info.de@wago.com | Web: www.wago.com

Do you have any questions about our products?
We are always happy to take your call at +49 (571) 887-44222.

Counterpart

	Item no.890-123 Socket; with strain relief housing; 3-pole; Cod. A; 1,50 mm ² ; white	www.wago.com/890-123
	Item no.890-133 Plug; with strain relief housing; 3-pole; 1,50 mm ² ; white	www.wago.com/890-133
	Item no.890-223 Socket; 3-pole; Cod. A; 1,50 mm ² ; white	www.wago.com/890-223
	Item no.891-8993/005-102 pre-assembled interconnecting cable; Eca; Socket/plug; 3-pole; Cod. A; 1 m; 1,00 mm ² ; white	www.wago.com/891-8993/005-102
	Item no.890-233 Plug; 3-pole; Cod. A; 1,50 mm ² ; white	www.wago.com/890-233
	Item no.891-8993/105-102 pre-assembled connecting cable; Eca; Socket/open-ended; 3-pole; Cod. A; 1 m; 1,00 mm ² ; white	www.wago.com/891-8993/105-102
	Item no.891-8993/205-102 pre-assembled connecting cable; Eca; Plug/open-ended; 3-pole; Cod. A; 1 m; 1,00 mm ² ; white	www.wago.com/891-8993/205-102

Downloads

Documentation

Bid Text

890-665 X81 - Datei	2019 Feb 19	xml 2.9 kB	Download
890-665 doc - Datei	2018 Nov 30	doc 23.0 kB	Download

CAD/CAE-Data

CAE data

EPLAN Data Portal 890-665	URL	Download
WSCAD Universe 890-665	URL	Download

Subject to changes. Please also observe the further product documentation!

Environmental Product Compliance

Compliance Search

Environmental Product Compliance 890-665

URL

Download

T-distribution connector; 3-pole; Cod. A; 1 input; 2 outputs; 3 locking levers; for flying leads; white

Installation Notes

Installation

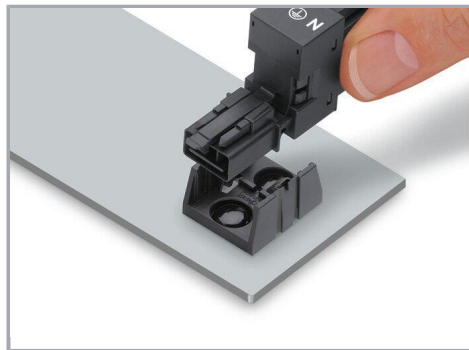

Secure the mounting plate via pins.

Product family

WINSTA® MINI

[Show all products from the family](#)

Subject to changes. Please also observe the further product documentation!