

Trench gate field-stop, 650 V, 120 A, low-loss M series IGBT in a Max247 long leads package

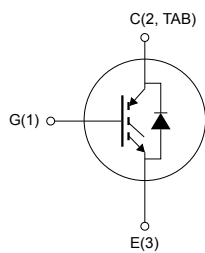

NG1E3C2T

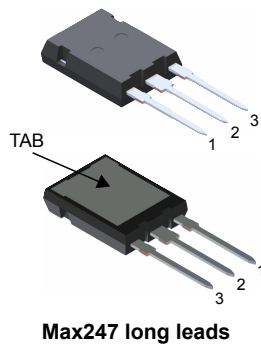

Features

- Maximum junction temperature: $T_J = 175\text{ °C}$
- 6 μs of minimum short-circuit withstand time
- $V_{CE(sat)} = 1.65\text{ V (typ.) @ } I_C = 120\text{ A}$
- Tight parameter distribution
- Safer paralleling
- Positive $V_{CE(sat)}$ temperature coefficient
- Low thermal resistance
- Soft- and fast-recovery antiparallel diode

Applications

- Motor control
- UPS
- PFC
- General purpose inverter

Description

This device is an IGBT developed using an advanced proprietary trench gate field-stop structure. The device is part of the M series IGBTs, which represent an optimal balance between inverter system performance and efficiency where the low-loss and the short-circuit functionality is essential. Furthermore, the positive $V_{CE(sat)}$ temperature coefficient and the tight parameter distribution result in safer paralleling operation.

Product status link

[STGYA120M65DF2](#)

Product summary

Order code	STGYA120M65DF2
Marking	G120M65DF2
Package	Max247 long leads
Packing	Tube

1 Electrical ratings

Table 1. Absolute maximum ratings

Symbol	Parameter	Value	Unit
V_{CES}	Collector-emitter voltage ($V_{GE} = 0\text{ V}$)	650	V
I_C	Continuous collector current at $T_C = 25\text{ °C}$	160	A
	Continuous collector current at $T_C = 100\text{ °C}$	120	
$I_{CP}^{(1)}$	Pulsed collector current	360	A
V_{GE}	Gate-emitter voltage	± 20	V
I_F	Continuous forward current at $T_C = 25\text{ °C}$	160	A
	Continuous forward current at $T_C = 100\text{ °C}$	120	
$I_{FP}^{(1)}$	Pulsed forward current	360	A
P_{TOT}	Total power dissipation at $T_C = 25\text{ °C}$	625	W
T_{STG}	Storage temperature range	-55 to 150	$^{\circ}\text{C}$
T_J	Operating junction temperature range	-55 to 175	$^{\circ}\text{C}$

1. Pulse width is limited by maximum junction temperature.

Table 2. Thermal data

Symbol	Parameter	Value	Unit
R_{thJC}	Thermal resistance, junction-to-case IGBT	0.24	$^{\circ}\text{C/W}$
	Thermal resistance, junction-to-case diode	0.6	
R_{thJA}	Thermal resistance, junction-to-ambient	50	$^{\circ}\text{C/W}$

2 Electrical characteristics

$T_J = 25\text{ °C}$ unless otherwise specified.

Table 3. Static characteristics

Symbol	Parameter	Test conditions	Min.	Typ.	Max.	Unit
$V_{(BR)CES}$	Collector-emitter breakdown voltage	$V_{GE} = 0\text{ V}$, $I_C = 250\text{ }\mu\text{A}$	650			V
$V_{CE(sat)}$	Collector-emitter saturation voltage	$V_{GE} = 15\text{ V}$, $I_C = 120\text{ A}$		1.65	2.15	V
		$V_{GE} = 15\text{ V}$, $I_C = 120\text{ A}$, $T_J = 125\text{ °C}$		1.95		
		$V_{GE} = 15\text{ V}$, $I_C = 120\text{ A}$, $T_J = 175\text{ °C}$		2.1		
V_F	Forward on-voltage	$I_F = 120\text{ A}$		1.9	2.6	V
		$I_F = 120\text{ A}$, $T_J = 125\text{ °C}$		1.7		
		$I_F = 120\text{ A}$, $T_J = 175\text{ °C}$		1.6		
$V_{GE(th)}$	Gate threshold voltage	$V_{CE} = V_{GE}$, $I_C = 2\text{ mA}$	5	6	7	V
I_{CES}	Collector cut-off current	$V_{GE} = 0\text{ V}$, $V_{CE} = 650\text{ V}$			100	μA
I_{GES}	Gate-emitter leakage current	$V_{CE} = 0\text{ V}$, $V_{GE} = \pm 20\text{ V}$			± 250	nA

Table 4. Dynamic characteristics

Symbol	Parameter	Test conditions	Min.	Typ.	Max.	Unit
C_{ies}	Input capacitance	$V_{CE} = 25\text{ V}$, $f = 1\text{ MHz}$, $V_{GE} = 0\text{ V}$	-	11	-	nF
C_{oes}	Output capacitance		-	0.61	-	nF
C_{res}	Reverse transfer capacitance		-	0.25	-	nF
Q_g	Total gate charge	$V_{CC} = 520\text{ V}$, $I_C = 120\text{ A}$, $V_{GE} = 0\text{ to }15\text{ V}$ (see Figure 30. Gate charge test circuit)	-	420	-	nC
Q_{ge}	Gate-emitter charge		-	90	-	nC
Q_{gc}	Gate-collector charge		-	160	-	nC

Table 5. IGBT switching characteristics (inductive load)

Symbol	Parameter	Test conditions	Min.	Typ.	Max.	Unit
$t_{d(on)}$	Turn-on delay time	$V_{CE} = 400\text{ V}$, $I_C = 120\text{ A}$, $V_{GE} = 15\text{ V}$, $R_G = 4.7\ \Omega$ (see Figure 29. Test circuit for inductive load switching)		66	-	ns
t_r	Current rise time			38	-	ns
$(di/dt)_{on}$	Turn-on current slope			2500	-	A/ μs
$t_{d(off)}$	Turn-off delay time			185	-	ns
t_f	Current fall time			85	-	ns
$E_{on}^{(1)}$	Turn-on switching energy			1.8	-	mJ
$E_{off}^{(2)}$	Turn-off switching energy			4.41	-	mJ
E_{ts}	Total switching energy			6.21	-	mJ
$t_{d(on)}$	Turn-on delay time	$V_{CE} = 400\text{ V}$, $I_C = 120\text{ A}$, $V_{GE} = 15\text{ V}$, $R_G = 4.7\ \Omega$, $T_J = 175\text{ }^\circ\text{C}$ (see Figure 29. Test circuit for inductive load switching)		62	-	ns
t_r	Current rise time			48	-	ns
$(di/dt)_{on}$	Turn-on current slope			2016	-	A/ μs
$t_{d(off)}$	Turn-off delay time			187	-	ns
t_f	Current fall time			164	-	ns
$E_{on}^{(1)}$	Turn-on switching energy			4.4	-	mJ
$E_{off}^{(2)}$	Turn-off switching energy			6.0	-	mJ
E_{ts}	Total switching energy			10.4	-	mJ
t_{sc}	Short-circuit withstand time	$V_{CC} \leq 400\text{ V}$, $V_{GE} = 13\text{ V}$, $T_{Jstart} \leq 150\text{ }^\circ\text{C}$	10		-	μs
		$V_{CC} \leq 400\text{ V}$, $V_{GE} = 15\text{ V}$, $T_{Jstart} \leq 150\text{ }^\circ\text{C}$	6		-	

1. Including the reverse recovery of the diode.
2. Including the tail of the collector current.

Table 6. Diode switching characteristics (inductive load)

Symbol	Parameter	Test conditions	Min.	Typ.	Max.	Unit	
t_{rr}	Reverse recovery time	$I_F = 120\text{ A}$, $V_R = 400\text{ V}$, $V_{GE} = 15\text{ V}$, $di/dt = 1000\text{ A}/\mu\text{s}$ (see Figure 29. Test circuit for inductive load switching)	-	202	-	ns	
Q_{rr}	Reverse recovery charge			-	2.9	-	μC
I_{rrm}	Reverse recovery current			-	32.5	-	A
dI_{rr}/dt	Peak rate of fall of reverse recovery current during t_b			-	500	-	A/ μs
E_{rr}	Reverse recovery energy			-	500	-	μJ
t_{rr}	Reverse recovery time		$I_F = 120\text{ A}$, $V_R = 400\text{ V}$, $V_{GE} = 15\text{ V}$, $di/dt = 1000\text{ A}/\mu\text{s}$, $T_J = 175\text{ }^\circ\text{C}$ (see Figure 29. Test circuit for inductive load switching)	-	320	-	ns
Q_{rr}	Reverse recovery charge			-	11.2	-	μC
I_{rrm}	Reverse recovery current			-	62	-	A
dI_{rr}/dt	Peak rate of fall of reverse recovery current during t_b			-	270	-	A/ μs
E_{rr}	Reverse recovery energy			-	1710	-	μJ

2.1 Electrical characteristics (curves)

Figure 1. Total power dissipation vs temperature

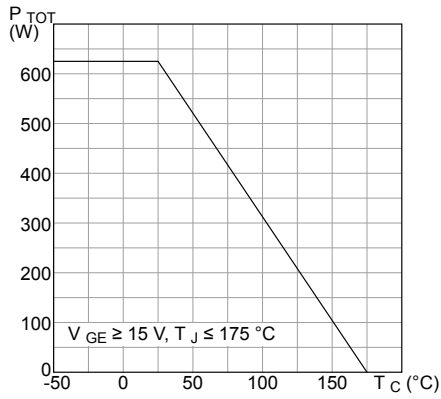

Figure 2. Collector current vs temperature

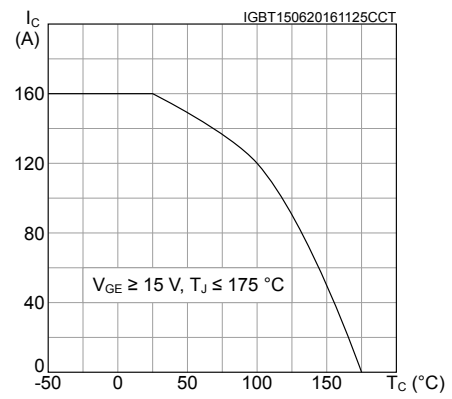

Figure 3. Typical output characteristics (T_J = 25 °C)

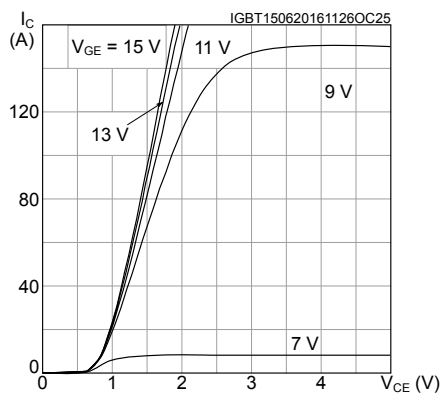

Figure 4. Typical output characteristics (T_J = 175 °C)

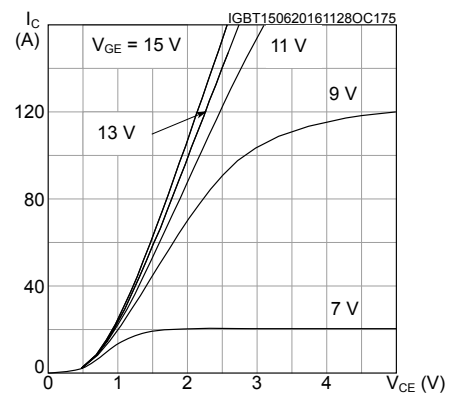

Figure 5. Typical V_{CE(sat)} vs temperature

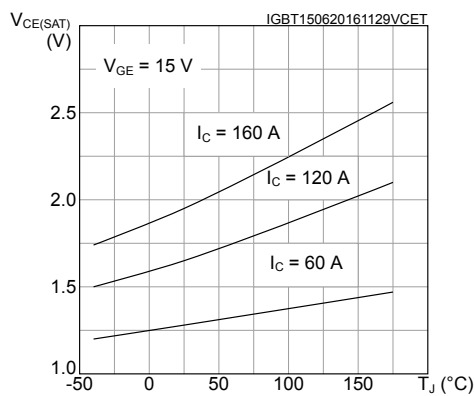

Figure 6. Typical V_{CE(sat)} vs collector current

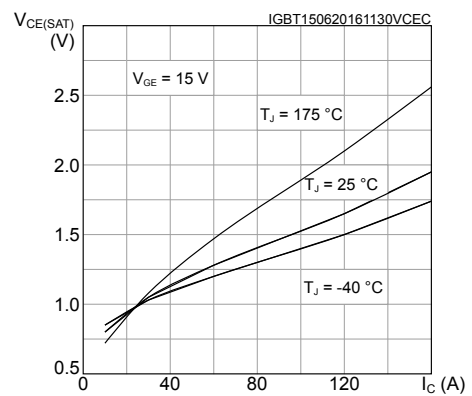

Figure 7. Collector current vs switching frequency

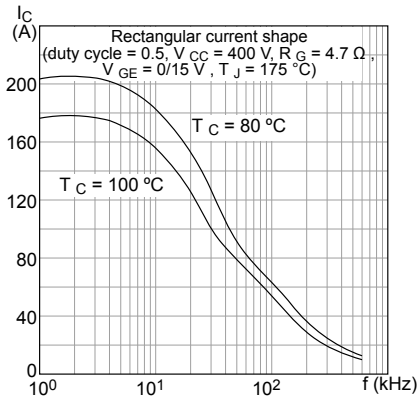

Figure 8. Forward bias safe operating area

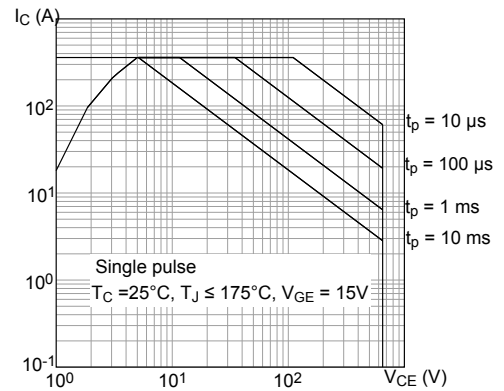

Figure 9. Typical transfer characteristics

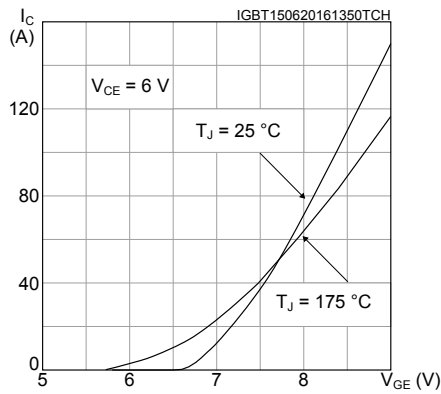

Figure 10. Typical diode Vf vs forward current

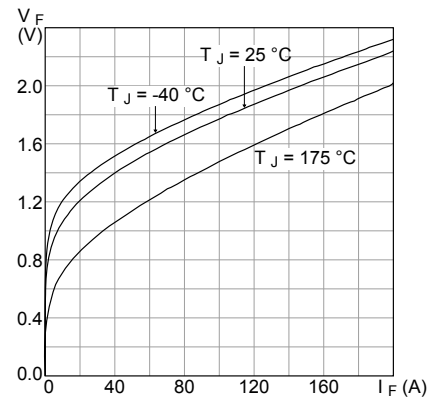

Figure 11. Normalized $V_{GE(th)}$ vs temperature

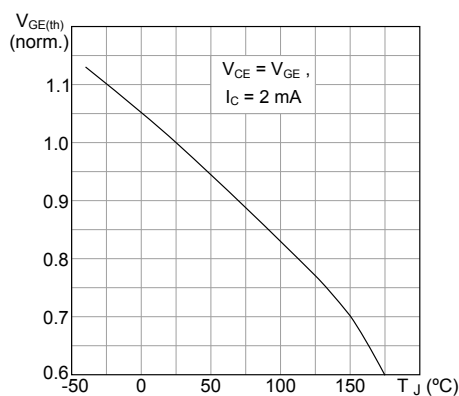

Figure 12. Normalized $V_{(BR)CES}$ vs temperature

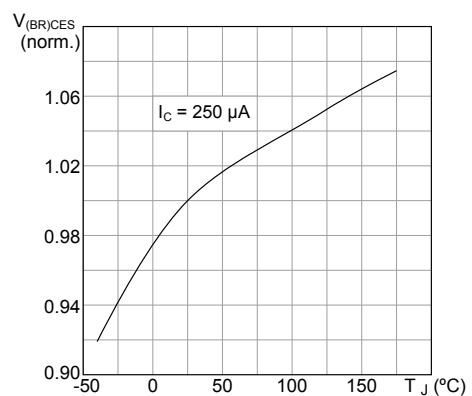

Figure 13. Typical capacitance characteristics

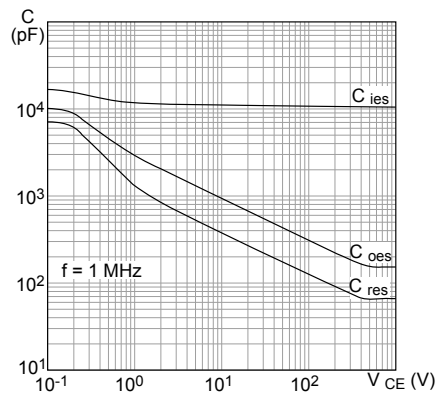

Figure 14. Typical gate charge characteristics

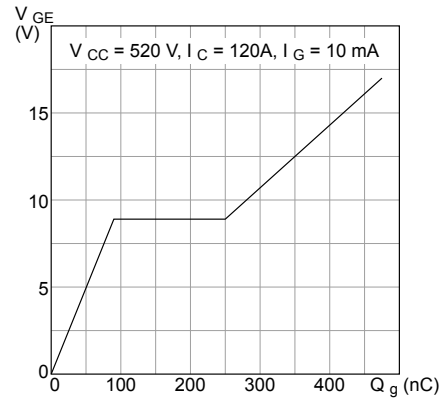

Figure 15. Typical switching energy vs collector current

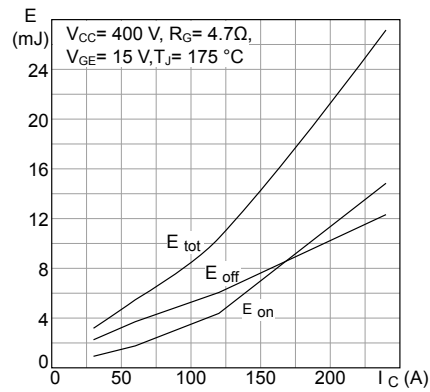

Figure 16. Typical switching energy vs R_G

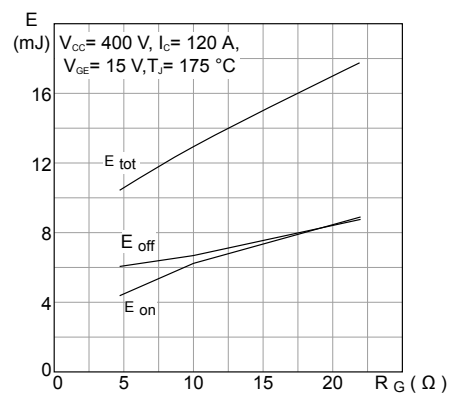

Figure 17. Typical switching energy vs temperature

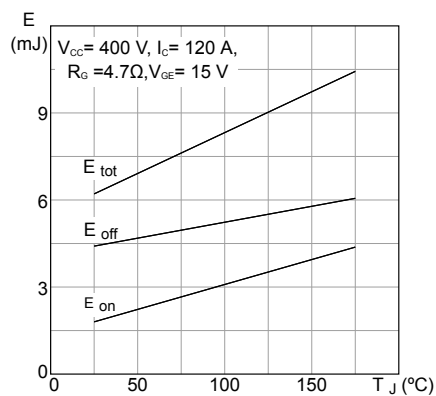

Figure 18. Typical switching energy vs collector emitter voltage

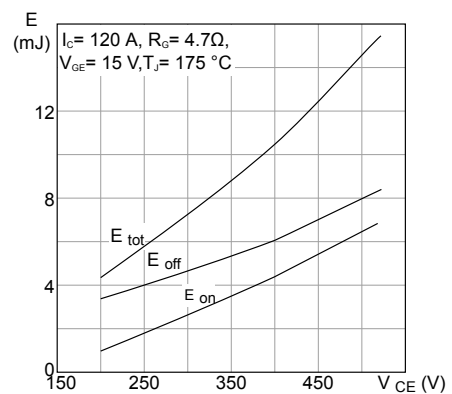

Figure 19. Short circuit time and current vs. V_{GE}

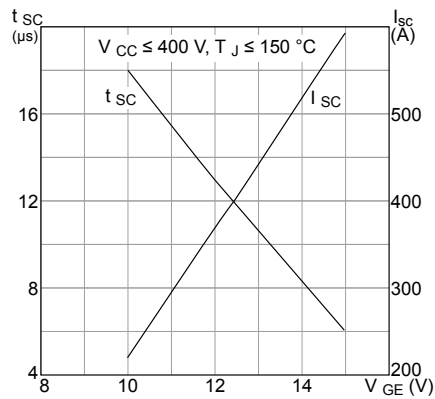

Figure 20. Typical switching times vs collector current

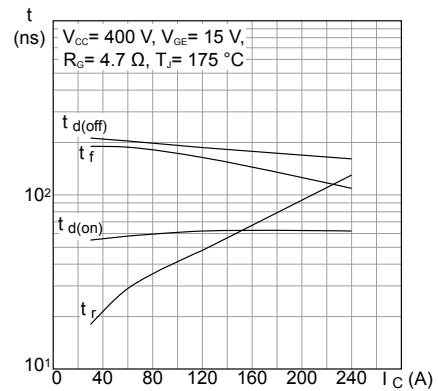

Figure 21. Typical switching times vs gate resistance

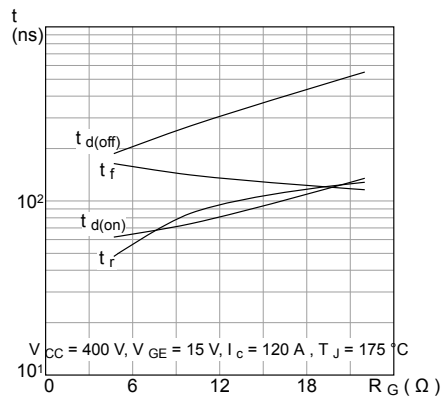

Figure 22. Typical reverse recovery current vs diode current slope

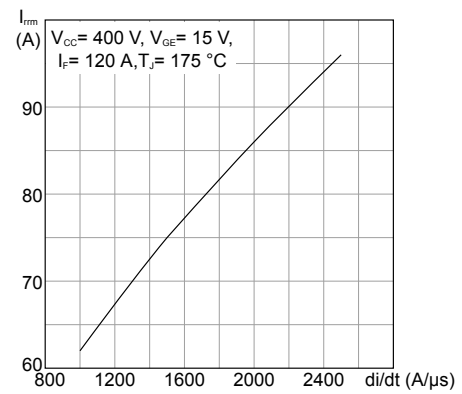

Figure 23. Typical reverse recovery time vs. diode current slope

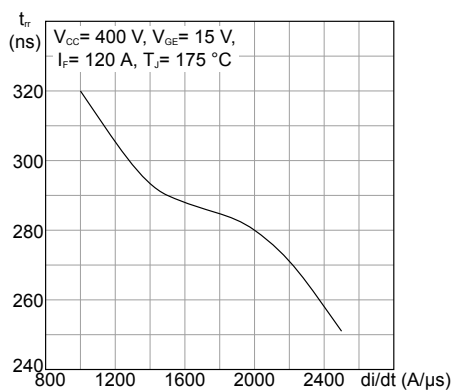

Figure 24. Typical reverse recovery charge vs diode current slope

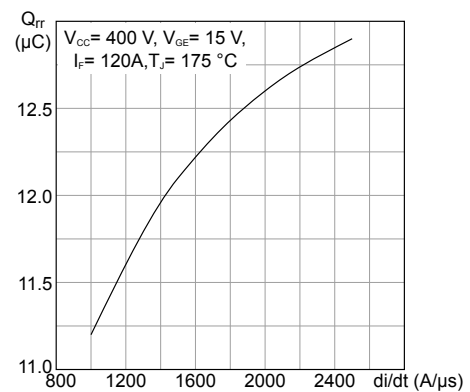

Figure 25. Typical reverse recovery energy vs diode current slope

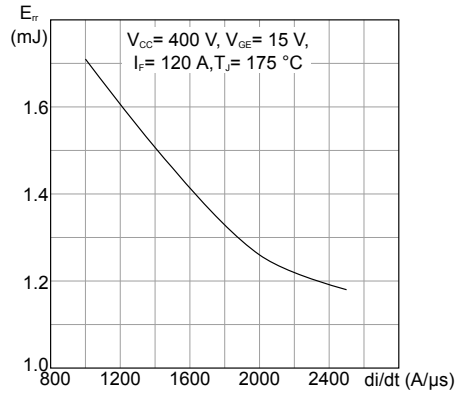

Figure 26. Normalized transient thermal impedance for IGBT

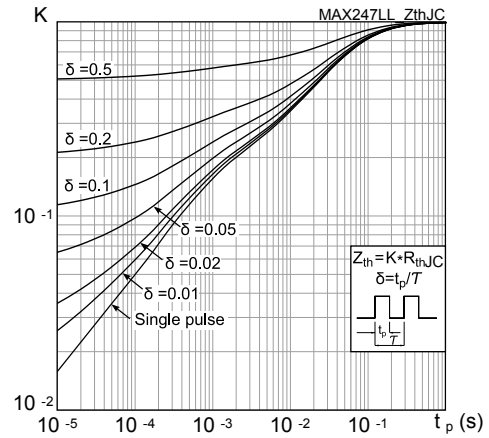
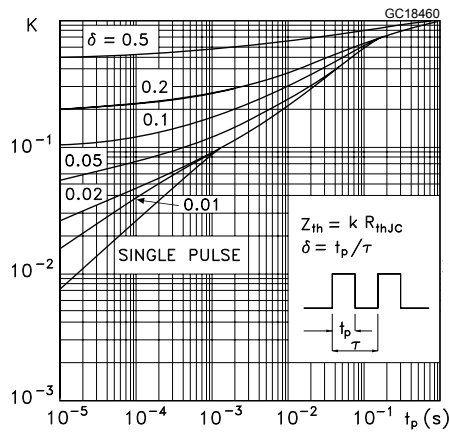
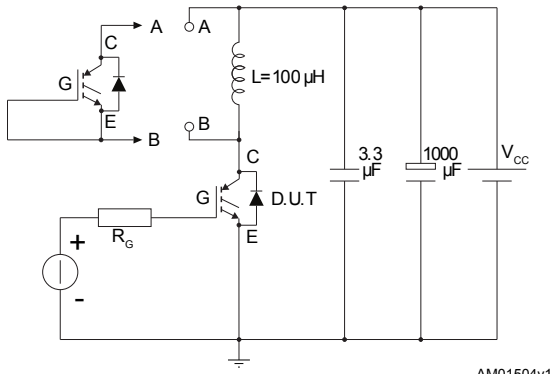
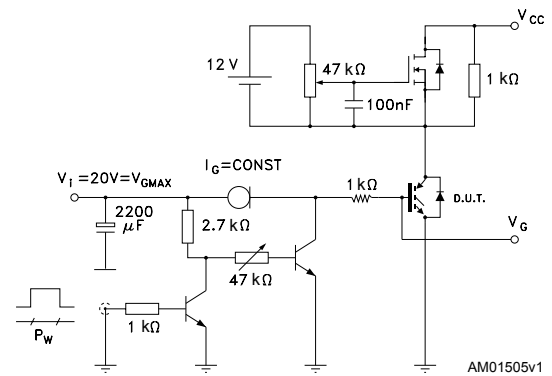
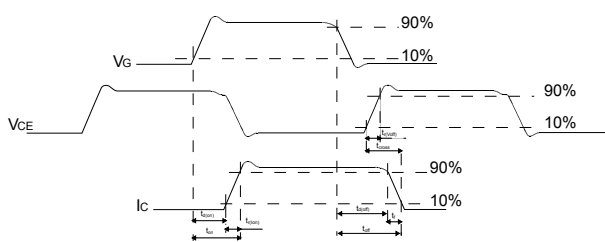
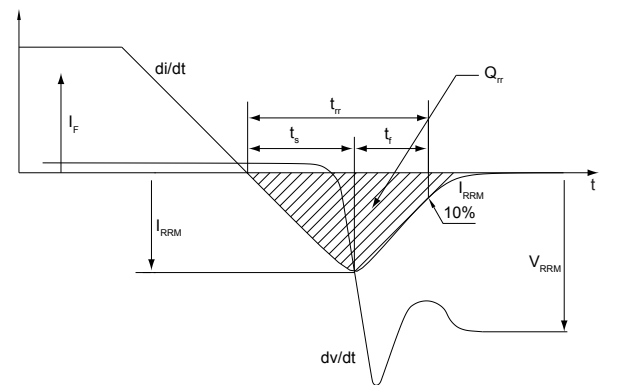

Figure 27. Normalized transient thermal impedance for diode



3 Test circuits

Figure 28. Test circuit for inductive load switching

Figure 29. Gate charge test circuit

Figure 30. Switching waveform

Figure 31. Diode reverse recovery waveform

4 Package information

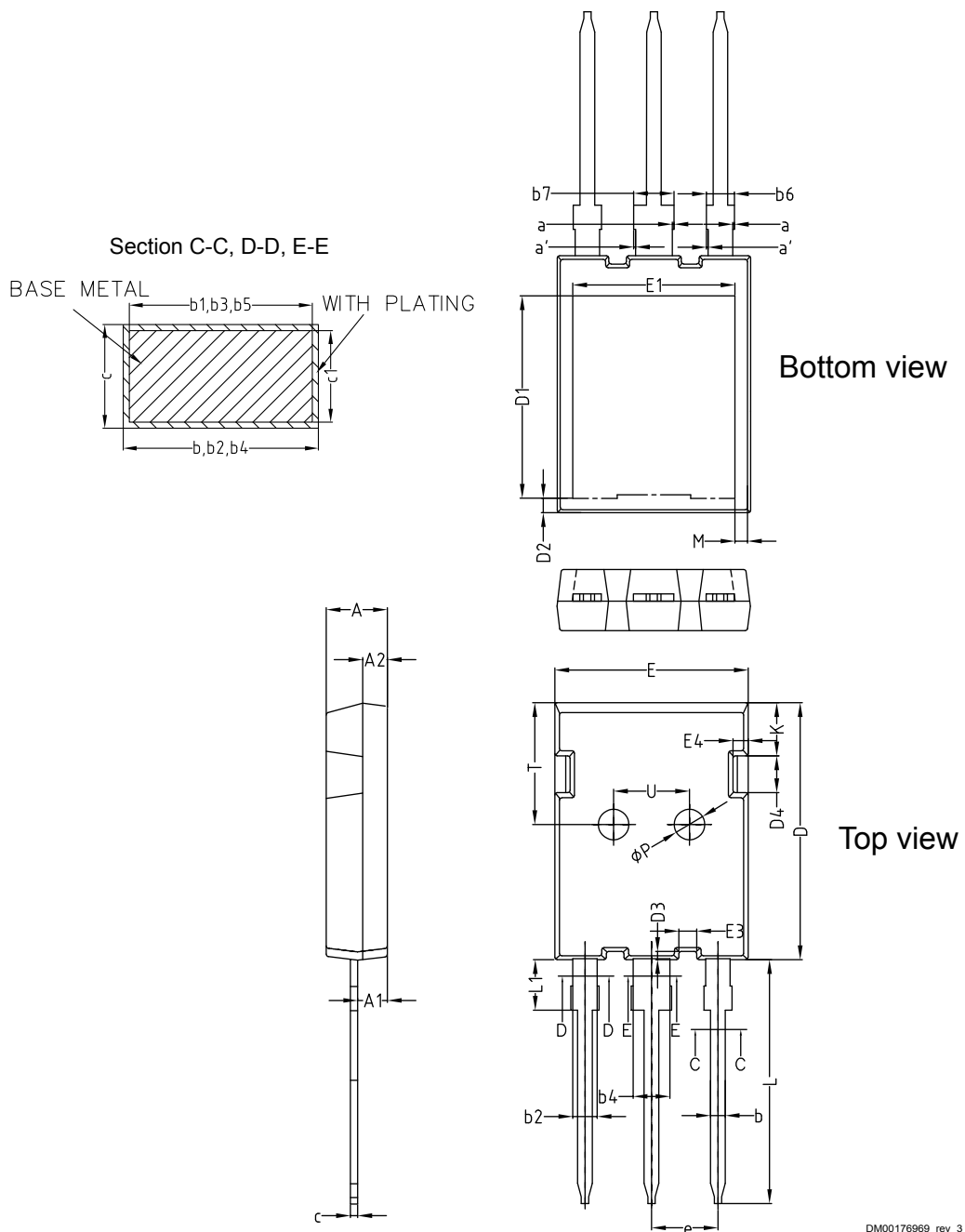
In order to meet environmental requirements, ST offers these devices in different grades of **ECOPACK** packages, depending on their level of environmental compliance. ECOPACK specifications, grade definitions and product status are available at: www.st.com. ECOPACK is an ST trademark.

4.1 Max247 long leads package information

Figure 32. Max247 long leads package outline



DM00176969_rev_3

Table 7. Max247 long leads package mechanical data

Dim.	mm		
	Min.	Typ.	Max.
A	4.90	5.00	5.10
A1	2.31	2.41	2.51
A2	1.90	2.00	2.10
a	0		0.15
a'	0		0.15
b	1.16		1.26
b1	1.15	1.20	1.22
b2	1.96		2.06
b3	1.95	2.00	2.02
b4	2.96		3.06
b5	2.95	3.00	3.02
b6			2.25
b7			3.25
c	0.59		0.66
c1	0.58	0.60	0.62
D	20.90	21.00	21.10
D1	16.25	16.55	16.85
D2	1.05	1.17	1.35
D3	0.58	0.68	0.78
D4	2.90	3.00	3.10
E	15.70	15.80	15.90
E1	13.10	13.26	13.50
E3	1.35	1.45	1.55
E4	1.14	1.24	1.34
e	5.34	5.44	5.54
K	4.25	4.35	4.45
L	19.80	19.92	20.10
L1	3.90		4.30
M	0.70		1.30
P	2.40	2.50	2.60
T	9.80		10.20
U	6.00		6.40

Revision history

Table 8. Document revision history

Date	Revision	Changes
06-Apr-2016	1	First release.
10-May-2016	2	Document status promoted to production data. Added Section 2.1: "Electrical characteristics (curves)"
15-Jun-2016	3	Updated Figure 1: "Internal schematic diagram" and Table 2: "Absolute maximum ratings". Updated Section 2.1: "Electrical characteristics (curves)". Minor text changes.
12-Aug-2016	4	Updated Table 7: "Diode switching characteristics (inductive load)" and Figure 25: "Reverse recovery charge vs. diode current slope". Minor text changes.
13-Sep-2017	5	Updated title, features and application in cover page. Updated Figure 13: "Normalized $V(BR)_{CES}$ vs. junction temperature". Minor text changes.
07-Feb-2023	6	Updated Section 4.1 Max247 long leads package information. Minor text changes.

Contents

1	Electrical ratings	2
2	Electrical characteristics	3
2.1	Electrical characteristics (curves)	5
3	Test circuits	10
4	Package information	11
4.1	Max247 long leads package information	11
	Revision history	13

IMPORTANT NOTICE – READ CAREFULLY

STMicroelectronics NV and its subsidiaries (“ST”) reserve the right to make changes, corrections, enhancements, modifications, and improvements to ST products and/or to this document at any time without notice. Purchasers should obtain the latest relevant information on ST products before placing orders. ST products are sold pursuant to ST’s terms and conditions of sale in place at the time of order acknowledgment.

Purchasers are solely responsible for the choice, selection, and use of ST products and ST assumes no liability for application assistance or the design of purchasers’ products.

No license, express or implied, to any intellectual property right is granted by ST herein.

Resale of ST products with provisions different from the information set forth herein shall void any warranty granted by ST for such product.

ST and the ST logo are trademarks of ST. For additional information about ST trademarks, refer to www.st.com/trademarks. All other product or service names are the property of their respective owners.

Information in this document supersedes and replaces information previously supplied in any prior versions of this document.

© 2023 STMicroelectronics – All rights reserved