

Phase out

## Standard Rectifier Module

**PHASE OUT**

3~ Rectifier Bridge

<b>3~ Rectifier</b>
$V_{RRM} = 1400\text{ V}$
$I_{DAV} = 240\text{ A}$
$I_{FSM} = 2800\text{ A}$

Part number

VUO190-14NO7

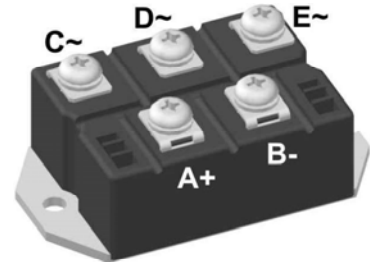

E72873

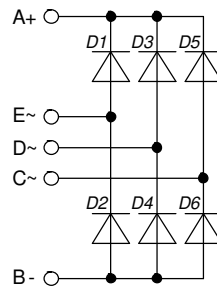
**Features / Advantages:**

- Package with DCB ceramic
- Improved temperature and power cycling
- Planar passivated chips
- Very low forward voltage drop
- Very low leakage current

**Applications:**

- Diode for main rectification
- For three phase bridge configurations
- Supplies for DC power equipment
- Input rectifiers for PWM inverter
- Battery DC power supplies
- Field supply for DC motors

**Package: PWS-E**

- Isolation Voltage: 3000 V~
- Industry standard outline
- RoHS compliant
- Easy to mount with two screws
- Base plate: Copper internally DCB isolated
- Advanced power cycling

**Recommended replacement: VUO190-16NO7**

**Terms and Conditions of Usage**

The data contained in this product data sheet is exclusively intended for technically trained staff. The user will have to evaluate the suitability of the product for the intended application and the completeness of the product data with respect to his application. The specifications of our components may not be considered as an assurance of component characteristics. The information in the valid application- and assembly notes must be considered. Should you require product information in excess of the data given in this product data sheet or which concerns the specific application of your product, please contact your local sales office.

Due to technical requirements our product may contain dangerous substances. For information on the types in question please contact your local sales office.

Should you intend to use the product in aviation, in health or life endangering or life support applications, please notify. For any such application we urgently recommend

- to perform joint risk and quality assessments;

- the conclusion of quality agreements;

- to establish joint measures of an ongoing product survey, and that we may make delivery dependent on the realization of any such measures.

Rectifier				Ratings				
Symbol	Definition	Conditions		min.	typ.	max.	Unit	
$V_{RSM}$	max. non-repetitive reverse blocking voltage			$T_{VJ} = 25^{\circ}\text{C}$		1500	V	
$V_{RRM}$	max. repetitive reverse blocking voltage			$T_{VJ} = 25^{\circ}\text{C}$		1400	V	
$I_R$	reverse current	$V_R = 1400\text{ V}$		$T_{VJ} = 25^{\circ}\text{C}$		200	$\mu\text{A}$	
		$V_R = 1400\text{ V}$		$T_{VJ} = 150^{\circ}\text{C}$		3.5	mA	
$V_F$	forward voltage drop	$I_F = 80\text{ A}$		$T_{VJ} = 25^{\circ}\text{C}$		1.07	V	
						$I_F = 240\text{ A}$	1.36	V
		$I_F = 80\text{ A}$		$T_{VJ} = 125^{\circ}\text{C}$		0.96	V	
						$I_F = 240\text{ A}$	1.33	V
$I_{DAV}$	bridge output current	$T_C = 110^{\circ}\text{C}$	rectangular	$d = 1/3$	$T_{VJ} = 150^{\circ}\text{C}$		240	A
$V_{F0}$	threshold voltage	} for power loss calculation only		$T_{VJ} = 150^{\circ}\text{C}$		0.74	V	
$r_F$	slope resistance					2.4	m $\Omega$	
$R_{thJC}$	thermal resistance junction to case					0.4	K/W	
$R_{thCH}$	thermal resistance case to heatsink				0.15		K/W	
$P_{tot}$	total power dissipation			$T_C = 25^{\circ}\text{C}$		310	W	
$I_{FSM}$	max. forward surge current	$t = 10\text{ ms}; (50\text{ Hz}), \text{ sine}$		$T_{VJ} = 45^{\circ}\text{C}$		2.80	kA	
		$t = 8,3\text{ ms}; (60\text{ Hz}), \text{ sine}$		$V_R = 0\text{ V}$		3.03	kA	
		$t = 10\text{ ms}; (50\text{ Hz}), \text{ sine}$		$T_{VJ} = 150^{\circ}\text{C}$		2.38	kA	
		$t = 8,3\text{ ms}; (60\text{ Hz}), \text{ sine}$		$V_R = 0\text{ V}$		2.57	kA	
$I^2t$	value for fusing	$t = 10\text{ ms}; (50\text{ Hz}), \text{ sine}$		$T_{VJ} = 45^{\circ}\text{C}$		39.2	kA <sup>2</sup> s	
		$t = 8,3\text{ ms}; (60\text{ Hz}), \text{ sine}$		$V_R = 0\text{ V}$		38.1	kA <sup>2</sup> s	
		$t = 10\text{ ms}; (50\text{ Hz}), \text{ sine}$		$T_{VJ} = 150^{\circ}\text{C}$		28.3	kA <sup>2</sup> s	
		$t = 8,3\text{ ms}; (60\text{ Hz}), \text{ sine}$		$V_R = 0\text{ V}$		27.5	kA <sup>2</sup> s	
$C_J$	junction capacitance	$V_R = 400\text{ V}; f = 1\text{ MHz}$		$T_{VJ} = 25^{\circ}\text{C}$		133	pF	

# PHASE OUT

Phase out

Package PWS-E			Ratings			
Symbol	Definition	Conditions	min.	typ.	max.	Unit
$I_{RMS}$	RMS current	per terminal			250	A
$T_{VJ}$	virtual junction temperature		-40		150	°C
$T_{op}$	operation temperature		-40		125	°C
$T_{stg}$	storage temperature		-40		125	°C
<b>Weight</b>				284		g
$M_D$	mounting torque		4.25		5.75	Nm
$M_T$	terminal torque		4.25		5.75	Nm
$d_{Spp/App}$	creepage distance on surface   striking distance through air	terminal to terminal	12.0			mm
$d_{Spb/Appb}$		terminal to backside	26.0			mm
$V_{ISOL}$	isolation voltage	t = 1 second	3000			V
		t = 1 minute	2500			V

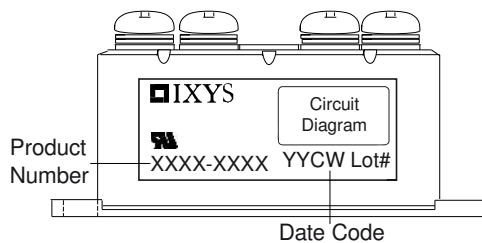

Ordering	Ordering Number	Marking on Product	Delivery Mode	Quantity	Code No.
Standard	VUO190-14NO7	VUO190-14NO7	Box	5	462500

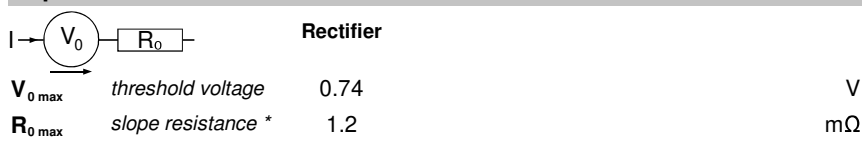
**Equivalent Circuits for Simulation** \* on die level  $T_{VJ} = 150\text{ °C}$ 

Outlines PWS-E

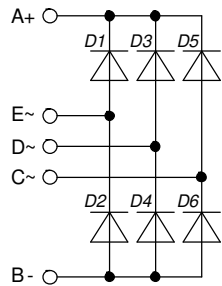
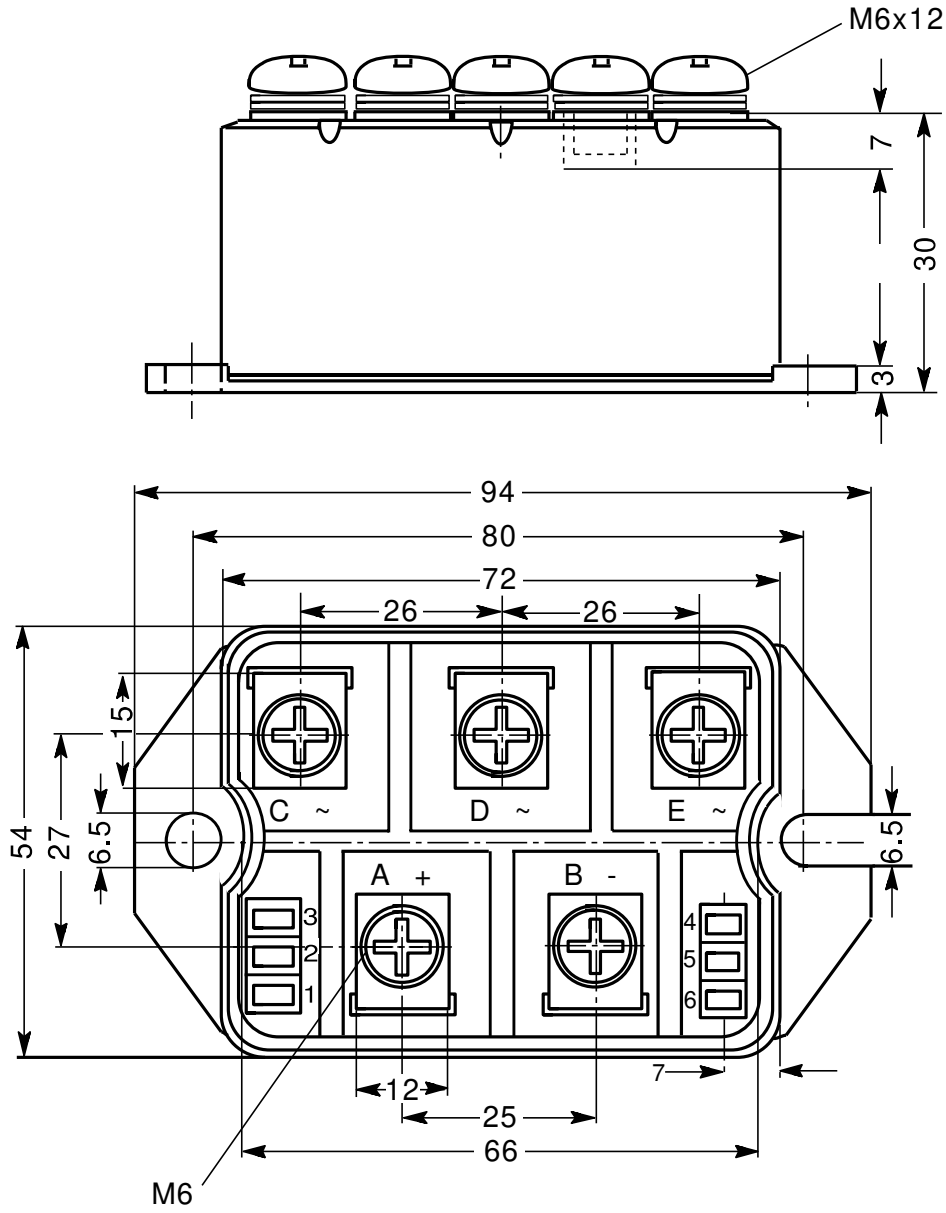

Rectifier

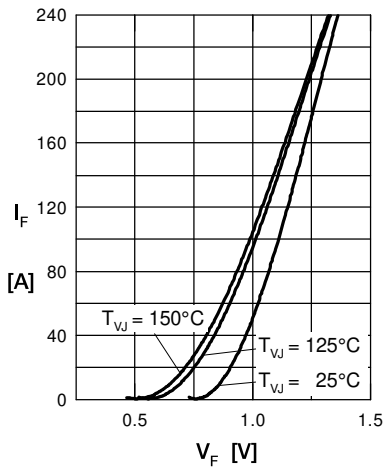

Fig. 1 Forward current vs. voltage drop per diode

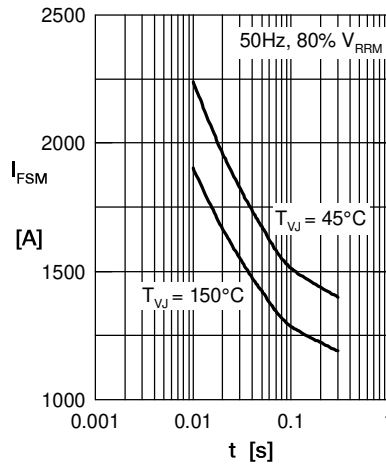

Fig. 2 Surge overload current vs. time per diode

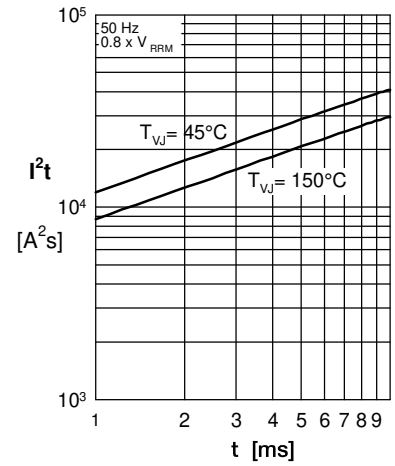

Fig. 3  $I^2t$  vs. time per diode

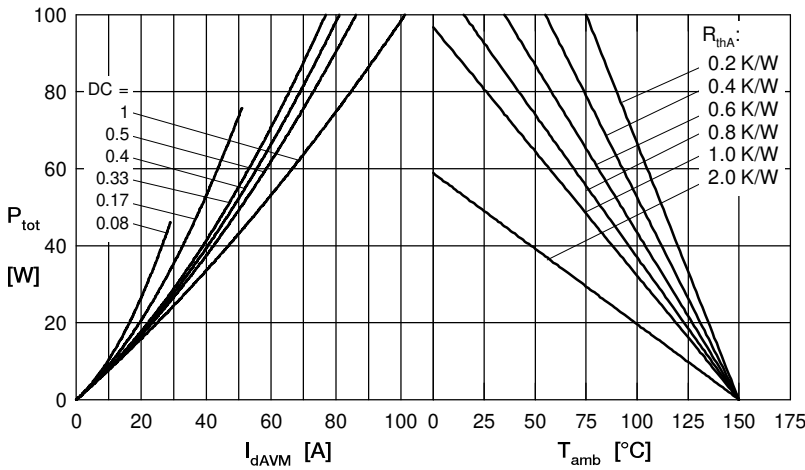

Fig. 4 Power dissipation vs. forward current and ambient temperature per diode

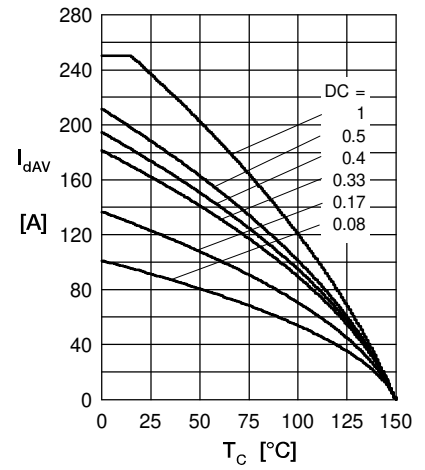

Fig. 5 Max. forward current vs. case temperature per diode

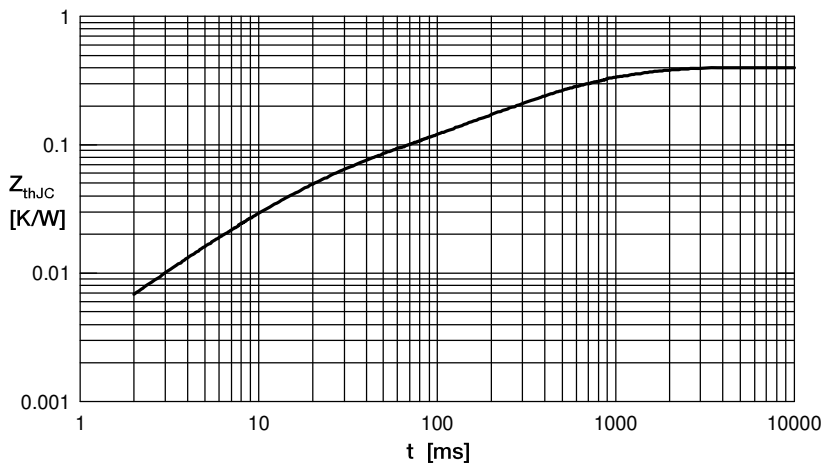

Fig. 6 Transient thermal impedance junction to case vs. time per diode

$R_i$	$t_i$
0.050	0.02
0.003	0.01
0.100	0.225
0.177	0.8
0.070	0.58