

4000012662

POSITION OF COLOUR STRIPE (see note 3)

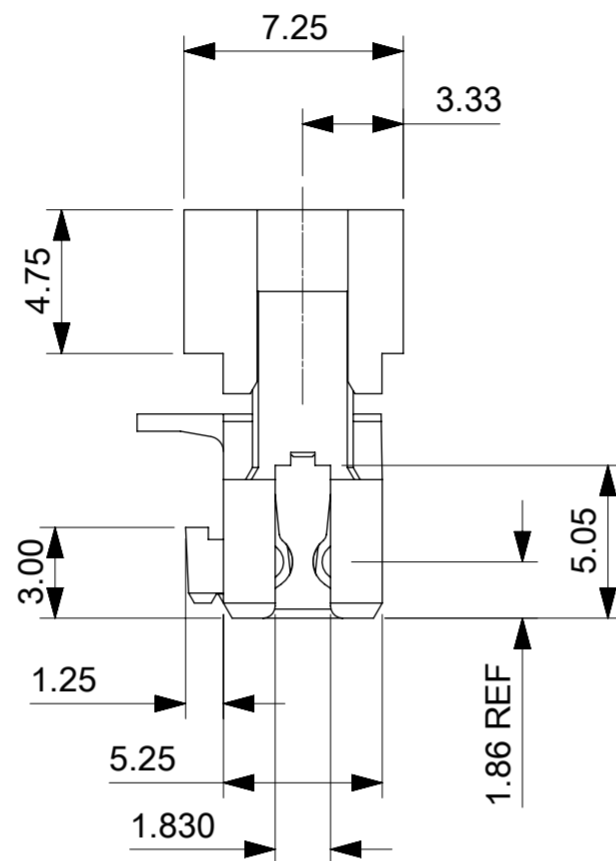

POSITION KEYS

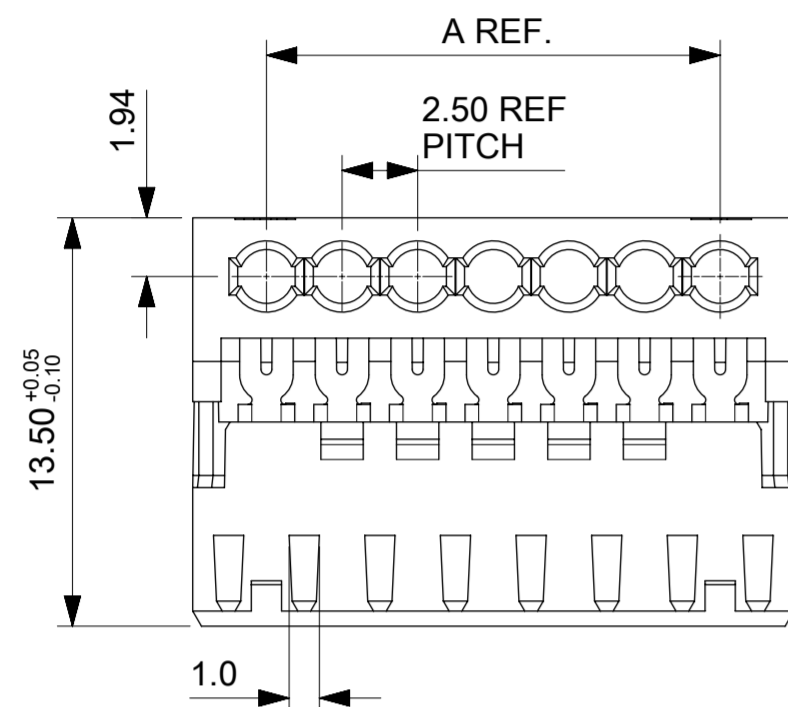
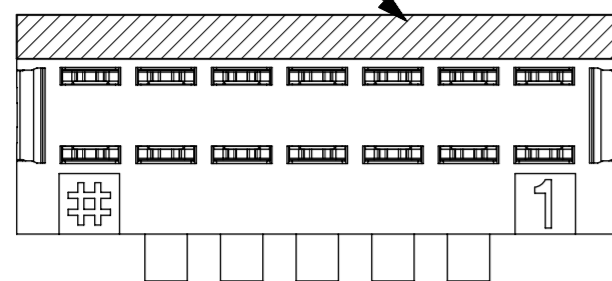
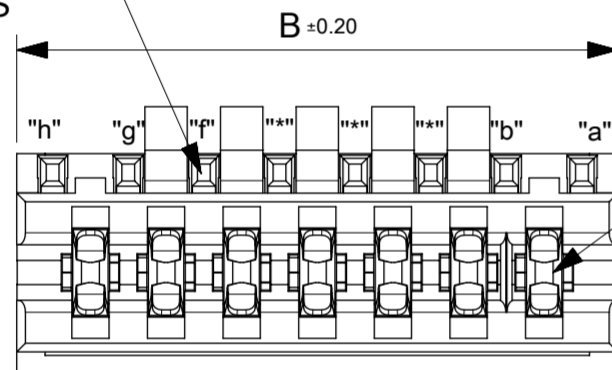

CIRCUIT 1

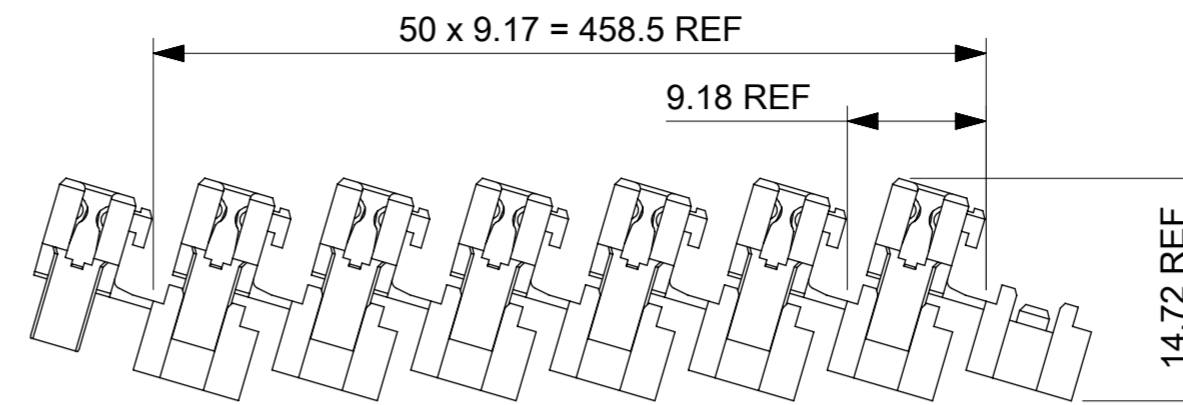

SHIPPING ARRANGEMENT

CCT	A	B
3	5.0	9.875
4	7.5	12.375
5	10.0	14.875
6	12.5	17.375
7	15.0	19.875
8	17.5	22.375
9	20.0	24.875
10	22.5	27.375
11	25.0	29.875
12	27.5	32.375
13	30.0	34.875
14	32.5	37.375
15	35.0	39.875
16	37.5	42.375
17	40.0	44.875
18	42.5	47.375
19	45.0	49.875
20	47.5	52.375

OPTIONAL PART FEATURES

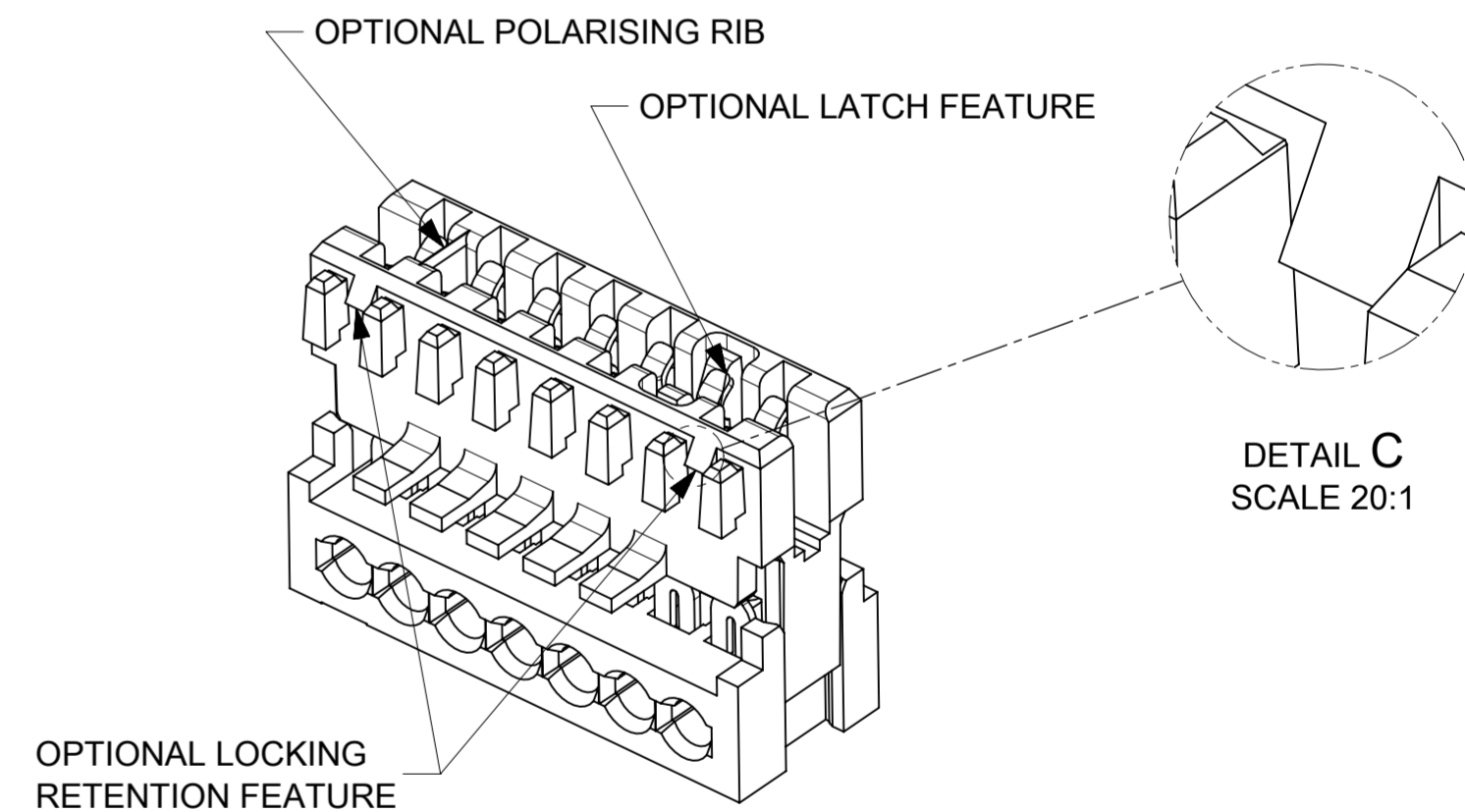

SEE SUBSEQUENT SHEETS FOR RELEVANT PART NUMBERS.  
 \*LOCKING RETENTION FEATURE AVAILABLE FIRST AND LAST CIRCUIT ONLY  
 SMALLEST CIRCUIT SIZE AVAILABLE WITH LOCKING RETENTION FEATURE IS 5 CKT

- NOTES:
- REFER TO PRODUCT SPECIFICATION: PS-99020-0040.
  - MATERIAL: HOUSING - NYLON PA6 UL94-VO, COLOUR: NATURAL (WHITE).  
 TERMINAL: PHOSPHOR BRONZE 0.30 REF. THICK - PLATING HOT TIN DIP.
  - COLOUR STRIPE IS OPTIONAL. AVAILABLE IN THE FOLLOWING COLOURS: RED, GREEN, BLUE, PURPLE (BOLD SIGNIFIES CUSTOMER SPECIFIC CONFIGURATION).
  - REFER TO PACKAGING SPEC (PK-90871-001)
  - REFER TO APPLICATION SPEC (990330008 AS)
  - RIB THICKNESS = 0.38mm

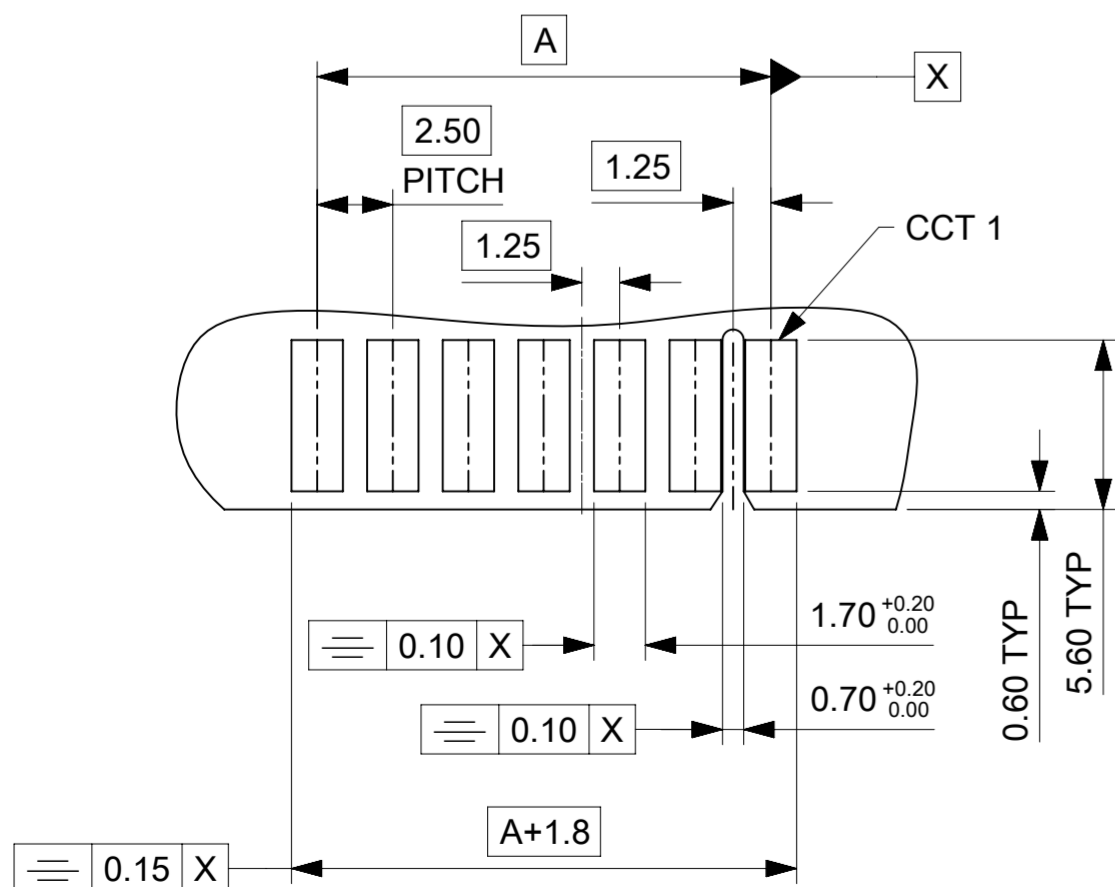

- PCB LAYOUT FOR 7CCT (2.5mm) CONNECTOR  
 (WITH OPTIONAL POSITIONAL RIB SLOT BETWEEN CCT 1 & 2)  
 - RECOMMENDED PCB THICKNESS 1.5±0.14

THIS DRAWING CONTAINS INFORMATION THAT IS PROPRIETARY TO MOLEX ELECTRONIC TECHNOLOGIES, LLC AND SHOULD NOT BE USED WITHOUT WRITTEN PERMISSION										
DIMENSION UNITS		SCALE		CURRENT REV DESC:						
mm		NTS								
GENERAL TOLERANCES (UNLESS SPECIFIED)										
ANGULAR TOL ± 0.5°				EC NO: 743071						
4 PLACES ±		DRWN: RAHULH3		2023/03/21						
3 PLACES ± 0.05		CHK'D: RAHULH3		2023/03/21						
2 PLACES ± 0.1		APPR: MRAMAKRISHNA		2023/03/21						
1 PLACE ± 0.2		INITIAL REVISION:								
0 PLACES ±		DRWN: CFISHER01		2016/05/06						
		APPR: BRUTTLE		2016/07/01						
DRAFT WHERE APPLICABLE MUST REMAIN WITHIN DIMENSIONS			THIRD ANGLE PROJECTION		DRAWING		SERIES		MATERIAL NUMBER	
			A2-SIZE		91716		SEE TABLE		CUSTOMER	
			GENERAL MARKET		1 OF 10					



APPLI-MATE 2.5 FEMALE (MATL: NYLON PA6)

PRODUCT CUSTOMER DRAWING

917160001

PSD 000 N4

2 CIRCUIT									
PART NUMBER	HOUSING USED	TERMINAL VOID POSITION	LATCH POSITION	REMOVED POSITION KEYS	CONFIGURATION	FIRST ENDWALL	LAST ENDWALL	POLARIZING RIB BETWEEN	COLOUR STRIPE
91716-9001	91715-0002	NONE	NONE	NONE		OPEN	OPEN	NONE	NONE
91716-9002	91715-0042	NONE	NONE	a		OPEN	CLOSED	NONE	NONE
91716-9004	91715-0002	NONE	NONE	c		OPEN	OPEN	NONE	NONE
91716-9005	91715-0102	NONE	NONE	NONE		OPEN	OPEN	1&2	NONE

3 CIRCUIT									
PART NUMBER	HOUSING USED	TERMINAL VOID POSITION	LATCH POSITION	REMOVED POSITION KEYS	CONFIGURATION	FIRST ENDWALL	LAST ENDWALL	POLARIZING RIB BETWEEN	COLOUR STRIPE
91716-0001	91715-0003	NONE	NONE	NONE		OPEN	OPEN	NONE	NONE
91716-0002	91715-0003	NONE	NONE	a d		OPEN	OPEN	NONE	RED
91716-0013	91715-0003	NONE	NONE	a		OPEN	OPEN	NONE	NONE
91716-0014	91715-0003	NONE	NONE	b		OPEN	OPEN	NONE	NONE
91716-0015	91715-0003	NONE	NONE	c		OPEN	OPEN	NONE	NONE
91716-0016	91715-0003	NONE	NONE	d		OPEN	OPEN	NONE	NONE
91716-0017	91715-0003	NONE	NONE	b d		OPEN	OPEN	NONE	NONE
91716-0018	91715-0003	NONE	NONE	a c		OPEN	OPEN	NONE	NONE
91716-0019	91715-0003	NONE	NONE	a d		OPEN	OPEN	NONE	NONE
91716-0020	91715-0003	NONE	NONE	a b		OPEN	OPEN	NONE	NONE
91716-0021	91715-0003	NONE	NONE	b c		OPEN	OPEN	NONE	NONE
91716-0022	91715-0003	NONE	NONE	c d		OPEN	OPEN	NONE	NONE
91716-0023	91715-0003	CCT 2	NONE	b d		OPEN	OPEN	NONE	NONE
91716-0024	91715-0003	CCT 3	NONE	c		OPEN	OPEN	NONE	BLUE
91716-0034	91715-0103	NONE	NONE	NONE		OPEN	OPEN	1&2	NONE
91716-0041	91715-0203	NONE	NONE	NONE		OPEN	OPEN	2&3	NONE
91716-0042	91715-0003	CCT 1	NONE	NONE		OPEN	OPEN	NONE	NONE
91716-0043	91715-0003	CCT 1	NONE	c		OPEN	OPEN	NONE	NONE
91716-0044	91715-0003	NONE	NONE	b d		OPEN	OPEN	NONE	BLUE
91716-0045	91715-0003	NONE	NONE	b		OPEN	OPEN	NONE	BLUE
91716-0046	91715-0003	CCT 1	NONE	d		OPEN	OPEN	NONE	NONE

3CCT CONTINUED ON NEXT SHEET

NOTES

- + DENOTES TERMINAL VOIDED POSITION
- ⊕ DENOTES TERMINAL LOADED POSITION
- | DENOTES POLARIZING RIB POSITION
- MOLEX HOUSING NO. FOR REFERENCE ONLY

THIS DRAWING CONTAINS INFORMATION THAT IS PROPRIETARY TO MOLEX ELECTRONIC TECHNOLOGIES, LLC AND SHOULD NOT BE USED WITHOUT WRITTEN PERMISSION									
DIMENSION UNITS		SCALE		CURRENT REV DESC:					
mm		NTS							
GENERAL TOLERANCES (UNLESS SPECIFIED)								APPLI-MATE 2.5 FEMALE (MATL: NYLON PA6)	
ANGULAR TOL ± 0.5°				EC NO: 743071					
4 PLACES ±		0.05		DRWN: RAHULH3		2023/03/21		PRODUCT CUSTOMER DRAWING	
3 PLACES ±		0.1		CHK'D: RAHULH3		2023/03/21			
2 PLACES ±		0.1		APPR: MRAMAKRISHNA		2023/03/21			
1 PLACE ±		0.2		INITIAL REVISION:				DOCUMENT NUMBER	
0 PLACES ±				DRWN: CFISHER01		2016/05/06		917160001	
				APPR: BRUTTLE		2016/07/01		DOC TYPE   DOC PART   REVISION	
DRAFT WHERE APPLICABLE MUST REMAIN WITHIN DIMENSIONS		THIRD ANGLE PROJECTION		DRAWING		SERIES		MATERIAL NUMBER   CUSTOMER   SHEET NUMBER	
				A2-SIZE		91716		SEE TABLE   GENERAL MARKET   2 OF 10	

### 3 CIRCUIT

PART NUMBER	HOUSING USED	TERMINAL VOID POSITION	LATCH POSITION	REMOVED POSITION KEYS	CONFIGURATION	FIRST ENDWALL	LAST ENDWALL	POLARIZING RIB BETWEEN	COLOUR STRIPE
91716-0047	91715-0003	NONE	NONE	b d		OPEN	OPEN	NONE	RED
91716-0048	91715-0003	NONE	NONE	b c d		OPEN	OPEN	NONE	NONE
91716-0049	91715-0003	NONE	NONE	c		OPEN	OPEN	NONE	PURPLE
91716-0050	91715-9903	NONE	NONE	NONE		OPEN	NARROW	NONE	NONE
91716-0051	91715-0003	NONE	NONE	d		OPEN	OPEN	NONE	BLACK
91716-0053	91715-0043	NONE	NONE	d		OPEN	CLOSED	NONE	NONE
91716-0054	91715-0243	NONE	NONE	NONE		OPEN	CLOSED	2&3	NONE
91716-0055	91715-0043	NONE	NONE	a		OPEN	CLOSED	NONE	NONE
91716-0056	91715-0063	NONE	NONE	c		CLSIED	OPEN	NONE	NONE
91716-0058	91715-0003	CCT 3	NONE	d		OPEN	OPEN	NONE	NONE
91716-0059	91715-0003	CCT 3	NONE	c d		OPEN	OPEN	NONE	NONE

### 4 CIRCUIT

PART NUMBER	HOUSING USED	TERMINAL VOID POSITION	LATCH POSITION	REMOVED POSITION KEYS	CONFIGURATION	FIRST ENDWALL	LAST ENDWALL	POLARIZING RIB BETWEEN	COLOUR STRIPE
91716-0501	91715-0004	NONE	NONE	NONE		OPEN	OPEN	NONE	NONE
91716-0502	91715-0004	NONE	NONE	d		OPEN	OPEN	NONE	NONE
91716-0503	91715-0004	NONE	NONE	a d		OPEN	OPEN	NONE	NONE
91716-0504	91715-0004	NONE	NONE	c e		OPEN	OPEN	NONE	NONE
91716-0505	91715-0004	NONE	NONE	a		OPEN	OPEN	NONE	NONE
91716-0506	91715-0204	NONE	NONE	NONE		OPEN	OPEN	2&3	NONE
91716-0538	91715-0004	NONE	NONE	b		OPEN	OPEN	NONE	NONE
91716-0530	91715-0004	NONE	NONE	b c		OPEN	OPEN	NONE	NONE
91716-0539	91715-0004	NONE	NONE	a b		OPEN	OPEN	NONE	NONE
91716-0540	91715-0004	NONE	NONE	d e		OPEN	OPEN	NONE	NONE
91716-0541	91715-0004	NONE	NONE	ALL		OPEN	OPEN	NONE	NONE
91716-0542	91715-0004	NONE	NONE	a b e		OPEN	OPEN	NONE	NONE
91716-0507	91715-0004	CCT 1	NONE	NONE		OPEN	OPEN	NONE	NONE
91716-0543	91715-0304	NONE	NONE	NONE		OPEN	OPEN	3&4	RED
91716-0544	91715-0204	NONE	NONE	NONE		OPEN	OPEN	2&3	BLUE
91716-0545	91715-0004	NONE	NONE	d		OPEN	OPEN	NONE	BLUE

### 4 CIRCUIT

PART NUMBER	HOUSING USED	TERMINAL VOID POSITION	LATCH POSITION	REMOVED POSITION KEYS	CONFIGURATION	FIRST ENDWALL	LAST ENDWALL	POLARIZING RIB BETWEEN	COLOUR STRIPE
91716-0546	91715-0004	NONE	NONE	b		OPEN	OPEN	NONE	RED
91716-0547	91715-0004	NONE	NONE	b c		OPEN	OPEN	NONE	GREEN
91716-0548	91715-0004	NONE	NONE	c d		OPEN	OPEN	NONE	RED
91716-0549	91715-0004	NONE	NONE	a c e		OPEN	OPEN	NONE	NONE
91716-0550	91715-0104	NONE	NONE	NONE		OPEN	OPEN	1&2	NONE
91716-0551	91715-0004	NONE	NONE	NONE		OPEN	OPEN	NONE	GREEN
91716-0552	91715-0004	NONE	NONE	b c d		OPEN	OPEN	NONE	NONE
91716-0553	91715-0004	NONE	NONE	b d		OPEN	OPEN	NONE	NONE
91716-0554	91715-0004	NONE	NONE	a b d		OPEN	OPEN	NONE	NONE
91716-0555	91715-0004	NONE	NONE	a c e		OPEN	OPEN	NONE	BLACK
91716-0556	91715-0004	NONE	NONE	a e		OPEN	OPEN	NONE	NONE
91716-0557	91715-0104	NONE	NONE	a b d e		OPEN	OPEN	1&2	NONE
91716-0558	91715-0004	NONE	NONE	a c		OPEN	OPEN	NONE	NONE
91716-0559	91715-0004	NONE	NONE	b e		OPEN	OPEN	NONE	NONE
91716-0560	91715-0004	NONE	NONE	a d e		OPEN	OPEN	NONE	NONE

#### NOTES

- + DENOTES TERMINAL VOIDED POSITION  
⊕ DENOTES TERMINAL LOADED POSITION  
| DENOTES POLARIZING RIB POSITION
- MOLEX HOUSING NO. FOR REFERENCE ONLY

THIS DRAWING CONTAINS INFORMATION THAT IS PROPRIETARY TO MOLEX ELECTRONIC TECHNOLOGIES, LLC AND SHOULD NOT BE USED WITHOUT WRITTEN PERMISSION									
DIMENSION UNITS		SCALE		CURRENT REV DESC:					
mm		NTS							
GENERAL TOLERANCES (UNLESS SPECIFIED)				EC NO: 743071 DRWN: RAHULH3 CHK'D: RAHULH3 APPR: MRAMAKRISHNA INITIAL REVISION: DRWN: CFISHER01 APPR: BRUTTLE					
ANGULAR TOL ± 0.5°									
4 PLACES ±		2023/03/21							
3 PLACES ± 0.05		2023/03/21							
2 PLACES ± 0.1		2023/03/21							
1 PLACE ± 0.2		2016/05/06		DOCUMENT NUMBER					
0 PLACES ±		2016/07/01		917160001					
DRAFT WHERE APPLICABLE MUST REMAIN WITHIN DIMENSIONS		THIRD ANGLE PROJECTION		DRAWING		SERIES		MATERIAL NUMBER	
				A2-SIZE		91716		SEE TABLE	
				CUSTOMER		REVISION		SHEET NUMBER	
				GENERAL MARKET		N4		3 OF 10	

**molex**

APPLI-MATE 2.5 FEMALE  
(MATL: NYLON PA6)

PRODUCT CUSTOMER DRAWING

917160001

PSD 000 N4

# 5 CIRCUIT

PART NUMBER	HOUSING USED	TERMINAL VOID POSITION	LATCH POSITION	REMOVED POSITION KEYS	CONFIGURATION	FIRST ENDWALL	LAST ENDWALL	POLARIZING RIB BETWEEN	COLOUR STRIPE	
91716-1001	91715-0005	NONE	NONE	NONE		OPEN	OPEN	NONE	NONE	
91716-1002	91715-0305	NONE	NONE	ALL		OPEN	OPEN	3&4	NONE	
91716-1003	91715-0405	NONE	NONE	NONE		OPEN	OPEN	4&5	NONE	
91716-1004	91715-0005	NONE	NONE	c d		OPEN	OPEN	NONE	NONE	
91716-1005	91715-0005	NONE	NONE	a		OPEN	OPEN	NONE	NONE	
91716-1006	91715-0005	NONE	NONE	b		OPEN	OPEN	NONE	NONE	
91716-1007	91715-0005	NONE	NONE	a b e f		OPEN	OPEN	NONE	NONE	
91716-1008	91715-0205	NONE	NONE	NONE		OPEN	OPEN	2&3	NONE	
91716-1009	91715-0005	CCT 2,3,4	NONE	NONE		OPEN	OPEN	NONE	NONE	
91716-1010	91715-0005	CCT 2	NONE	c		OPEN	OPEN	NONE	NONE	
91716-1011	91715-0005	CCT 2	NONE	d		OPEN	OPEN	NONE	NONE	
91716-1012	91715-0005	CCT 2	NONE	b		OPEN	OPEN	NONE	NONE	
91716-1013	91715-0005	CCT 2	NONE	a		OPEN	OPEN	NONE	NONE	
91716-1014	91715-0005	NONE	NONE	b c d e		OPEN	OPEN	NONE	NONE	
91716-1015	91715-0305	CCT 2,3,4	NONE	NONE		OPEN	OPEN	3&4	RED	
91716-1016	91715-0005	CCT 2	NONE	b		OPEN	OPEN	NONE	RED	
91716-1017	91715-0005	NONE	NONE	d e		OPEN	OPEN	NONE	NONE	
91716-1018	91715-0005	NONE	NONE	a d f		OPEN	OPEN	NONE	NONE	
91716-1019	91715-0105	NONE	NONE	NONE		OPEN	OPEN	1&2	NONE	
91716-1020	91715-0005	CCT 2,3,4	NONE	b		OPEN	OPEN	NONE	NONE	
91716-1021	91715-0005	NONE	NONE	d		OPEN	OPEN	NONE	NONE	
91716-1022	91715-0005	NONE	NONE	b f		OPEN	OPEN	NONE	RED	
91716-1023	91715-0005	CCT 2,3,4	NONE	c e		OPEN	OPEN	NONE	NONE	
91716-1024	91715-0205	NONE	NONE	a b e f		OPEN	OPEN	2&3	NONE	
91716-1025	91715-0005	CCT 2,3,4	NONE	c f		OPEN	OPEN	NONE	NONE	
91716-1026	93473-0205	NONE	NONE	ALL		OPEN	OPEN	2&3	NONE	LOCKING RETENTION FEATURE
91716-1027	91715-0205	NONE	NONE	ALL		OPEN	OPEN	2&3	NONE	LOCKING RETENTION FEATURE
91716-1028	93473-0005	NONE	NONE	NONE		OPEN	OPEN	NONE	NONE	LOCKING RETENTION FEATURE
91716-1029	91715-0005	NONE	NONE	b c d		OPEN	OPEN	NONE	NONE	
91716-1030	91715-0085	NONE	NONE	NONE		NARROW	OPEN	NONE	NONE	

# 5 CIRCUIT

PART NUMBER	HOUSING USED	TERMINAL VOID POSITION	LATCH POSITION	REMOVED POSITION KEYS	CONFIGURATION	FIRST ENDWALL	LAST ENDWALL	POLARIZING RIB BETWEEN	COLOUR STRIPE
91716-1031	91715-0305	NONE	NONE	b c d e f		OPEN	OPEN	3 & 4	NONE
91716-1032	91715-0405	NONE	NONE	b c d e f		OPEN	OPEN	4 & 5	NONE

(N3)

### NOTES

- + DENOTES TERMINAL VOIDED POSITION  
⊕ DENOTES TERMINAL LOADED POSITION  
| DENOTES POLARIZING RIB POSITION
- MOLEX HOUSING NO. FOR REFERENCE ONLY

THIS DRAWING CONTAINS INFORMATION THAT IS PROPRIETARY TO MOLEX ELECTRONIC TECHNOLOGIES, LLC AND SHOULD NOT BE USED WITHOUT WRITTEN PERMISSION									
DIMENSION UNITS		SCALE		CURRENT REV DESC:					
mm		NTS		<p><b>molex</b></p> <p>APPLI-MATE 2.5 FEMALE (MATL: NYLON PA6)</p> <p>PRODUCT CUSTOMER DRAWING</p> <p>EC NO: 743071 DRWN: RAHULH3 2023/03/21 CHK'D: RAHULH3 2023/03/21 APPR: MRAMAKRISHNA 2023/03/21</p> <p>INITIAL REVISION: DRWN: CFISHER01 2016/05/06 APPR: BRUTTLE 2016/07/01</p> <p>DOCUMENT NUMBER: <b>917160001</b></p> <p>DOC TYPE: PSD DOC PART: 000 REVISION: <b>N4</b></p>					
GENERAL TOLERANCES (UNLESS SPECIFIED)									
ANGULAR TOL ± 0.5°									
4 PLACES ±									
3 PLACES ± 0.05									
2 PLACES ± 0.1									
1 PLACE ± 0.2									
0 PLACES ±									
DRAFT WHERE APPLICABLE MUST REMAIN WITHIN DIMENSIONS		THIRD ANGLE PROJECTION		DRAWING		SERIES		MATERIAL NUMBER	
				A2-SIZE		91716		SEE TABLE	
				CUSTOMER		SHEET NUMBER			
				GENERAL MARKET		4 OF 10			

6 CIRCUIT									
PART NUMBER	HOUSING USED	TERMINAL VOID POSITION	LATCH POSITION	REMOVED POSITION KEYS	CONFIGURATION	FIRST ENDWALL	LAST ENDWALL	POLARIZING RIB BETWEEN	COLOUR STRIPE
91716-1501	91715-0006	NONE	NONE	NONE		OPEN	OPEN	NONE	NONE
91716-1502	91715-0306	NONE	NONE	ALL		OPEN	OPEN	3&4	NONE
91716-1503	91715-0006	NONE	NONE	c e f g		OPEN	OPEN	NONE	NONE
91716-1504	91715-0206	NONE	NONE	ALL		OPEN	OPEN	2&3	NONE
91716-1505	91715-0006	CCT 2,5	NONE	d f		OPEN	OPEN	NONE	NONE
91716-1506	91715-0006	NONE	NONE	a b f g		OPEN	OPEN	NONE	NONE
91716-1507	91715-0006	NONE	NONE	e f		OPEN	OPEN	NONE	NONE
91716-1509	91715-0006	NONE	NONE	g		OPEN	OPEN	NONE	NONE
91716-1510	91715-0006	CCT 2	NONE	c f		OPEN	OPEN	NONE	NONE
91716-1511	91715-0006	CCT 2,5	NONE	NONE		OPEN	OPEN	NONE	NONE
91716-1512	91715-0006	CCT 3,5	NONE	NONE		OPEN	OPEN	NONE	NONE
91716-1513	91715-0006	CCT 2,4	NONE	b d e f		OPEN	OPEN	NONE	NONE
91716-1514	91715-0106	CCT 3,5	NONE	NONE		OPEN	OPEN	1&2	NONE
91716-1515	91715-0206	CCT 2,5	NONE	NONE		OPEN	OPEN	2&3	NONE
91716-1516	91715-0306	NONE	NONE	c f		OPEN	OPEN	3&4	NONE
91716-1517	91715-0006	NONE	NONE	c e		OPEN	OPEN	NONE	NONE
91716-1518	91715-0006	CCT 2,4	NONE	NONE		OPEN	OPEN	NONE	NONE
91716-1519	91715-0006	NONE	NONE	a c e		OPEN	OPEN	NONE	NONE
91716-1520	91715-0006	CCT 5	NONE	c e		OPEN	OPEN	NONE	NONE
91716-1521	91715-0006	CCT 2,4,5,6	NONE	c e		OPEN	OPEN	NONE	NONE
91716-1522	91715-0006	CCT 2,6	NONE	c e		OPEN	OPEN	NONE	NONE
91716-1523	91715-0406	NONE	NONE	NONE		OPEN	OPEN	4&5	NONE
91716-1524	91715-0006	CCT 2,4,5,6	NONE	NONE		OPEN	OPEN	NONE	NONE
91716-1525	91715-0006	CCT 2,6	NONE	NONE		OPEN	OPEN	NONE	NONE
91716-1526	91715-0006	CCT 2,5	NONE	NONE		OPEN	OPEN	NONE	NONE
91716-1527	91715-0006	CCT 2,5	NONE	c e		OPEN	OPEN	NONE	NONE
91716-1528	91715-0006	CCT 2,5	NONE	a b d f g		OPEN	OPEN	NONE	GREEN
91716-1529	91715-0006	NONE	NONE	d		OPEN	OPEN	NONE	NONE
91716-1531	91715-0006	CCT 1,2,3,5	NONE	NONE		OPEN	OPEN	NONE	NONE
91716-1532	91715-0006	CCT 1,2,3,5	NONE	d f		OPEN	OPEN	NONE	NONE

6 CIRCUIT									
PART NUMBER	HOUSING USED	TERMINAL VOID POSITION	LATCH POSITION	REMOVED POSITION KEYS	CONFIGURATION	FIRST ENDWALL	LAST ENDWALL	POLARIZING RIB BETWEEN	COLOUR STRIPE
91716-1534	91715-0006	CCT 3,4	NONE	b d f		OPEN	OPEN	NONE	NONE
91716-1535	91715-0006	CCT 4,5	NONE	b d f		OPEN	OPEN	NONE	NONE
91716-1536	91715-0206	NONE	NONE	NONE		OPEN	OPEN	2&3	NONE
91716-1537	91715-0006	NONE	NONE	d		OPEN	OPEN	NONE	BLUE
91716-1538	91715-0006	CCT 2,5	NONE	b d		OPEN	OPEN	NONE	NONE
91716-1539	91715-0006	CCT 5,6	NONE	c f		OPEN	OPEN	NONE	NONE
91716-1540	91715-0006	CCT 2,4	NONE	d e		OPEN	OPEN	NONE	GREEN
91716-1541	91715-0006	NONE	NONE	a f g		OPEN	OPEN	NONE	NONE
91716-1542	91715-0006	NONE	NONE	NONE		OPEN	OPEN	NONE	RED
91716-1543	91715-0506	NONE	NONE	NONE		OPEN	OPEN	5&6	NONE
91716-1544	91715-0006	NONE	NONE	c e g		OPEN	OPEN	NONE	RED
91716-1545	91715-0006	NONE	NONE	d f		OPEN	OPEN	NONE	BLACK
91716-1546	91715-0006	NONE	NONE	a d		OPEN	OPEN	NONE	NONE
91716-1547	91715-0006	NONE	NONE	b e f		OPEN	OPEN	NONE	NONE
91716-1548	91715-0006	NONE	NONE	c d e		OPEN	OPEN	NONE	NONE
91716-1549	91715-0406	NONE	NONE	NONE		OPEN	OPEN	4&5	NONE
91716-1550	91715-0006	NONE	NONE	b d f		OPEN	OPEN	NONE	NONE
91716-1551	91715-0006	NONE	NONE	a c e g		OPEN	OPEN	NONE	NONE
91716-1552	91715-0006	NONE	NONE	a b d f		OPEN	OPEN	NONE	NONE
91716-1553	91715-0006	CCT 2,5	NONE	c d		OPEN	OPEN	NONE	BLACK
91716-1554	91715-0006	CCT 2,4	NONE	b		OPEN	OPEN	NONE	RED
91716-1555	91715-0006	NONE	NONE	c f		OPEN	OPEN	NONE	NONE
91716-1556	91715-0006	NONE	NONE	b d e g		OPEN	OPEN	NONE	NONE
91716-1557	91715-0006	CCT 2,4	NONE	b g		OPEN	OPEN	NONE	RED
91716-1558	91715-0006	NONE	NONE	d f		OPEN	OPEN	NONE	NONE

6CCT CONTINUED ON NEXT SHEET

- NOTES
- + DENOTES TERMINAL VOIDED POSITION
  - ⊕ DENOTES TERMINAL LOADED POSITION
  - | DENOTES POLARIZING RIB POSITION
2. MOLEX HOUSING NO. FOR REFERENCE ONLY

THIS DRAWING CONTAINS INFORMATION THAT IS PROPRIETARY TO MOLEX ELECTRONIC TECHNOLOGIES, LLC AND SHOULD NOT BE USED WITHOUT WRITTEN PERMISSION

DIMENSION UNITS	SCALE	CURRENT REV DESC:			
mm	NTS				
GENERAL TOLERANCES (UNLESS SPECIFIED)		EC NO: 743071	<b>APPLI-MATE 2.5 FEMALE (MATL: NYLON PA6)</b>		
ANGULAR TOL	± 0.5°	DRWN: RAHULH3			
4 PLACES	±	2023/03/21	<b>PRODUCT CUSTOMER DRAWING</b>		
3 PLACES	± 0.05	CHK'D: RAHULH3			
2 PLACES	± 0.1	APPR: MRAMAKRISHNA	DOCUMENT NUMBER: <b>917160001</b>		
1 PLACE	± 0.2	2023/03/21			
0 PLACES	±	INITIAL REVISION:	DOC TYPE: PSD	DOC PART: 000	REVISION: N4
DRAFT WHERE APPLICABLE MUST REMAIN WITHIN DIMENSIONS		DRWN: CFISHER01	CUSTOMER: GENERAL MARKET		
THIRD ANGLE PROJECTION		2016/05/06			
DRAWING		APPR: BRUTTLE	SHEET NUMBER: 5 OF 10		
SERIES		2016/07/01			
DRAWING			MATERIAL NUMBER: SEE TABLE		
A2-SIZE					

# 6 CIRCUIT

PART NUMBER	HOUSING USED	TERMINAL VOID POSITION	LATCH POSITION	REMOVED POSITION KEYS	CONFIGURATION	FIRST ENDWALL	LAST ENDWALL	POLARIZING RIB BETWEEN	COLOUR STRIPE	
91716-1559	91715-0006	CCT 1	NONE	NONE		OPEN	OPEN	NONE	NONE	
91716-1560	91715-0006	NONE	NONE	a c e f g		OPEN	OPEN	NONE	NONE	
91716-1561	91715-0006	NONE	NONE	a d g		OPEN	OPEN	NONE	NONE	
91716-1562	91715-0006	NONE	NONE	a c d e f g		OPEN	OPEN	NONE	NONE	
91716-1563	91715-0006	CCT 5	NONE	a c d e f g		OPEN	OPEN	NONE	NONE	
91716-1564	91715-0006	CCT 6	NONE	a c d e f g		OPEN	OPEN	NONE	NONE	
91716-1565	91715-0006	CCT 5	NONE	NONE		OPEN	OPEN	NONE	NONE	
91716-1566	93473-0006	NONE	NONE	NONE		OPEN	OPEN	NONE	NONE	LOCKING RETENTION FEATURE
91716-1567	93473-0006	NONE	NONE	d f		OPEN	OPEN	NONE	NONE	LOCKING RETENTION FEATURE
91716-1568	93473-0006	CCT 1	NONE	NONE		OPEN	OPEN	NONE	NONE	LOCKING RETENTION FEATURE
91716-1569	93473-0006	NONE	NONE	a c d e f g		OPEN	OPEN	NONE	NONE	LOCKING RETENTION FEATURE
91716-1570	93473-0006	CCT 5	NONE	a c d e f g		OPEN	OPEN	NONE	NONE	LOCKING RETENTION FEATURE
91716-1571	93473-0006	CCT 5	NONE	NONE		OPEN	OPEN	NONE	NONE	LOCKING RETENTION FEATURE
91716-1572	93473-0006	NONE	NONE	d		OPEN	OPEN	NONE	PURPLE	LOCKING RETENTION FEATURE
91716-1573	91715-0006	CCT 2,5	NONE	c e g		OPEN	OPEN	NONE	RED	
91716-1574	91715-0406	NONE	NONE	a c e g		OPEN	OPEN	4&5	NONE	
91716-1575	91715-0106	NONE	NONE	a g		OPEN	OPEN	1&2	NONE	
91716-1576	91715-0106	CCT 3	NONE	b		OPEN	OPEN	1&2	NONE	
91716-1577	91715-9006	CCT 3	CCT 3	c d		OPEN	OPEN	1&2	BLUE	

### NOTES

- + DENOTES TERMINAL VOIDED POSITION  
⊕ DENOTES TERMINAL LOADED POSITION  
| DENOTES POLARIZING RIB POSITION
- MOLEX HOUSING NO. FOR REFERENCE ONLY

THIS DRAWING CONTAINS INFORMATION THAT IS PROPRIETARY TO MOLEX ELECTRONIC TECHNOLOGIES, LLC AND SHOULD NOT BE USED WITHOUT WRITTEN PERMISSION									
DIMENSION UNITS	SCALE	CURRENT REV DESC:							
mm	NTS								
GENERAL TOLERANCES (UNLESS SPECIFIED)		EC NO: 743071			APPLI-MATE 2.5 FEMALE (MATL: NYLON PA6)				
ANGULAR TOL	± 0.5°	DRWN: RAHULH3							
4 PLACES	±	CHK'D: RAHULH3			PRODUCT CUSTOMER DRAWING				
3 PLACES	± 0.05	APPR: MRAMAKRISHNA							
2 PLACES	± 0.1	INITIAL REVISION:			DOCUMENT NUMBER: 917160001 DOC TYPE: PSD DOC PART: 000 REVISION: N4				
1 PLACE	± 0.2	DRWN: CFISHER01							
0 PLACES	±	APPR: BRUTTLE			MATERIAL NUMBER: SEE TABLE CUSTOMER: GENERAL MARKET SHEET NUMBER: 6 OF 10				
DRAFT WHERE APPLICABLE MUST REMAIN WITHIN DIMENSIONS		THIRD ANGLE PROJECTION	DRAWING	SERIES					
			A2-SIZE	91716					

7 CIRCUIT										
PART NUMBER	HOUSING USED	TERMINAL VOID POSITION	LATCH POSITION	REMOVED POSITION KEYS	CONFIGURATION	FIRST ENDWALL	LAST ENDWALL	POLARIZING RIB BETWEEN	COLOUR STRIPE	
91716-2001	91715-0007	NONE	NONE	NONE		OPEN	OPEN	NONE	NONE	
91716-2002	91715-0207	NONE	NONE	ALL		OPEN	OPEN	2&3	NONE	
91716-2004	91715-0007	NONE	NONE	a		OPEN	OPEN	NONE	NONE	
91716-2005	91715-0007	CCT 2	NONE	h		OPEN	OPEN	NONE	NONE	
91716-2006	91715-0007	CCT 4	NONE	a		OPEN	OPEN	NONE	NONE	
91716-2007	91715-0007	CCT 2	NONE	NONE		OPEN	OPEN	NONE	NONE	
91716-2008	91715-0007	CCT 6	NONE	NONE		OPEN	OPEN	NONE	NONE	
91716-2009	91715-0007	CCT 2	NONE	b c e g		OPEN	OPEN	NONE	BLUE	
91716-2010	91715-0007	CCT 4,6	NONE	b d f		OPEN	OPEN	NONE	RED	
91716-2011	91715-0007	CCT 4,6	NONE	b d f		OPEN	OPEN	NONE	BLUE	
91716-2012	91715-0007	CCT 2	NONE	NONE		OPEN	OPEN	NONE	BLUE	
91716-2013	91715-0007	CCT 2	NONE	b d e f h		OPEN	OPEN	NONE	BLUE	
91716-2014	91715-0007	CCT 4,6	NONE	NONE		OPEN	OPEN	NONE	BLUE	
91716-2015	91715-0007	CCT 4,6	NONE	c d e f h		OPEN	OPEN	NONE	BLUE	
91716-2016	91715-0007	CCT 6	NONE	c d e f h		OPEN	OPEN	NONE	BLUE	
91716-2017	91715-0007	CCT 6	NONE	c d e f		OPEN	OPEN	NONE	BLUE	
91716-2018	91715-0007	CCT 6	NONE	NONE		OPEN	OPEN	NONE	BLUE	
91716-2019	91715-0007	CCT 2	NONE	NONE		OPEN	OPEN	NONE	BLACK	
91716-2020	91715-0007	NONE	NONE	a c e f h		OPEN	OPEN	NONE	NONE	
91716-2021	91715-0007	NONE	NONE	a		OPEN	OPEN	NONE	BLACK	
91716-2022	91715-0007	NONE	NONE	b c d f		OPEN	OPEN	NONE	NONE	
91716-2023	91715-0007	NONE	NONE	a d		OPEN	OPEN	NONE	NONE	
91716-2024	91715-0007	NONE	NONE	a b e f		OPEN	OPEN	NONE	NONE	
91716-2025	91715-0507	NONE	NONE	NONE		OPEN	OPEN	5&6	NONE	
91716-2026	91715-0007	NONE	NONE	ALL		OPEN	OPEN	NONE	NONE	
91716-2027	91715-0007	CCT 6	NONE	a c d e f		OPEN	OPEN	NONE	BLUE	
91716-2028	91715-0007	CCT 1,2,3,4,6	NONE	a c f		OPEN	OPEN	NONE	NONE	
91716-2029	91715-0007	CCT 4	NONE	a		OPEN	OPEN	NONE	RED	
91716-2030	93473-0307	NONE	NONE	ALL		OPEN	OPEN	3&4	NONE	LOCKING RETENTION FEATURE
91716-2031	91715-0307	NONE	NONE	ALL		OPEN	OPEN	3&4	NONE	

7 CIRCUIT										
PART NUMBER	HOUSING USED	TERMINAL VOID POSITION	LATCH POSITION	REMOVED POSITION KEYS	CONFIGURATION	FIRST ENDWALL	LAST ENDWALL	POLARIZING RIB BETWEEN	COLOUR STRIPE	
91716-2032	93473-0007	NONE	NONE	NONE		OPEN	OPEN	NONE	NONE	LOCKING RETENTION FEATURE
91716-2033	91715-0627	NONE	NONE	NONE		CLOSED	CLOSED	6&7	NONE	
91716-2034	91715-0007	NONE	NONE	b c d e f g		OPEN	OPEN	NONE	NONE	

N4  
N4

- NOTES
- + DENOTES TERMINAL VOIDED POSITION  
⊕ DENOTES TERMINAL LOADED POSITION  
| DENOTES POLARIZING RIB POSITION
  - MOLEX HOUSING NO. FOR REFERENCE ONLY

THIS DRAWING CONTAINS INFORMATION THAT IS PROPRIETARY TO MOLEX ELECTRONIC TECHNOLOGIES, LLC AND SHOULD NOT BE USED WITHOUT WRITTEN PERMISSION													
DIMENSION UNITS		SCALE		CURRENT REV DESC:									
mm		NTS											
GENERAL TOLERANCES (UNLESS SPECIFIED)				EC NO: 743071		2023/03/21		APPLI-MATE 2.5 FEMALE (MATL: NYLON PA6)					
ANGULAR TOL ± 0.5°				4 PLACES ±		DRWN: RAHULH3							
3 PLACES ± 0.05				3 PLACES ± 0.05		2023/03/21		PRODUCT CUSTOMER DRAWING					
2 PLACES ± 0.1				APPR: MRAMAKRISHNA		2023/03/21							
1 PLACE ± 0.2				INITIAL REVISION:				DOCUMENT NUMBER		DOC TYPE	DOC PART	REVISION	
0 PLACES ±				DRWN: CFISHER01		2016/05/06		917160001		PSD	000	N4	
DRAFT WHERE APPLICABLE MUST REMAIN WITHIN DIMENSIONS				THIRD ANGLE PROJECTION		DRAWING		SERIES		MATERIAL NUMBER		CUSTOMER	SHEET NUMBER
						A2-SIZE		91716		SEE TABLE		GENERAL MARKET	7 OF 10

# 8 CIRCUIT

PART NUMBER	HOUSING USED	TERMINAL VOID POSITION	LATCH POSITION	REMOVED POSITION KEYS	CONFIGURATION	FIRST ENDWALL	LAST ENDWALL	POLARIZING RIB BETWEEN	COLOUR STRIPE
91716-2501	91715-0008	NONE	NONE	NONE		OPEN	OPEN	NONE	NONE
91716-2502	91715-0308	NONE	NONE	NONE		OPEN	OPEN	3&4	NONE
91716-2503	91715-0008	NONE	NONE	cfhi		OPEN	OPEN	NONE	NONE
91716-2504	91715-0008	NONE	NONE	bcdhi		OPEN	OPEN	NONE	NONE
91716-2505	91715-0008	NONE	NONE	bcgh		OPEN	OPEN	NONE	BLUE
91716-2506	91715-0008	NONE	NONE	cf		OPEN	OPEN	NONE	NONE
91716-2507	91715-0008	NONE	NONE	cfhi		OPEN	OPEN	NONE	BLUE
91716-2508	91715-0008	NONE	NONE	NONE		OPEN	OPEN	NONE	BLUE
91716-2509	91715-0008	NONE	NONE	acdegi		OPEN	OPEN	NONE	BLUE
91716-2510	91715-0008	NONE	NONE	cdef		OPEN	OPEN	NONE	BLUE
91716-2511	91715-0008	NONE	NONE	NONE		OPEN	OPEN	NONE	BLACK
91716-2512	91715-0008	NONE	NONE	cfhi		OPEN	OPEN	NONE	BLACK
91716-2513	91715-0008	NONE	NONE	cdgh		OPEN	OPEN	NONE	NONE
91716-2514	91715-0008	NONE	NONE	acdefghi		OPEN	OPEN	NONE	BLUE
91716-2515	91715-0008	NONE	NONE	abdfhi		OPEN	OPEN	NONE	NONE
91716-2516	91715-0008	NONE	NONE	bcdhi		OPEN	OPEN	NONE	BLUE
91716-2517	91715-2008	NONE	NONE	NONE		OPEN	OPEN	1&2, 7&8	NONE
91716-2518	91715-0008	NONE	NONE	bcdghi		OPEN	OPEN	NONE	NONE
91716-2519	91715-0008	NONE	NONE	acefhi		OPEN	OPEN	NONE	NONE
91716-2520	91715-0008	NONE	NONE	ALL		OPEN	OPEN	NONE	NONE
91716-2521	91715-0008	CCT 7 & 8	NONE	abdfhi		OPEN	OPEN	NONE	NONE
91716-2522	91715-0008	NONE	NONE	bcdghi		OPEN	OPEN	NONE	BLUE
91716-2523	91715-0008	CCT 2, 4 & 6	NONE	acdefg		OPEN	OPEN	NONE	NONE
91716-2524	91715-0068	CCT 2, 4 & 6	NONE	acdefg		CLOSED	OPEN	NONE	BROWN
91716-2525	91715-2108	NONE	NONE	ai		OPEN	OPEN	1&2, 6&7	NONE

# 9 CIRCUIT

PART NUMBER	HOUSING USED	TERMINAL VOID POSITION	LATCH POSITION	REMOVED POSITION KEYS	CONFIGURATION	FIRST ENDWALL	LAST ENDWALL	POLARIZING RIB BETWEEN	COLOUR STRIPE
91716-3001	91715-0009	NONE	NONE	NONE		OPEN	OPEN	NONE	NONE
91716-3002	91715-0409	NONE	NONE	NONE		OPEN	OPEN	4&5	NONE
91716-3003	91715-0009	CCT 2,5,8	NONE	NONE		OPEN	OPEN	NONE	NONE
91716-3004	91715-0209	NONE	NONE	NONE		OPEN	OPEN	2&3	NONE
91716-3005	91715-0009	CCT 2,5,8	NONE	bcegi j		OPEN	OPEN	NONE	GREEN
91716-3006	91715-0009	CCT 2,5,8	NONE	NONE		OPEN	OPEN	NONE	GREEN
91716-3007	91715-0009	CCT 2,5,8	NONE	bcefgij		OPEN	OPEN	NONE	GREEN
91716-3008	91715-0009	CCT 2,5,8	NONE	bcefgi		OPEN	OPEN	NONE	GREEN
91716-3009	91715-0009	CCT 2,5,7	NONE	cg		OPEN	OPEN	NONE	NONE
91716-3010	91715-0009	CCT 2,5,8	NONE	bchi		OPEN	OPEN	NONE	NONE
91716-3011	91715-0709	NONE	NONE	NONE		OPEN	OPEN	7&8	NONE
91716-3012	91715-0509	NONE	NONE	NONE		OPEN	OPEN	5&6	NONE
91716-3013	91715-0029	NONE	NONE	NONE		CLOSED	CLOSED	NONE	NONE

### NOTES

- + DENOTES TERMINAL VOIDED POSITION  
⊕ DENOTES TERMINAL LOADED POSITION  
| DENOTES POLARIZING RIB POSITION
- MOLEX HOUSING NO. FOR REFERENCE ONLY

THIS DRAWING CONTAINS INFORMATION THAT IS PROPRIETARY TO MOLEX ELECTRONIC TECHNOLOGIES, LLC AND SHOULD NOT BE USED WITHOUT WRITTEN PERMISSION

DIMENSION UNITS	SCALE	CURRENT REV DESC:					
mm	NTS						
GENERAL TOLERANCES (UNLESS SPECIFIED)				APPLI-MATE 2.5 FEMALE (MATL: NYLON PA6)			
ANGULAR TOL ± 0.5°							
4 PLACES	±	EC NO: 743071	2023/03/21	PRODUCT CUSTOMER DRAWING			
3 PLACES	± 0.05	DRWN: RAHULH3	2023/03/21				
2 PLACES	± 0.1	CHK'D: RAHULH3	2023/03/21				
1 PLACE	± 0.2	APPR: MRAMAKRISHNA	2023/03/21	DOCUMENT NUMBER: 917160001 DOC TYPE: PSD DOC PART: 000 REVISION: N4			
0 PLACES	±	INITIAL REVISION:					
DRAFT WHERE APPLICABLE MUST REMAIN WITHIN DIMENSIONS		THIRD ANGLE PROJECTION	DRAWING: A2-SIZE	SERIES: 91716	MATERIAL NUMBER: SEE TABLE	CUSTOMER: GENERAL MARKET	SHEET NUMBER: 8 OF 10



### 10 CIRCUIT

PART NUMBER	HOUSING USED	TERMINAL VOID POSITION	LATCH POSITION	REMOVED POSITION KEYS	CONFIGURATION	FIRST ENDWALL	LAST ENDWALL	POLARIZING RIB BETWEEN	COLOUR STRIPE
91716-3501	91715-0010	NONE	NONE	NONE		OPEN	OPEN	NONE	NONE
91716-3502	91715-0210	NONE	NONE	ALL		OPEN	OPEN	2&3	NONE
91716-3503	91715-0010	Cct 2,5,7,9	NONE	NONE		OPEN	OPEN	NONE	NONE
91716-3504	91715-0410	NONE	NONE	NONE		OPEN	OPEN	4&5	NONE
91716-3505	91715-0010	NONE	NONE	b c d e f g h i j		OPEN	OPEN	NONE	NONE
91716-3506	91715-0010	NONE	NONE	a		OPEN	OPEN	NONE	NONE

### 11 CIRCUIT

PART NUMBER	HOUSING USED	TERMINAL VOID POSITION	LATCH POSITION	REMOVED POSITION KEYS	CONFIGURATION	FIRST ENDWALL	LAST ENDWALL	POLARIZING RIB BETWEEN	COLOUR STRIPE
91716-4001	91715-0011	NONE	NONE	NONE		OPEN	OPEN	NONE	NONE
91716-4002	91715-0031	NONE	NONE	NONE		CLOSED	CLOSED	NONE	NONE
91716-4003	91715-0511	NONE	NONE	NONE		OPEN	OPEN	5&6	NONE
91716-4004	91715-1031	NONE	NONE	NONE		CLOSED	CLOSED	10&11	NONE
91716-4005	91715-1011	NONE	NONE	NONE		OPEN	OPEN	10&11	NONE
91716-4006	91715-0011	CCT 5,6,7	NONE	NONE		OPEN	OPEN	NONE	NONE
91716-4007	91715-0011	CCT 5,6,7	NONE	a d e f h i j l		OPEN	OPEN	NONE	NONE
91716-4008	91715-0011	CCT 5,6,7	NONE	a b e f g i j k		OPEN	OPEN	NONE	NONE
91716-4009	91715-0011	NONE	NONE	b c d e f g h i j k		OPEN	OPEN	NONE	NONE

### 12 CIRCUIT

PART NUMBER	HOUSING USED	TERMINAL VOID POSITION	LATCH POSITION	REMOVED POSITION KEYS	CONFIGURATION	FIRST ENDWALL	LAST ENDWALL	POLARIZING RIB BETWEEN	COLOUR STRIPE
91716-4501	91715-0012	NONE	NONE	NONE		OPEN	OPEN	NONE	NONE
91716-4502	91715-0012	CCT 2,5,8,11	NONE	b c d e j k l		OPEN	OPEN	NONE	GREEN
91716-4503	91715-0012	CCT 2,5,8,11	NONE	NONE		OPEN	OPEN	NONE	GREEN
91716-4504	91715-0012	CCT 2,5,8,11	NONE	a c d e g h i k l m		OPEN	OPEN	NONE	GREEN
91716-4505	91715-0012	CCT 2,5,8,11	NONE	c d e g h i k l m		OPEN	OPEN	NONE	GREEN

#### NOTES

- + DENOTES TERMINAL VOIDED POSITION  
⊕ DENOTES TERMINAL LOADED POSITION  
| DENOTES POLARIZING RIB POSITION
- MOLEX HOUSING NO. FOR REFERENCE ONLY

### 13 CIRCUIT

PART NUMBER	HOUSING USED	TERMINAL VOID POSITION	LATCH POSITION	REMOVED POSITION KEYS	CONFIGURATION	FIRST ENDWALL	LAST ENDWALL	POLARIZING RIB BETWEEN	COLOUR STRIPE
91716-5001	91715-0013	NONE	NONE	NONE		OPEN	OPEN	NONE	NONE
91716-5002	91715-0013	CCT 4,6,8,10,12	NONE	NONE		OPEN	OPEN	NONE	NONE
91716-5003	91715-0013	NONE	NONE	c f h i k l		OPEN	OPEN	NONE	NONE

### 14 CIRCUIT

PART NUMBER	HOUSING USED	TERMINAL VOID POSITION	LATCH POSITION	REMOVED POSITION KEYS	CONFIGURATION	FIRST ENDWALL	LAST ENDWALL	POLARIZING RIB BETWEEN	COLOUR STRIPE
91716-5501	91715-0014	NONE	NONE	NONE		OPEN	OPEN	NONE	NONE

### 15 CIRCUIT

PART NUMBER	HOUSING USED	TERMINAL VOID POSITION	LATCH POSITION	REMOVED POSITION KEYS	CONFIGURATION	FIRST ENDWALL	LAST ENDWALL	POLARIZING RIB BETWEEN	COLOUR STRIPE
91716-6001	91715-0015	NONE	NONE	NONE		OPEN	OPEN	NONE	NONE
91716-6002	91715-0015	CCT 4,6,8,10,12,14	NONE	o p		OPEN	OPEN	NONE	NONE
91716-6003	91715-0515	NONE	NONE	a p		OPEN	OPEN	5&6	NONE

THIS DRAWING CONTAINS INFORMATION THAT IS PROPRIETARY TO MOLEX ELECTRONIC TECHNOLOGIES, LLC AND SHOULD NOT BE USED WITHOUT WRITTEN PERMISSION

DIMENSION UNITS	SCALE	CURRENT REV DESC:		<b>molex</b>			
mm	NTS						
GENERAL TOLERANCES (UNLESS SPECIFIED)		EC NO: 743071		APPLI-MATE 2.5 FEMALE (MATL: NYLON PA6)			
ANGULAR TOL ± 0.5°		DRWN: RAHULH3 2023/03/21					
4 PLACES ±		CHK'D: RAHULH3 2023/03/21		PRODUCT CUSTOMER DRAWING			
3 PLACES ± 0.05		APPR: MRAMAKRISHNA 2023/03/21					
2 PLACES ± 0.1		INITIAL REVISION:		DOCUMENT NUMBER			
1 PLACE ± 0.2		DRWN: CFISHER01 2016/05/06					
0 PLACES ±		APPR: BRUTTLE 2016/07/01		917160001			
DRAFT WHERE APPLICABLE MUST REMAIN WITHIN DIMENSIONS		THIRD ANGLE PROJECTION					
DRAWING		SERIES		MATERIAL NUMBER			
A2-SIZE		91716					
SEE TABLE		GENERAL MARKET		SHEET NUMBER			
9 OF 10							

### 16 CIRCUIT

PART NUMBER	HOUSING USED	TERMINAL VOID POITION	LATCH POSITION	REMOVED POSITION KEYS	CONFIGURATION	FIRST ENDWALL	LAST ENDWALL	POLARIZING RIB BETWEEN	COLOUR STRIPE
91716-6501	91715-0016	NONE	NONE	NONE		OPEN	OPEN	NONE	NONE
91716-6502	91715-0416	NONE	NONE	NONE		OPEN	OPEN	4&5	NONE
91716-6503	91715-7076	CCT 2 & 15	CCT 2 & 15	NONE		CLOSED	OPEN	NONE	NONE

### 17 CIRCUIT

PART NUMBER	HOUSING USED	TERMINAL VOID POITION	LATCH POSITION	REMOVED POSITION KEYS	CONFIGURATION	FIRST ENDWALL	LAST ENDWALL	POLARIZING RIB BETWEEN	COLOUR STRIPE
91716-7001	91715-0017	NONE	NONE	NONE		OPEN	OPEN	NONE	NONE

### 18 CIRCUIT

PART NUMBER	HOUSING USED	TERMINAL VOID POITION	LATCH POSITION	REMOVED POSITION KEYS	CONFIGURATION	FIRST ENDWALL	LAST ENDWALL	POLARIZING RIB BETWEEN	COLOUR STRIPE
91716-7501	91715-0018	NONE	NONE	NONE		OPEN	OPEN	NONE	NONE

### 19 CIRCUIT

PART NUMBER	HOUSING USED	TERMINAL VOID POITION	LATCH POSITION	REMOVED POSITION KEYS	CONFIGURATION	FIRST ENDWALL	LAST ENDWALL	POLARIZING RIB BETWEEN	COLOUR STRIPE
91716-8001	91715-0019	NONE	NONE	NONE		OPEN	OPEN	NONE	NONE

### 20 CIRCUIT

PART NUMBER	HOUSING USED	TERMINAL VOID POITION	LATCH POSITION	REMOVED POSITION KEYS	CONFIGURATION	FIRST ENDWALL	LAST ENDWALL	POLARIZING RIB BETWEEN	COLOUR STRIPE
91716-8501	91715-0020	NONE	NONE	NONE		OPEN	OPEN	NONE	NONE

#### NOTES

- + DENOTES TERMINAL VOIDED POSITION  
⊕ DENOTES TERMINAL LOADED POSITION  
| DENOTES POLARIZING RIB POSITION
- MOLEX HOUSING NO. FOR REFERENCE ONLY

THIS DRAWING CONTAINS INFORMATION THAT IS PROPRIETARY TO MOLEX ELECTRONIC TECHNOLOGIES, LLC AND SHOULD NOT BE USED WITHOUT WRITTEN PERMISSION									
DIMENSION UNITS	SCALE	CURRENT REV DESC:							
mm	NTS								
GENERAL TOLERANCES (UNLESS SPECIFIED)		EC NO: 743071				APPLI-MATE 2.5 FEMALE (MATL: NYLON PA6)			
ANGULAR TOL ± 0.5°		DRWN: RAHULH3 2023/03/21							
4 PLACES ±		CHK'D: RAHULH3 2023/03/21				PRODUCT CUSTOMER DRAWING			
3 PLACES ± 0.05		APPR: MRAMAKRISHNA 2023/03/21							
2 PLACES ± 0.1		INITIAL REVISION:				DOCUMENT NUMBER: 917160001 DOC TYPE: PSD DOC PART: 000 REVISION: N4			
1 PLACE ± 0.2		DRWN: CFISHER01 2016/05/06							
0 PLACES ±		APPR: BRUTTLE 2016/07/01							
DRAFT WHERE APPLICABLE MUST REMAIN WITHIN DIMENSIONS		THIRD ANGLE PROJECTION	DRAWING	SERIES	MATERIAL NUMBER	CUSTOMER		SHEET NUMBER	
			A2-SIZE	91716	SEE TABLE	GENERAL MARKET		10 OF 10	

DOCUMENT STATUS	P1	RELEASE DATE	2023/03/21	09:38:20
-----------------	----	--------------	------------	----------